

CLAS[®]
GARAGE SOLUTIONS



TRUCK EDITION

Every day, we work
hard to meet your
needs and provide
you tailor-made
SOLUTIONS that save
you **energy** and **time**.

19/20

Edito

Hello,

After a year rich in movement and adaptation to this evolving market, 2020 looks set to be the same.

We affirm our positions by offering a wider range of tools and equipment, going beyond our flagship ranges that have made us strong and built our DNA.

We are therefore proud to be able to offer you an extensive portfolio of new products by teaming up with key new partners, the German ATH-Heinl and the Italian ITM.

As a creator of synergies, these relationships have naturally been established insofar as we share common values: proximity, efficiency,

simplicity and dynamism.

Moreover, offering an irreproachable and responsive service is our priority.

That is why we have invested in a new automated storage management tool and a website with new functionalities.

Our team is constantly trying to improve to satisfy you, our customers and partners. It is a story of Tools but also a story of People.

The CLAS team



“

*As for the **future**, your task is not to foresee it, but to enable it*

”

Antoine de St Exupéry



clas.com !



Find the full range of our products and much more by scanning this code!



Our commercial actions

Throughout the year, we offer you selections of products at preferential rates!

These quarterly printouts are available from your closest distributor.



Social media



facebook.com/CLASequipment/



Channel: CLAS Equipements



linkedin.com/company/clas-equipements

New pictograms

We started last year, here is the complement for the other categories in the catalog.

They are there to make it easier for you to read, to help you quickly find the product range you are looking for..

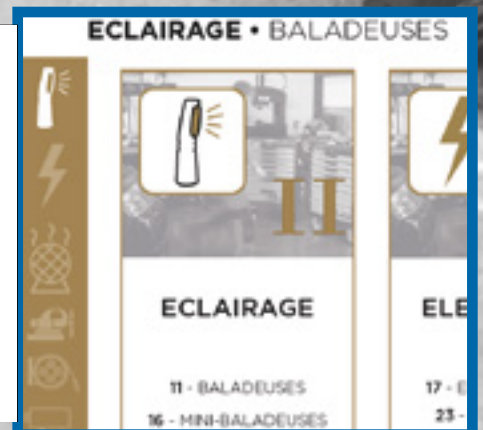

New ranges

New this year: several ranges have been added to our catalog to complete our offer:

- **post lifts**
- **air pipe and fitting kit**
- **workshop heaters**

NEW



WMS installation

New automated storage management tool to be faster during preparation and shipping times.

NEW

LV & HGV Catalogs

This is the second year now that we are offering two catalogs, one LV catalog and one HGV catalog.

You will find common parts for the general equipment, the technical part being dedicated to each type of vehicle.

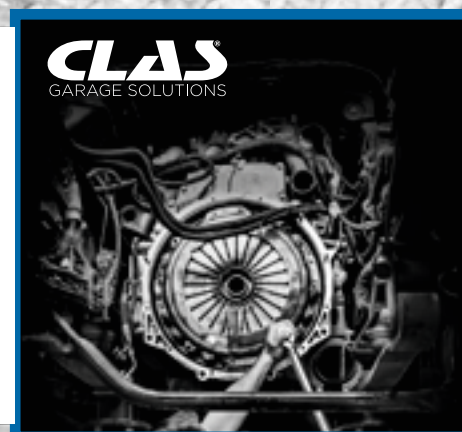

Technical support

Our trucks travel all over France and abroad to be as close as possible to you: garage demonstrations, technical support...

SUMMARY



WORKSHOP SOLUTIONS



11 - LIGHTING



19 - ELECTRICITY



30 - HEATER



39 - GENERAL TOOLS



66 - REELS



74 - PNEUMATIC TOOLS



95 - HANDTOOLS



150 - LIFTING & PRESSES



169 - LUBRICATION & SPILL CONTAINMENT



177 - CLEANING



183 - EXHAUST GAS INHALATION

TECHNICAL SOLUTIONS



189 - FUEL



195 - OIL



200 - COOLING SYSTEM



204 - ENGINE BAY



232 - CLUTCH/GEARBOX



240 - START & LOAD



246 - AIRCON



252 - BRAKING



266 - STEERING/SUSPENSION



276 - EXTRACTION



285 - WHEEL



299 - WHEEL BALANCERS/TIRE CHANGERS



316 - LIFTING RAMPS

BODY REPAIR SOLUTIONS



321 - TROLLEYS & STORAGE



325 - WELDING



329 - SCOURING



335 - PAINTING



341 - STRAIGHTENING



344 - PAINTLESS DENT REMOVAL



347 - DOORS & CABIN



350 - CLEANING



355 - GLAZING



367 - HEADLIGHT



371 - PLASTIC



375 - DRILLING

PRODUCTS



CLAS rewarded!

Every year, Decision Atelier magazine organizes a competition among equipment manufacturers: the Equipment of the Year Award.

We registered our new HGV hub caliper and we are proud that it was awarded in its category.

What are its strengths?

Specially designed to extract the entire hub (hub, disc and caliper) in one piece, and disassemble it effortlessly directly on the support.

The solution is innovative because it is 3 in 1: support, lifting & handling of the hub block/brake system.

Everything is designed so that the operator can carry out all the operations necessary for his intervention directly on the support, effortless.

No more heavy parts falling or falling, no more 2 or 3 operators working to secure...

Discover it and also the rest of our HGV products in our dedicated catalog!



Ref. OH 8010



IN FIGURES!

1996

YEAR

of creation of the company

311

NEW

products in the catalog

68000

CATALOGS

printed this year

1000000

**LV & HGV
COMMERCIAL**

brochures published

5500

REFERENCES

in stock

47

COUNTRIES

distributing the brand



WORKSHOP SOLUTIONS

11

LIGHTING

- 11 - PORTABLE LIGHTS
- 16 - MINI LAMPS
- 17 - RAMPS



19

ELECTRICITY

- 19 - ELECTRONIC
- 25 - PROTECTION



30

GENERAL TOOLS

- 30 - HEATER
- 39 - WORKSHOP FURNITURE
- 41 - EQUIPMENT
- 43 - DRILLING
- 47 - CONSUMABLE
- 51 - SCRAPERS AND UTILITY KNIVES
- 52 - CONTROL/MEASUREMENT
- 56 - INDUCTION
- 58 - AIR COMPRESSORS
- 62 - AIR SYSTEM



66

REELS

- 66 - ELECTRICAL
- 69 - AIR & WATER
- 73 - OIL - GREASE



74

PNEUMATIC TOOLS

- 74 - CONNECTORS
- 76 - BLOWGUNS
- 77 - TIGHTNESS/RELEASE
- 81 - DRILLING
- 83 - CUTTING
- 85 - GRINDER
- 87 - SANDER
- 90 - GUNS
- 92 - PAINTING
- 93 - BLASTING
- 94 - CLEANING



95

HANDTOOLS

- 95 - STORAGE
- 102 - CONTENTS & INSERTS
- 107 - RATCHETS
- 127 - DYNAMOMETRY
- 129 - TIGHTENING KEYS
- 132 - PLIERS
- 136 - BITS
- 145 - HAMMERING TOOLS



150

LIFTING & PRESSES

- 150 - PRESSES
- 153 - CRANES
- 155 - JACK STANDS
- 157 - JACKS
- 166 - PADS & BLOCKS



169

LUBRICATION & SPILL CONTAINMENT

- 169 - TRAYS
- 170 - DISTRIBUTION/PUMP
- 174 - SPILL CONTAINMENT



177

CLEANING

- 177 - VACUUMS
- 178 - SPRAYERS
- 181 - FOUNTAINS
- 182 - CLEANING AGENT



183

EXHAUST GAS INHALATION

- 183 - PNEUMATIC
- 185 - ELECTRICAL

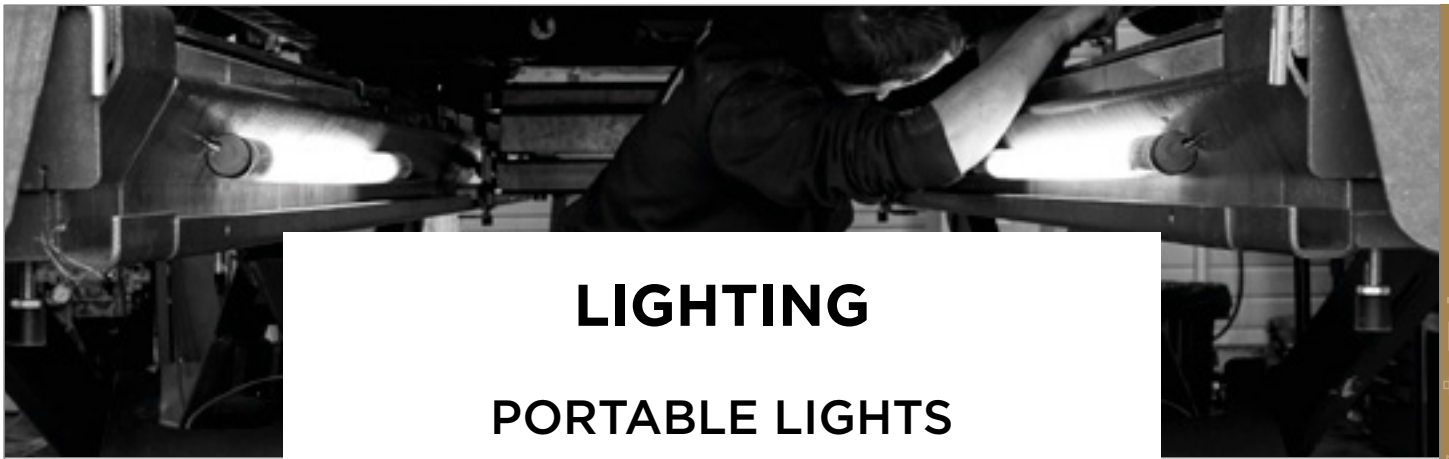

LIGHTING

PORTABLE LIGHTS



OE 0144

RECHARGEABLE PORTABLE LIGHT 6W COB IK07

Aluminum/ABS/rubber shock-resistant body.
Portable lamp with a strong magnet on the base.



- 6W COB to the front + 2W CREE at the top
- 2 luminance intensities: 350-600lm
- 360° swiveling hook
- 180° rotating base
- charge indicator
- autonomous operation: 3.5h
- charging time: 4h
- li-ion battery 3.7V-2600mAh
- wall charger with USB socket





OE 0131

RECHARGEABLE PORTABLE ARTICULATED LIGHT IK08

Mini pocket lamp
Stainless steel pen clip on the back of the case

NEW



Specifications:

- 3W COB on the front + 1W on the top
- luminous intensities on the front panel 2 positions 100 - 250 lumens
- luminous intensity at the top 60 lumens
- 180° rotating base
- autonomy: 3.5h
- Lithium battery 3.7V 700mAh
- LED charging indicator, red - charging, green - full
- loading time: 3h
- rechargeable via USB cable included

OE 0132 CHARGING BASE

Spare part of OE 0131



OE 0143

ULTRATHIN CORDLESS RECHARGEABLE LAMP WITH VARIABLE INTENSITY 7W IK07

Lamp equipped with a dimmer, allowing an optimal intensity adjustment in all situations. The headlight can be used alone or simultaneously with the front lighting thanks to the separate switch.



Dimmer



- impact-resistant ABS body with rubber coating for perfect grip
- ultra thin head: 21x11mm
- 7W COB at the front + 3W at the top
- light intensity: 60 to 600lm adjustable by dimmer
- separate headlamp light switch
- 360° swivel hook
- magnetic base on 45° tilt ball swivel + 360° rotation
- load indicator
- autonomy: 2 to 16h (depending on intensity)
- charging time: 4h
- li-ion 3.7V-2600mAh Li-ion battery
- aC charger + USB plug
- dimensions: 384x40x45mm

OE 0143R

ULTRATHIN CORDLESS RECHARGEABLE LAMP WITH VARIABLE INTENSITY RED









OE 0145BL

ULTRATHIN CORDLESS RECHARGEABLE LAMP WITH VARIABLE INTENSITY

B.LINE

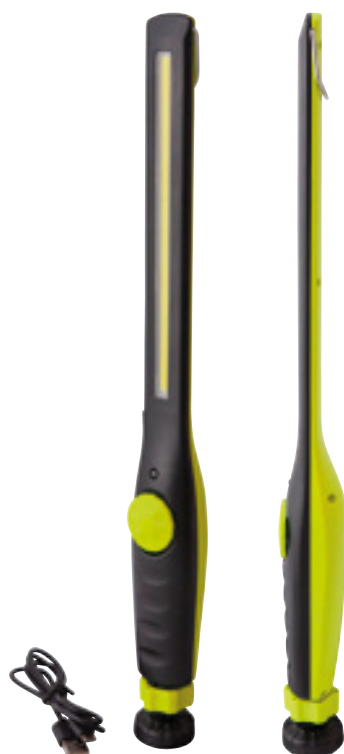

NEW



Hand lamp equipped with a dimmer. Rechargeable via USB cable provided.

Specifications:

- COB technology
- ultra thin head: 23x14mm
- light intensity: max. 600lm adjustable by dimmer
- magnetic base on swivel tiltable 45° + 360° rotating
- autonomy: 2 to 10 hours (depending on intensity)
- charging time: 4h
- Lithium battery 3.7V-2600mAh
- rechargeable via USB cable included
- dimensions: 384x40x40x45mm







OE 0042

NEON PORTABLE LIGHT

- ultra compact
- energy saving
- electronic control board in the grip



SA 9042	GLASS COVER	Spare part of OE 0042
OE 0086	2 PIN FLUORESCENT STRIP LIGHT 11W 220V	Spare part of OE 0042/OE 0044/OE 0048/OE 0049
SA 9043	220V PLATE	Spare part of OE 0042

OE 0017BL

PORTABLE CAGE LIGHT

12-24-220V

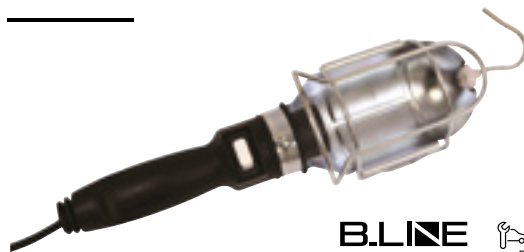

B.LINE



- E27 screw-type socket
- 2x0.75mm² H05WF
- 12V-24V-220V supply possible
- bulb-free
- domestic use

OE 0098

WIRED 30 LED PORTABLE LAMP

12-24V AC-DC

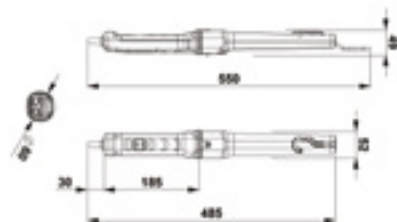

- 150 lumens (~20% brightness in DC)
- ultra compact
- energy saving
- electronic control board in the grip
- cable H05 RNF 10m
- plug not included

Standards EN 60598-2-8 CEI 598-2-10

SA 9022	24V PLATE	Spare part of OE 0098
SA 9280	16A 24V HYPRASOCKET	Spare part of OE 0094/OE 0098
SA 9004	GLASS COVER	Spare part of OE 0093/OE 0094/OE 0098/OE 1315/OE 0095
SA 9021	48 LED RAMP	Spare part of OE 0098/OE 0095
SA 9003	BLACK HOOK+HOLDER	Spare part of OE 0093/OE 0094/OE 0098/OE 1315/OE 0095

OE 0094

WIRED FLUORESCENT PORTABLE LAMP

This lamp has a service life which is 8 times longer than a traditional incandescent lamp. It does not get warm and has a high luminosity.

24V AC-DC



- ultra compact
- energy saving
- 900 lumens
- electronic control board
- protected switch
- rotative and adjustable hook
- cable H05 RNF 10m
- supplied without plug

Standards
 EN 60598-1- EN 60598-2-8-EN 60335-1
 2006/95/CE-2004/108/CE-2002/95/CE

SA 9023	24V PLATE	Spare part of OE 0094
OE 0085	FLUORESCENT STRIP LIGHT 11W 2G7	Spare part of OE 0093/OE 0094/OE 1314/OE 1361/OE 1360/OE 1225
SA 9280	16A 24V HYPRASOCKET	Spare part of OE 0094/OE 0098
SA 9004	GLASS COVER	Spare part of OE 0093/OE 0094/OE 0098/OE 1315/OE 0095
SA 9003	BLACK HOOK+HOLDER	Spare part of OE 0093/OE 0094/OE 0098/OE 1315/OE 0095

IP 65 **10 m** **24V** **11 W** **1** WARRANTY



MINI LAMPS

OE 0395

MINI RECHARGEABLE INSPECTION LAMP
3W COB+1SMD



Compact: 3 in 1



Specifications:

- aluminum body
- 2 magnets + belt clip
- triple illumination: 3W COB to the front + 1W SMD at the top + UV to the front
- luminance intensity: 250lm to the front, 70lm at the top
- LED UV
- UV wavelength: 390-400nm
- overheating and overloading protection
- autonomous operation: 3.5-10h (at the top)
- charging time: 3-4h
- charge indicator
- battery: 3.6V 2200m
- Ah- 220V mains charger
- dimensions: L.111xW.27xH.24mm



OE 0396

UV MINI RECHARGEABLE INSPECTION LAMP



Specifications:

- aluminum body
- 2 magnets + belt clip
- double illumination: to the front + at the top
- LED UV
- UV wavelength: 390-400nm
- overheating and overloading protection
- autonomous operation: 3.5h
- charging time: 3-4h
- charge indicator
- battery: 3.6V 2200mAh
- 220V mains charger
- dimensions: L.111xW.27xH.24mm



OE 0129

360° IK07 MINI LAMP

NEW



Compact lamp,
Stainless steel pen clip on the back of the case.

Specifications :

- 2W COB on front + 3W 1818 SMD high quality LED on top
- luminous intensities on the front panel 2 positions 100 - 200 lumens
- luminous intensity at the top 120 lumens
- dimensions: 175x20x20x25mm

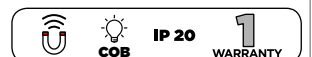

OE 0055

**HEADLAMP MAGNETIC SUPPORT
RECHARGEABLE 480Lm**

Articulated headlamp, detachable, magnetic.
Equipped with a motion detector allowing the lamp to be illuminated or switched off when the hand passes through. Rechargeable via USB cable provided.

NEW



Specifications:

- Cree led + COB technology
- 4 powers from 90 to 480 lumens
- battery 3.7 1400 Mah Lithium Polymer
- charging time: about 3 hours

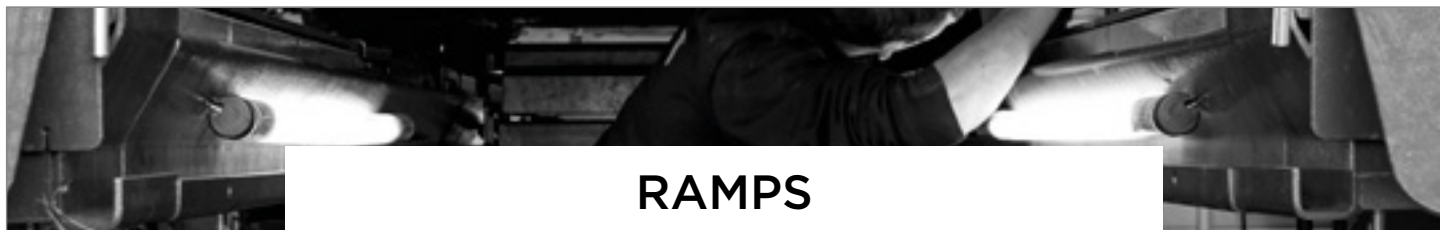

RAMPS

OE 0178

RECHARGEABLE ALUMINUM RAMP 32 LED IK07

IK07: high impact resistance



Specifications:

- adjustable aluminium frame, length 115-180cm
- anti-scratch hooks width 60mm
- 180° light scattering without shadow area
- 2 light intensities: 500-1000 lumens
- 180° swivel ramp
- battery: 3.7V 4400mAh Li-ion
- charging time: 4h
- autonomy: 3-6h



INGRESS PROTECTION RATIN

MORE

1st digit: Solid particle protection

- 0 No protection
- 1 Protected against solid particles superior to 50mm
- 2 Protected against solid particles superior to 12mm
- 3 Protected against solid particles superior to 2.5mm
- 4 Protected against solid particles superior to 1mm
- 5 Dust protected
- 6 Dust tight

2nd digit : Liquid ingress protection

- 0 No protection
- 1 Protected against dripping water
- 2 Protected against dripping water when tilted up to 15° from the vertical
- 3 Protected against spraying water when tilted up to 60° from the vertical
- 4 Protected against splashing water jets from any direction
- 5 Protected against water jets from any direction by a nozzle
- 6 Protected against powerful water jets from any direction
- 7 Protected against immersion
- 8 Protected against long-lasting immersion according to speci ed conditions

EXTRACT FROM THE RoHS DIRECTIVE (EUROPE)

MORE

To enforce the European Directive 2002/95/EC on the restriction of the use of certain hazardous substances in electrical and electronic equipments (commonly referred to as the Restriction of Hazardous Substances Directive or RoHS), the maximum permitted concentrations were fixed on August 18th, 2005 by an European commission decision (Published in the European Union Official Journal, L 214 dated August 19th, 2005 - 2005/618/CE.)

From July 1st, 2006, according to the RoHS directive requirements, producers (manufacturers, importers or distributors selling under their own brand) that launch on the market electric or electronic equipments must ensure that the following hazardous materials they could contain, doesn't exceed the maximum permitted concentrations as follows, by weight of homogeneous material :

Hazardous Substances	Maximum values
Cadmium (Cd)	100 mg/kg 0,01 %
Lead (Pb)	1000 mg/kg 0,1 %
Mercury (Hg)	1000 mg/kg 0,1 %
Hexavalent chromium (Cr (VI))	1000 mg/kg 0,1 %
Polybrominated biphenyls (PBB)	1000 mg/kg 0,1 %
Polybrominated diphenyl ether (PBDE)	1000 mg/kg 0,1 %

We certify that our electrical equipments (inspection lamps) comply with this directive.

EXTRACT FROM THE LABOUR CODE (FRANCE)

MORE

According to the employment regulation, the only inspection lamps that can be used in rooms subject to labour code must comply with following standards: EN60598-2-8 (CEI 598-2-8) IP45 mini.

ELECTRICITY

ELECTRONIC

AC 511

12V RELAY TESTER

Allows you to test electromechanical relays fast and accurately. Saves operator time and gives a reliable diagnosis.



Suitable for 4 or 5 pin relays

Specifications:

- power surge protection
- suitable for diode relays
- LED result display
- test voltage 12V
- power supply via crocodile clips



OE 3030

FUSE TESTER 6-12-24V

This two-in-one tester allows to check quickly fuses on spindles and to extract them easily.

Suitable for mini, standard and maxi fuses of 6,12 and 24V. This tool is adjustable according to fuses. The LED will illuminate if the fuse being checked is in order.

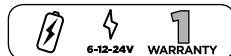

EG 0526

120 PCS 5-30A FUSE SET



Contents:

- 20x05A
- 20x10A
- 20x15A
- 20x20A
- 20x25A
- 20x30A



OM 9392

STRAIGHT NOSE PLIERS



OM 9393

90° ELBOW NOSE PLIERS

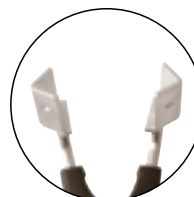

OM 2002

PULLER FOR EXTRACTING CONNECTION PLUGS SET

Allows the data sheets from sensors for coolant liquid, connector calculators, wiring harnesses to be extracted... Compatible with VAG connectors.



OM 0205

CAR-RADIO REMOVAL TOOL KIT

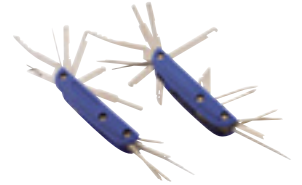

OE 3025

SENSOR SIMULATOR



Specifications:

- This device is used to simulate:
- resilience
- tension
- sinusoidal wave
- square wave
- temperature coefficient sensors
- butterfly and pedal sensor
- oxygen sensor or in test mode

By the time you have replaced two unnecessary sensors, the device is profitable



OE 3020

MULTIFUNCTION TESTER 0-50V



Allows a multitude of tests:

- voltmeter
- ammeter (without removing the fuses)
- ohmmeter
- continuity tester
- leakage current
- voltage drop at start-up
- battery tester
- alternator and starter
- fuses test for Mini, ATC, Maxi

Frequency measurement function (oscilloscope) in Hz or %.
Values displayed in Green/Orange/Red: simplified interpretation

Specifications:

- capacity: 0 to 50V
- resistance: 0-1Mohm
- battery test: 12-24V
- frequency: 0-20KHz
- diode test
- case and cables protected by fuses
- stores the max voltage in test voltage drop at start

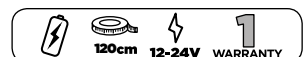

OE 0811**SOLDERING IRON 30W WITH STAND**

This soldering iron is ideal for a multitude of works. The high quality tips are suitable for lead-free soldering.



Delivered with tin, tips and sponge

The work stand has two crocodile clips for holding electronic boards.
Weight: 560g

**EG 0050****PORTABLE GAS SOLDERING IRON****Specifications:**

- solder up to 500°C
- 4-position adjustment
- supplied with 4 tips
- after-use support
- piezo ignition

SA0811: 100g tin
EG0047: Butane gas (not included)

**OE 6047****HOT AIR GUN 50-650°C****Specifications:**

- LCD display
- last temperature memorized
- 5 options for airflow from 250 to 500l/min
- heat constant control (protects against overheating and ensures a continuous job)
- handle for a comfortable job
- operating temperature range: 50-650°C

Supplied with:

- 1 protective nozzle
- 1 flat nozzle
- 1 reduction nozzle
- 1 reflective nozzle
- 1 scraper

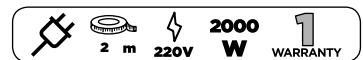
**EG 0541****MINI TORCH WITH RETRACTABLE TUBING + GAS REFILL****Contents:**

EG0540 : 1 x mini torch with retractable tubing
EG0047 : 1 x gas refill



EG 0047 GAS REFILL

Accessory of EG 0050/EG 0540/SA 0540/SA 0541

EG 0540**MINI TORCH WITH RETRACTABLE TUBING****Contents:**

- 1 Mini Gas torch
- assorted colored retractable tubing and sizes:
1x15mmx500mm
60x1.5mm
35x2.5mm
25x3mm
20x5mm
10x6mm
10x10mm

EG0047: gas (not provided)





B.LINE



OE 3008BL

DIGITAL MULTIMETER CAT.I



Specifications:

- DC voltage: 200mV-2000mV-20V-200V-500V
- AC voltage: 200V-500V
- DC current: 200uA-20mA-200mA
- resistance: 200ohm-2000ohm-20Kohm-200Kohm-2000Kohm
- battery: 6LR61 PP3
- dimensions: 126x70x24mm



OE 3004

DIGITAL MULTIMETER CAT. III



Specifications:

- DC voltage: 200mV-2V-20V-200V-300V
- AC voltage: 200mV-2V-20V-200V-300V
- DC current: 20mA-200mA-10A
- AC current: 20mA-200mA-10A
- resistance: 200ohm-2kohm-20kohm-200kohm-2Mohm-20Mohm
- diode test: approx. 2.8V
- temperature: 0-1000°C
- battery test: 1.5-9V-12V
- continuity: <30ohm
- light at the top

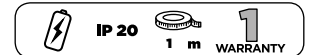

OE 0036

VOLTAGE TESTER WITH SOUND



OE 0065BL

POLARITY/CONTINUITY TESTER 3 TO 48V

B.LINE



AC 5115

UNIVERSAL NON INTRUSIVE TEST PROBE SET CAT. II

Suitable for all standard 4mm instrument sockets.



Contents:

- pair of test leads with straight and 90° connectors max. 1000V, L.120cm
- pair of cable piercers for intrusive measures taking max. 30V
- pair of slim probes for inversed tests max. 24V



OE 3150

DIGITAL VOLTMETER 6-12V

Conversion table of the values (volts) into a charge level (%) integrated in the housing for easy interpretation of the measured values.



Specifications:

- measurement range: 4.5 to 19.99V
- digital display of measured values
- surge protection
- reverse polarity protection
- dimensions: L.120xW.70xH.18mm



OE 5115

CONNECTOR KIT FOR ELECTRICAL MEASURING TOOLS

Allows you to respect manufacturer recommendations as it does not damage the cable harnesses, particularly on multiplexed networks where tapping on the wire is not permitted.

Compatible with instruments diagnostics, multimeters, oscilloscopes



Potentiomètre à résistance variable. 5kΩ.	2		Permet de simuler le signal de sondes et capteurs résistifs de 0 à 5kΩ.
Connecteur à LED.	2		Permet le contrôle de signaux. Indique la polarité par un changement de couleur.
Connecteur SRS.	2		Outils de maintenance pour le remplacement d'airbag.
Pincres crocodiles.	2		Se connectent aux outils de mesure : multimètre, oscilloscope...
Pointes de touche.	2		Se connectent aux rallonges de câbles fournies et aux outils de mesure : multimètre, oscilloscope...
Pointes de touche aciculaire.	4		Ø 0,7 mm - Longueur 30 mm
Connecteur double : permet la connexion en parallèle d'un outil de mesure sur un fil ou une connectique.	2		
Connecteur simple.	4		

Cosses mâles connectable à un outil de mesure.	36		Plates : 0,6 x 0,6 - 3 pièces jaunes 0,6 x 0,9 - 3 pièces rouges 0,6 x 1,3 - 3 pièces noires 0,6 x 1,9 - 3 pièces bleues 0,6 x 2,3 - 3 pièces jaunes 0,8 x 2,8 - 3 pièces rouges 0,8 x 4,7 - 3 pièces noires 0,8 x 6,0 - 3 pièces bleues
			Rondes : 1,6 mm - 3 pièces jaunes 2,3 mm - 3 pièces rouges 3,5 mm - 3 pièces noires 3,9 mm - 3 pièces bleues
Cosses femelles connectable à un outil de mesure.	36		Plates : 0,6 x 0,6 - 3 pièces jaunes 0,6 x 0,9 - 3 pièces rouges 0,6 x 1,3 - 3 pièces noires 0,6 x 1,9 - 3 pièces bleues 0,6 x 2,3 - 3 pièces jaunes 0,8 x 2,8 - 3 pièces rouges 0,8 x 4,7 - 3 pièces noires 0,8 x 6,0 - 3 pièces bleues
			Rondes : 1,6 mm - 3 pièces jaunes 2,3 mm - 3 pièces rouges 3,5 mm - 3 pièces noires 3,9 mm - 3 pièces bleues

NO WARRANTY

OE 5020

AMMETER CLAMP 1000A



- intensity test
- amperemeter test
- diode test
- continuity test
- data-hold function

Technical data:

- IEC 61010 CATII with overload protection
- 3 16mm digit backlit LCD screen
- automatic scales
- comes with battery and test lead
- aperture of the pliers: 55mm
- DC voltage: 600V±(0,5%+5)
- AC voltage: 600V±(1%+5)
- direct current: 200/1000A±(2,5%+5)
- alternating current: 200/1000A±(2,5%+5)
- resistance: 200 ohms±(1,2%+5)
- frequency: 2kHz±(2%+5)
- power supply: 9Vx1

1 m WARRANTY

OE 5116

RETRACTABLE PROBES



NO WARRANTY

AC 5110

OSCILLOSCOPE

This portable oscilloscope is a measuring instrument combining a number of functions to help technicians in their diagnosis of car electrical circuits. It integrates the functions of the oscilloscope and the multimeter.



- For collecting data on:
- voltage
 - signals
 - frequencies
 - OCR (opening cyclic ratio)

Equipped with two measurement input points so two curves can be analyzed simultaneously.
 Example: comparing two sensors at the same time to compare the values of their signals.
 This device is essential for diagnosing electronic management systems and analyzing multiplex signals, commands and data from the different sensors.

Supplied with USB connector cable

- Voltage: peak to peak, average, RMS
- Frequency meter: Frequency/Period
- Resistance: 600ohm-6Kohm-60Kohm-600Kohm/6M-60Mohm
- Diode: =2V
- Mains adapter
- Computer interface
- Software: computer software
- 3,6V lithium battery
- Weight: 700g (with battery)
- Band width: 20MHz
- Number of channels: 2
- Sampling rate: 100MEch/s
- Horizontal sensitivity: 10ns/div
- Horizontal precision: 0.01%
- Horizontal distinction: 10ns
- Vertical sensitivity: 5mV/div-20V/div
- Vertical precision: ± (5% 1 pixel)
- Vertical distinction: 8 bits
- Maximum input voltage: 300V
- Trigger Mode: Normal, Auto, Single
- Screen display: 80mmx60mm
- Back-lighting
- To record: 6 sets of waveforms and 10 sets of parameters
- Input impedance: 1MOhm, =20pF
- Channel isolation: 100:1

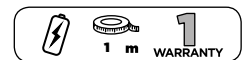

CO 1049

ELECTRIC SPRAY CLEANER 400ml

Cleans and protects electrical connectors.
 Dissolves corrosion.
 Eliminates false contacts, leakage currents and reduces voltage drops.
 Improves productivity.





PROTECTION

OE 0350

HYBRID AND ELECTRIC VEHICLES SECURITY KIT+PPE

Pack of tools, accessories and PPE equipment allowing hybrid and electric vehicles to be secured.



Compatible with authorizations: B1L, B1VL, B1TL, B2L, B2VL, B2TL, BCL, BEL, BRL, B1XL, B2XL.

Contents:

- OE0700: hybrid and electric vehicles insulated tools 1000V
- OE3010: VAT security tester
- OE0302: 1000V insulating gloves (x2)
- OE0303: leather overgloves for insulated gloves
- OE0311: facial protection screen for electrical arcs
- OE0755: insulating sheet 3/10th 12.5x1.3m
- OE0756 (x4): spring clip for insulating sheet



OE 0335

PPE PACK + 1000V VARIOUS TOOLS

Pack of tools, accessories and PPE equipment allowing hybrid and electric vehicles to be secured.

Contents:

- OE0700 : 1 x hybrid and electric vehicles insulated tools 1000v
- OE0302 : 1 x pair of 1000v insulating gloves
- OE0303 : 1 x leather overgloves for insulated gloves
- OE0311 : 1 x facial protection screen for electrical arcs
- OE0755 : 1 x insulating sheet 3/10th 12.5x1.3m
- OE0756 : 4 x spring clip for insulating sheet

Compatible with : B1L, B1VL, B1TL, B2L, B2VL, B2TL, BCL, BEL, BRL, B1XL, B2XL.

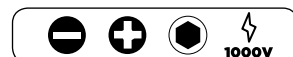

OE 0700**HYBRID AND ELECTRIC VEHICLES INSULATED TOOLS 1000V****Contents:**

- OE0701: socket 7mm insulated 1000V 3/8"
- OE0702: socket 8mm insulated 1000V 3/8"
- OE0703: socket 10mm insulated 1000V 3/8"
- OE0704: socket 12mm insulated 1000V 3/8"
- OE0705: socket 14mm insulated 1000V 3/8"
- OE0706: socket 15mm insulated 1000V 3/8"
- OE0707: socket 17mm insulated 1000V 3/8"
- OE0708: socket 19mm insulated 1000V 3/8"
- OE0709: socket 22mm insulated 1000V 3/8"
- OE0711: insulated ratchet 1000V 3/8"
- OE0712: insulated extension 1000V 3/8"
- OE0713: insulated T-handle 1000V 3/8"
- OE0714: insulated cutter 1000V

Standards: 60900

Compatible with authorizations: B1L, B1VL, B1TL, B2L, B2VL, B2TL, BCL, BEL, BRL, B1XL, B2XL.

- OE0716: 4x100 slotted screwdriver insulated 1000V
- OE0717: 5.5x125 slotted screwdriver insulated 1000V
- OE0718: 1x100 Phillips screwdriver insulated 1000V
- OE0719: 2x100 Phillips screwdriver insulated 1000V
- OE0722: open end wrench 7mm insulated 1000V
- OE0723: open end wrench 8mm insulated 1000V
- OE0724: open end wrench 10mm insulated 1000V
- OE0725: open end wrench 12mm insulated 1000V
- OE0726: open end wrench 14mm insulated 1000V
- OE0727: open end wrench 17mm insulated 1000V
- OE0728: insulated combination pliers 1000V
- OE0729: insulated cutting pliers 1000V
- EVA case

**OE 4002****MULTIMETER MEGOHMETRE AND INSULATION TESTER 1000V CAT. III**

Measures higher voltages and insulation resistances for electrical equipment than classic multimeters. Ideal for hybrid and electrical vehicles.



High voltage,
adapted to hybrid
and electrical vehicles

Specifications:

- DC voltage: 600mV-6V-60V-600V-1000V
- AC voltage: 600mV-6V-60V-600V-750V
- DC current: 60mA-400mA
- AC current: 60mA-400mA
- resistance: 600ohm-6kohm-60kohm-600kohm-6Mohm-60Mohm
- capacitance: 6nF-60nF-600nF-6µF-60µF-600µF-6mF-60mF
- temperature: -30 to 1300°C
- insulation resistance: 50V (5-50Mohm) - 100V (0-100Mohm) - 250V (0-250Mohm) - 500V (0-500Mohm) - 1000V (0-2Gohm)
- calculation of the dielectric reabsorption ratio (DRR) and the automatic polarization index (PI)
- display of min. med. and max. values
- battery: 4 AA 1.5V batteries

Compatible with : B1L, B1VL, B1TL, B2L, B2VL, B2TL, BCL, BEL, BRL, B1XL, B2XL.

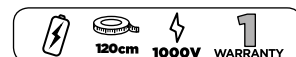
**OE 3010****VOLTAGE SAFETY TESTER**

The voltage safety tester allows to verify the lack of voltage on a electric circuit before an intervention.

Essential equipment for buildings or electrical vehicles (verifying absence of voltage).

It allows voltage on a circuit to be checked in accordance with standards: NF 61010-600V cat3 and IEC 61243-3VAT/DDT.

**Specifications:**

- continuity test
- differential circuit breaker test 30mA
- moisture and dust proof
- voltage test: 2 at 690V AC/DC and 750V DC with noise emission for range change
- auto AC/DC
- resistance measurements until 2kΩ
- continuity noise test until 2kΩ
- frequency of use: DC 50-60Hz and 400Hz
- self-test of probes, cords, displays, 9V battery
- low impedance output: 390kΩ
- probes center distance: 19mm (for circuit breakers)

Compatible with authorizations: B1L, B1VL, B1TL, B2L, B2VL, B2TL, BCL, BEL, BRL, B1XL, B2XL.



OE 0332

PERSONAL ELECTRICAL PROTECTION EQUIPMENT SET



Class 1B8
Colorless

Contents:

- OE0302: 1000V insulating gloves (x2)
- OE0303: leather overgloves for insulated gloves
- OE0311: facial protection screen for electrical arcs

Compatible with authorizations: B1L, B1VL, B1TL, B2L, B2VL, B2TL, BCL, BEL, BRL, B1XL, B2XL.

Specifications:

- liftable anti-scratch screen with ventilated forehead protection
- double-setting ear muffs
- ultraviolet filter
- screen thickness: 1.5mm



Size 10
Standards: EN-388



Size 10



OE 0302	PAIR OF 1000V INSULATING GLOVES
OE 0303	LEATHER OVERGLOVES FOR INSULATED GLOVES
OE 0311	FACIAL PROTECTION SCREEN FOR ELECTRICAL ARCS

OE 0750

CLASS 3 INSULATING MAT - 100x60cm



Specifications:

- max. voltage: 26500V AC
- voltage: 3mm
- dimensions: 100x60cm

Compatible with authorizations: B1L, B1VL, B1TL, B2L, B2VL, B2TL, BCL, BEL, BRL, B1XL, B2XL
Conforms to standard IEC 61111:2009



OE 0305

PNEUMATIC INSPECTION DEVICE TO TEST INSULATING GLOVES

Accessory of OE 0302



Specifications:

- pump: manual
- integrated flexible valve
- 2 elastic "glove holder" rings
- dimensions: 135x135x125mm



OE 0710

4 INSULATION CAPS Ø10mm L.60mm

Specifications:

- capacity: 3 to 10mm²
- Ø max. conductor: 6.5mm
- max. exposed length: 50mm
- semi rigid
- cross-cutting to insert the conductor to be insulated



OE 0715

4 INSULATION CAPS Ø15mm L.100mm

Specifications:

- capacity: 6 to 35mm²
- Ø max. conductor: 11mm
- max. exposed length: 90mm
- semi rigid
- cross-cutting to insert the conductor to be insulated



OE 0721

4 INSULATION CAPS Ø20mm L.120mm

Specifications:

- capacity: 20 to 70mm²
- Ø max. conductor: 15mm
- max. exposed length: 110mm
- semi rigid
- cross-cutting to insert the conductor to be insulated

Allows the exposed extremity of an insulated conductor to be isolated during work/repairs.

Conforms to standard ST BT 430



EG 0012

MARKING/WORK AREA SIGNALING PACK



Back of the banner in English: work zone boundary
Do not cross

Contents:

- EG0013: yellow/black 25m plastic signaling chain
- EG0014-1 (x6): yellow and black signpost Ø40mm
- EG0014-2 (x6): base for signpost
- EG0015: signage banner "work zone boundary" 100x20cm

Compatible with authorizations: B1L, B1VL, B1TL, B2L, B2VL, B2TL, BCL, BEL, BRL, B1XL, B2XL.



EG 0013

PLASTIC SIGNALING CHAIN
YELLOW/BLACK 25m

Accessory of EG 0014

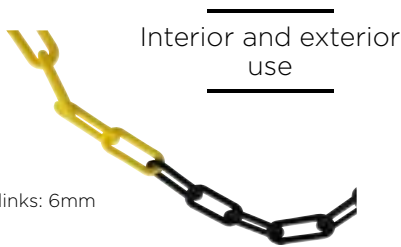

Quick and easy installation on the signaling post (EG0014).

Compatible with: B1L, B1VL, B1TL, B2L, B2VL, B2TL, BCL, BEL, BRL, B1XL, B2XL.

Allows a work zone or a dangerous area to be delimited...



EG 0014N

YELLOW AND BLACK
SIGNPOST Ø40mm

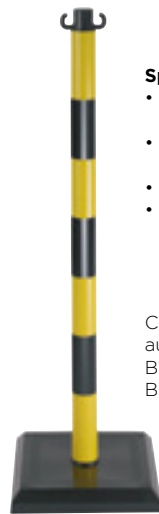

Specifications:

- 2 rings with chain/strap connection
- post material: black and yellow solution-dyed plastic
- base material: solid rubber
- height: 90cm

Compatible with authorizations: B1L, B1VL, B1TL, B2L, B2VL, B2TL, BCL, BEL, BRL, B1XL, B2XL.



EG 1050

ADHESIVE SIGNALING AND
SAFETY VINYL TAPE 33m
W.50mm

With yellow and black hatched markings, allows security equipment or evacuation routes to be marked out, draws attention to steps on a staircase, allows areas or dangerous substances to be signaled, etc.



Specifications:

- width: 50mm
- thickness: 0.129mm
- adhesion to steel: 210cN/cm
- load at rupture: 2.3daN/cm
- elongation at rupture: 180%



OE 0756

SPRING CLIP FOR INSULATING
SHEET

Accessory of OE 0755

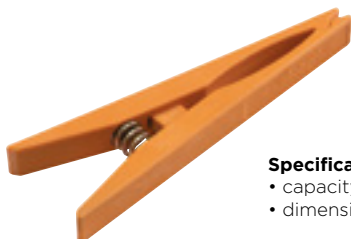

Specifications:

- capacity: 25mm
- dimensions: 165x18mm

Compatible with authorizations: B1L, B1VL, B1TL, B2L, B2VL, B2TL, BCL, BEL, BRL, B1XL, B2XL.

EG 0015

SIGNAGE BANNER "WORK ZONE BOUNDARY"
100x20cm



Specifications:

- 4 eyelets + 2 fixing cords
- coated fabric
- dimensions: 100x20cm

Back of the banner in English:
Work zone boundary
Do not cross



EG 0017

PIT PROTECTION COVER REEL 20m



To signal and define a pit or a dangerous area.
Reduces the risk of accidents.

- equipped with a hook to facilitate the delimitation
- anti-UV band
- band width: 40mm
- 180° wall support
- stop device every 50cm



OE 0720

INSULATING RESCUE ROD L.147cm

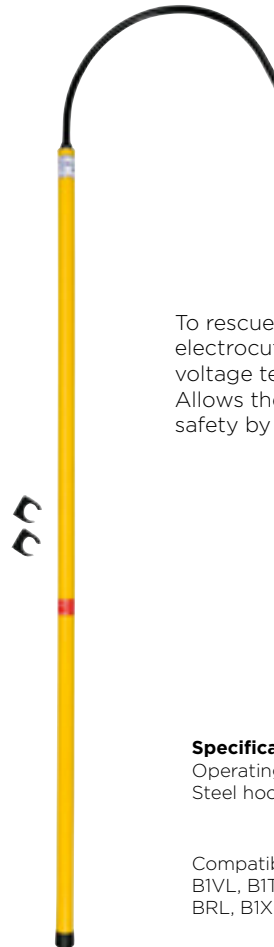

To rescue an operator affected by electrocution, glare... when repairing a voltage tester for example.
Allows the injured party to be brought to safety by pulling them by the waist.

Specifications:

Operating voltage: 45,000V
Steel hook 18x1.5mm

Compatible with authorizations: B1L, B1VL, B1TL, B2L, B2VL, B2TL, BCL, BEL, BRL, B1XL, B2XL.

Supplied with wall hooks.



OE 0755

INSULATING SHEET 3/10th 12.5x1.3m



Allows temporary insulation in order to install parts and conductors which are exposed or insufficiently insulated.

Specifications:

- max. voltage: 1000V AC
- material: Insulating, fireproof PVC
- thickness: 3/10th
- dimensions: 12.5x1.3m

Compatible with authorizations: B1L, B1VL, B1TL, B2L, B2VL, B2TL, BCL, BEL, BRL, B1XL, B2XL.
Conforms to standards ST TST BT 420 and IEC 61112 category 0 (1000V).



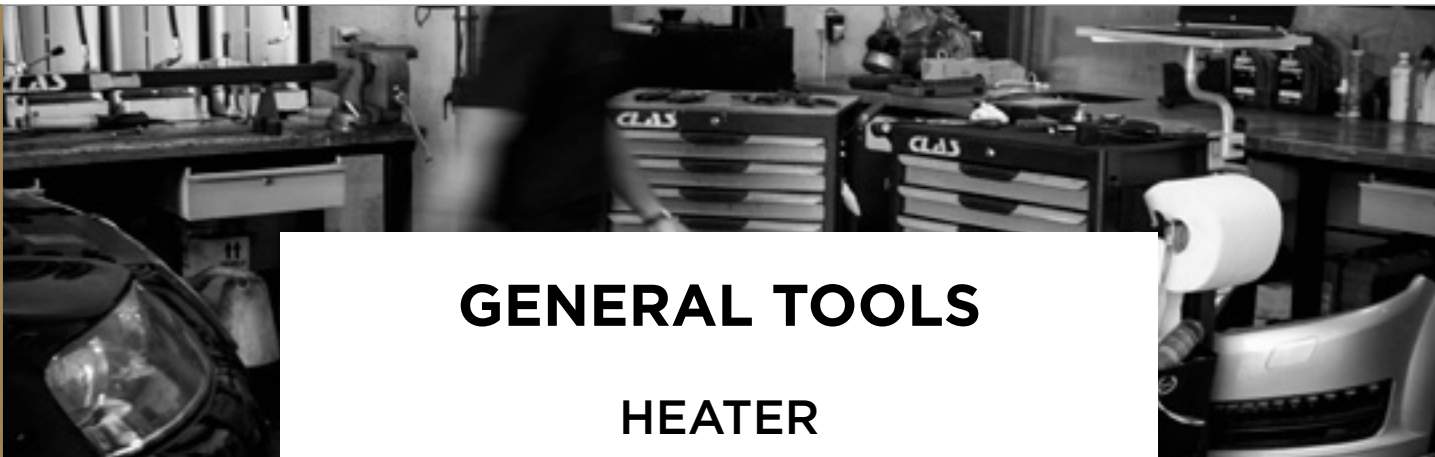

GENERAL TOOLS

HEATER

5100611.3

INFARED HEATER V40

NEW



- Metal and tubular structure painted with epoxy powders
- Direct heat flow without air moving
- Odourless combustion
- Ceramic-fibre combustion chamber
- Electronic flame check with photo-resistance
- Post-ventilation device for combustion chamber cooling
- Possibility to use an ambience thermostat
- Thermoplastic tank
- Vertically adjustable dish.
- Fuel: kerosene/diesel oil

Fuel pressure 2 bar/psi

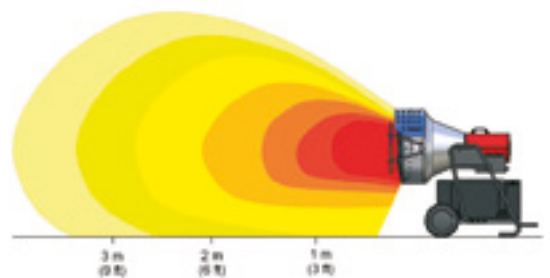

CAPACITY	kW	Heating capacity	Power consumption	Fuel consumption
55 L	42	36173 Kcal/h	100W	3.53 kg/h

100 W
230V
WARRANTY

DIRECT DIESEL OIL HEATER + EXCHANGER ANTARES

NEW

DIRECT DIESEL OIL HEATER +
EXCHANGER ANTARES 20DIRECT DIESEL OIL HEATER +
EXCHANGER ANTARES 50DIRECT DIESEL OIL HEATER +
EXCHANGER ANTARES 70

Metal structure painted with epoxy powders
 Stainless steel fully proof combustion chamber
 Electronic flame check with photo-resistance and equipment
 Safety thermostat for excess temperature
 Post-ventilation device for combustion chamber cooling
 Efficiency up to 90%
 Pre-set for ambient thermostat
 Suitable for max. 12 meters ducting with
 standard conveyor and spiral pipe kit
 Suitable for closed environments
 Combustion head with clean air suctioning from outside and
 separated ventilation (only for mod. Antares 100)

REF	DESIGNATION	CAPACITY	kW	Heating capacity (Kcal/h)	Air flow rate	Power consumption	Fuel consumption (kg/h)
5100240.4	DIRECT DIESEL OIL HEATER + EXCHANGER ANTARES 20	35 L	20	17.200	1250m ³ /h	200W	1.69
5100298.5	DIRECT DIESEL OIL HEATER + EXCHANGER ANTARES 25	35 L	25	21.500	1250m ³ /h	200W	2.14
5100174.3	DIRECT DIESEL OIL HEATER + EXCHANGER ANTARES 30	70 L	32	27.520	1900m ³ /h	300W	2.5
5100167.3	DIRECT DIESEL OIL HEATER + EXCHANGER ANTARES 50	70 L	48,5	41.280	1900m ³ /h	300W	4.0
5100168.3	DIRECT DIESEL OIL HEATER + EXCHANGER ANTARES 70	120 L	71,3	61.318	3500m ³ /h	750W	6.0
5100221.3	DIRECT DIESEL OIL HEATER + EXCHANGER ANTARES 80	120 L	80,6	69.316	3900m ³ /h	750W	6.8



DIRECT DIESEL OIL HANGING HEATER + EXCHANGER ANTARES



NEW

- Metal structure painted with epoxy powders
- Stainless steel fully proof combustion chamber
- Electronic flame check with photo-resistance and equipment
- Safety thermostat for excess temperature
- Post-ventilation device for combustion chamber cooling
- Efficiency up to 90%
- Pre-set for ambient thermostat
- Suitable for max. 12 meters ducting with standard conveyor and spiral pipe kit
- Suitable for closed environments
- Hanging models for fixed use

REF	DESIGNATION	kW	Heating capacity (Kcal/h)	Air flow rate	Power consumption	Fuel consumption (kg/h)
5100180.3	DIRECT DIESEL OIL HANGING HEATER + EXCHANGER ANTARES 50	48,5	41.280	1900m ³ /h	300W	4.0
5100182.3	DIRECT DIESEL OIL HANGING HEATER + EXCHANGER ANTARES 70	71,3	61.318	3500m ³ /h	750W	6.0
5100379.3	DIRECT DIESEL OIL HANGING HEATER + EXCHANGER ANTARES 80	80,6	69.318	3900m ³ /h	750W	6.8



DIRECT DIESEL OIL HEATER MIZAR PX

NEW



DIRECT DIESEL OIL HEATER MIZAR PX 20



DIRECT DIESEL OIL HEATER MIZAR PX 50

- Metal structure painted with epoxy powders
- Stainless steel fire box
- Electronic flame check with photo-resistance
- Post-ventilation device for combustion chamber cooling
- Safety thermostat for excess temperature
- Model 15 portable
- Models 20-30-40-50 trolley-mounted
- Suitable for open or semi-open environments
- Pre-set for ambient thermostat
- Diesel oil gear pump

REF	DESIGNATION	CAPACITY	KW	Heating capacity (Kcal/h)	Air flow rate	Power consumption	Fuel consumption (kg/h)
5100510	DIRECT DIESEL OIL HEATER MIZAR PX 15	20 L	16,5	14.280	500m ³ /h	150W	1.40
5100512	DIRECT DIESEL OIL HEATER MIZAR PX 20	20 L	20	17.200	500m ³ /h	150W	1.65
51004321	DIRECT DIESEL OIL HEATER MIZAR PX 30	35 L	30	25.800	1750m ³ /h	150W	2.53
5100434.2	DIRECT DIESEL OIL HEATER MIZAR PX 40	35 L	40	34.400	1750m ³ /h	150W	3.37
5100436.2	DIRECT DIESEL OIL HEATER MIZAR PX 50	35 L	50	43.000	1750m ³ /h	200W	4.22



DIRECT DIESEL OIL HEATER MIZAR P



NEW

DIRECT DIESEL OIL HEATER MIZAR P 60

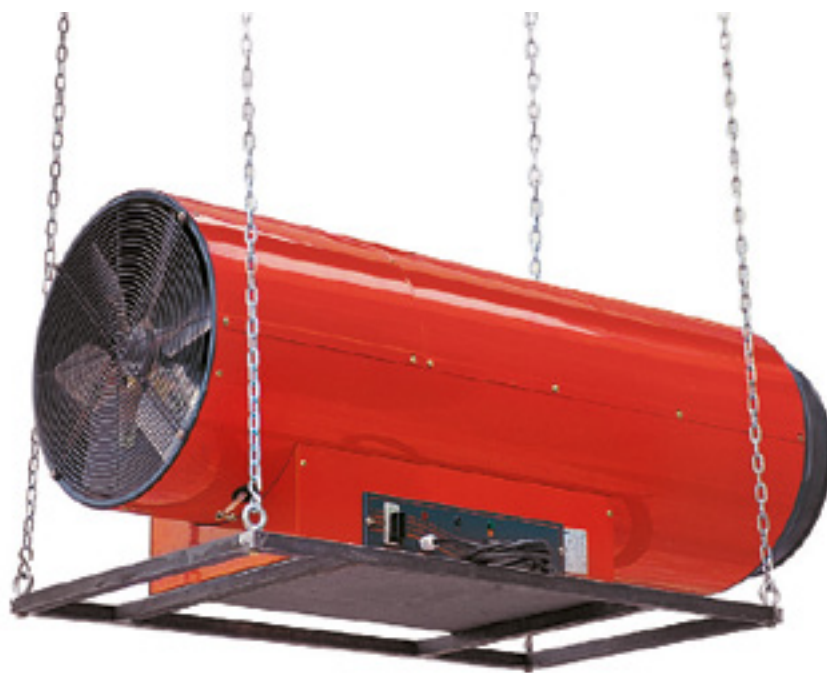

DIRECT DIESEL OIL HEATER MIZAR P 60 HANGING

Metal structure painted with epoxy powders
 Stainless steel fire box
 Electronic flame check with photo-resistance
 Post-ventilation device for combustion chamber cooling
 Safety thermostat for excess temperature
 Suitable for open or semi-open environments
 Pre-set for ambient thermostat
 Models 60-80-105 available also hanging

REF	DESIGNATION	CAPACITY	kW	Heating capacity (Kcal/h)	Air flow rate	Power consumption	Fuel consumption (kg/h)
5100238.2	DIRECT DIESEL OIL HEATER MIZAR P 60	70 L	60	51.600	1900m ³ /h	300W	5.06
5100262.2	DIRECT DIESEL OIL HEATER MIZAR P 60 HANGING	-	-	-	-	-	-
5100239.2	DIRECT DIESEL OIL HEATER MIZAR P 80	120 L	80	68.800	3500m ³ /h	150W	6.75
5100263.2	DIRECT DIESEL OIL HEATER MIZAR P 80 HANGING	-	-	-	-	-	-
5100173.2	DIRECT DIESEL OIL HEATER MIZAR P 105	120 L	105	90.300	3500m ³ /h	150W	8.80
5100179.2	DIRECT DIESEL OIL HEATER MIZAR P 105 HANGING	-	-	-	-	-	-



GAS HEATER K2 CG 850

NEW



- Metal structure painted with epoxy powders
- Piezoelectric ignition (M)
- Safety device using thermocouple and thermostat (M)
- Electronic check device (E)
- Flame safety check
- Motor with thermal protection
- Power delivery control
- Suitable for open or semi-open environments

Gas type G 30-31 Propane Butane



Accessories: see website.



REF	DESIGNATION	kW	Heating capacity (Kcal/h)	Air flow rate	Power consumption	Fuel consumption (kg/h)
6001210	GAS HEATER K2 CG 850 M	52,8-97,5	45.410 82.850	3250m ³ /h	150W	3,77 7,15
6000800.1	GAS HEATER K2 CG 850 E	52,8-97,5	45.410 82.850	3250m ³ /h	150W	3,77 7,15

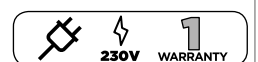

ELECTRONIC GAS HEATER K2 CG-E

NEW



Gas type G 30-31 Propane Butane

- Metal structure painted with epoxy powders
- Burner in stainless steel
- Flame safety is checked using an electronic device
- Motor with thermal protection
- Power delivery control
- Suitable for open or semi-open environments

REF	DESIGNATION	kW	Heating capacity (Kcal/h)	Air flow rate	Power consumption	Fuel consumption (kg/h)
6001180	ELECTRONIC GAS HEATER K2 CG-E 300	23,4-37,3	20.081 32.078	1000m ³ /h	80W	1.81 2.90
6001190	ELECTRONIC GAS HEATER K2 CG-E 400	30,7-46,5	26.400 40.000	1600m ³ /h	103W	2.37
6001202	ELECTRONIC GAS HEATER K2 CG-E 600	46-69	40.000 60.000	3270m ³ /h	188w	3.55 5.40



MANUAL GAS HEATER K2 CG-M

NEW



Gas type G 30-31 Propane Butane

- Metal structure painted with epoxy powders
- Burner in stainless steel
- Flame safety is checked using a thermostat thermocouple and solenoid valve
- Piezoelectric ignition
- Power delivery control
- Motor with thermal protection
- Suitable for open or semi-open environments

REF	DESIGNATION	kW	Heating capacity (Kcal/h)	Air flow rate	Power consumption	Fuel consumption (kg/h)
60011731	MANUAL GAS HEATER K2 CG-M 300	23,4-37,3	20.081 32.078	1000m ³ /h	80W	1.81 2.90
60011831	MANUAL GAS HEATER K2 CG-M 400	30,7-46,5	26.400 40.000	1600m ³ /h	103W	2.37
60011951	MANUAL GAS HEATER K2 CG-M 600	46-69	40.000 60.000	3270m ³ /h	188w	3.55 5.40



GAS HEATER KAFER



NEW

Metal structure painted with epoxy powders
 Burner in stainless steel
 Control box in thermoplastic material with degree of insulation IP 44
 Flame safety is checked using a thermostat thermocouple and solenoid valve
 Piezoelectric ignition
 Motor with thermal protection
 Suitable for open or semi
 Open environments

Gas type G 30-31 Propane Butane



Accessories: see website.

REF	DESIGNATION	kW	Heating capacity (Kcal/h)	Air flow rate	Power consumption	Fuel consumption (kg/h)
60011071	GAS HEATER KAFER 75 F	12	10.320	350m ³ /h	29W	0.94
60011241	GAS HEATER KAFER 100 R	6-15	5.160 12.900	350m ³ /h	29W	0.44 1.09
6001132	GAS HEATER KAFER 180 R	16-30	13.760 25.800	650m ³ /h	80W	1.12 2.10

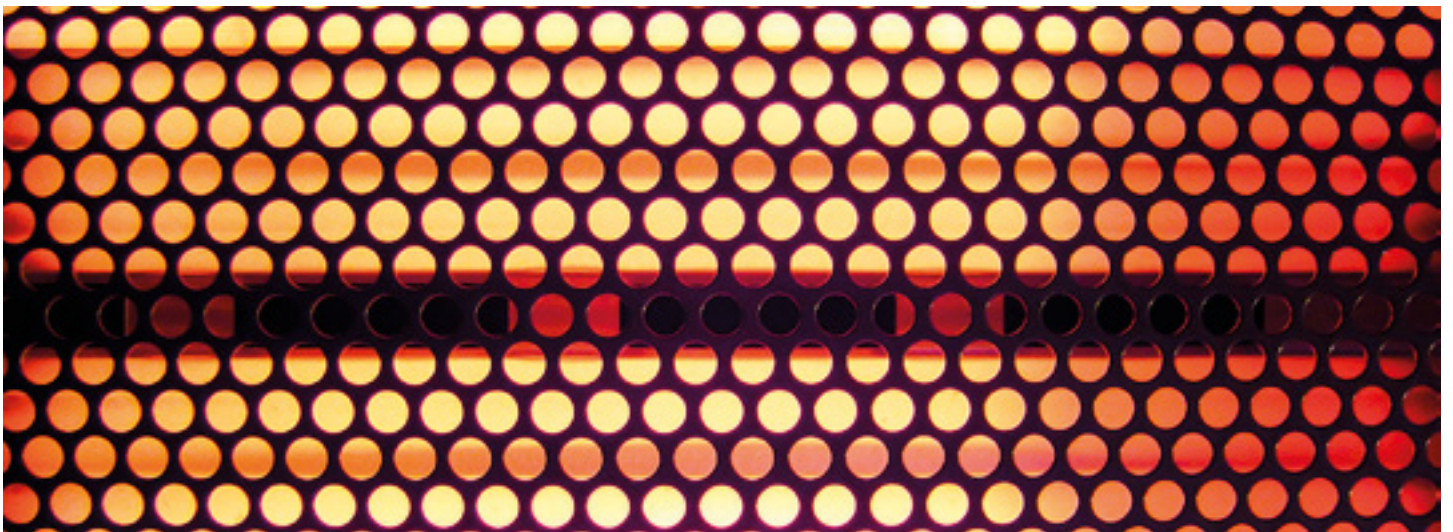

ELECTRICAL HEATER SUNBEAM



- Metal structure painted with epoxy powders
- Selector switch to permit the use of the machine at two heating levels and with the possibility to use the fan only
- Ambient thermostat for temperature setting
- Safety thermostat for machine protection
- Armoured element Inox
- Motor with thermal protection
- Cable and plug included on all models

Delta-t 37°C
Absorption 13 Amp.

REF	DESIGNATION	kW	Tension	Heating capacity (Kcal/h)	Air flow rate	Power consumption
7700025	ELECTRICAL HEATER SUNBEAM 30	2-3	230V/50Hz	1.720 2.580	300m³/h	13 Amp.
7700083	ELECTRICAL HEATER SUNBEAM 90	6-9	400V/50Hz	5.160 7.740	650m³/h	13 Amp.
7700023	ELECTRICAL HEATER SUNBEAM 150	9-15	400V/50Hz	8.600 12.900	950m³/h	22,5 Amp.
7700024	ELECTRICAL HEATER SUNBEAM 180	9-18	400V/50Hz	10.320 15.480	1500m³/h	22,5 Amp.



MORE

How to choose your heater

1. DETERMINE THE VOLUME

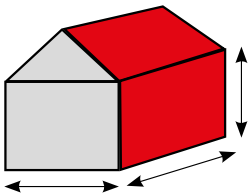

VOLUME = HEIGHT X LENGHT X WIDTH

V = m³

write inside the box your volume

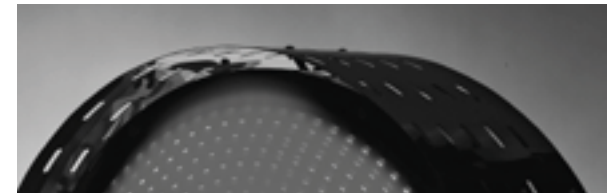

2. DETERMINE THE DEVIATION BETWEEN THE DESIDERED TEMPERATURE AND MINIMUM OUTSIDE TEMPERATURE

T = °C

write inside the box the temperature gap you measured

Ex : desired temperature 15° C, minimum outside temperature -10° C deviation 25° C.



3. WHAT IS YOUR ROOM NATURE?

You really should take into consideration the degree of insulation of your building, to this degree corresponds a coefficient "K", which you will be able to estimate having a look at the following table:

- K = 1,2 = very well insulated building, brick insulated walls with insulated roof.
- K = 2,4 = medium insulated building, brick walls with insulated roof.
- K = 3,5 = badly insulated building, brick walls with non-insulated roof.
- K = 4 = non-insulated building, corrugated iron or wooden walls, same material roof.

K =

write inside the box your "K" factor

DETERMINATION OF THE POWER NEEDED

V x ΔT x K = kcal/h

Examples of data to choose the appropriate heating system

Débit calorifique Thermal power	Pression Pressure	Superficie Surface	Temperature Temperature	Dimensions Dimensions	Débit d'air Flow rate	Capacité Capacity	Puissance Power	Poids Weight
1 kW = 860,61 kcal/h	1 bar = 14,504 PSI	1 mq = 1550,03 Inches²	°F = 9/5 x °C + 32	1 mm = 0,03937 Inches	1 l/h = 0,2641 Gallon/h	1 L = 0,2641 Gallon	1 HP = 0,75 Kw	1 kg = 35,274 Ounces
1 kW = 3415,18 BTU/h	1 bar = 10 ⁵ Pa	1 mq = 10,764 Feet²	°K = °C + 273,15	1 mm = 0,00328 Inches	1 l/h = 0,22 Gallon(UK)/h	1 L = 0,22 Gal-lon (UK)	1 CV = 1,01387 HP	1 kg = 2,205 Pounds



WORKSHOP FURNITURE



EG 0357

PERFORATED PANEL TOOL RACK 500x900x30mm

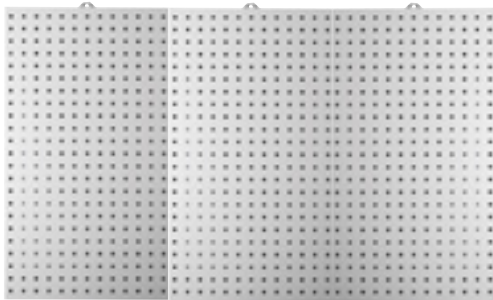

Modular to meet your needs, EG0357 panels have been designed to be assembled together.



Perforation, square 10x10, clearance 38mm



EG 0344

BAG OF 10 DOUBLE HOOKS Ø6mm L.50mm



EG 0346

BAG OF 10 SIMPLE HOOKS Ø6mm L.50mm



EG 0347

BAG OF 10 DOUBLE HOOKS Ø6mm L.100mm



Ø hook: 6mm
Tip 45°
Squared perforated panel fixing 10x10mm (38mm gap)



EG 0340

1500x175mm SHELF

Accessory of EG 0357/EG 0338/EG 0348

EG 0341

2000x175mm SHELF

Accessory of OM 3000/HU 3000/EG 0357/EG 0339/EG 0349



95kg

EG 0335

1.5m METAL WORKBENCH WOODEN TRAY

Dimensions:
• wooden trays: L.1500xI.750xH.30mm
• framework: L.1410xI.692xH.855mm
• storage (metal plate): L.1410xI.610mm



120kg

EG 0336

2m METAL WORKBENCH WOODEN TRAY

Dimensions:
• wooden trays: L.2000xI.740xH.30mm
• framework: L.1900xI.692xH.855mm
• storage (metal plate): L.1900xI.610mm

EG 0337 DRAWER Accessory of EG 0335/EG 0336



EG 0083

3 TRAY ROLLER CABINET



Tray rollers
p. 96

Specifications:

- overall dimensions: 766x415x840mm
- tray dimensions: 760x410x60mm
- 2 fixed casters Ø100mm
- 2 swiveling casters Ø100mm with brakes
- 2.5mm thick EVA foam tray protection
- admissible load per shelf: 90kg
- total admissible load: 270kg



OH 1300

500kg HYDRAULIC LIFT TABLE

Ideal for handling parts (boxes, engines, axles...)



Specifications:

- pedal hydraulic lift command
- dead man-type descent command
- tray dimensions 1010x520mm
- 2 fixed wheels and 2 swiveling wheels with protective casing and brakes
- h. min.: 440mm
- h. max.: 1575mm

OC 0711

BODYWORK 3 TRAY STORAGE TROLLEY



Allows parts which have been uninstalled to be put away and stored such as headlights, headrests, instrument panels, bumpers...etc

Specifications:

- 3 trays (2 wooden and 1 mesh)
- platform height: 260-810-1390mm
- mesh base
- 4 swiveling wheels, 2 of which have brakes
- dimensions: L.630xW.1110xH.1625mm



EQUIPMENT

EG 0225

900W INDUSTRIAL BENCH GRINDER
Ø200x32x32mm WHEEL+BRUSH



Supplied with:

- brush Ø200mm
- grinding wheel grit 60

Specifications:

- adjustable protective screen with magnifying lens
- dual extractor vent
- speed: 2950 rpm

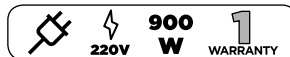
**EG 0273**

VITRIFIED GRINDING
WHEEL GREY CORUNDUM
200x32x32mm GRIT 60

Accessory of EG 0225/EG 0220

**EG 0221**

BENCH GRINDER BRUSH

Accessory of EG 0225/EG 0220



External Ø200mm
Inner Ø13 to 32mm, adjustable
using plastic rings (included)

**OM 4066**

PARALLEL JAW CLAMPS 150mm QUICK
TUBE HOSE APPROACH

Specifications:

- jaw width: 150mm
- jaw height: 20mm
- opening: 180mm
- interchangeable steel jaws
- supplied with revolving base with 3 anchoring points

Releasable jaw system allowing
you to make adjustments to the
jaw immediately.



EG 7050	2 JAW 150mm SET	Spare part of OM 4066
EG 7051	2 JAW 200mm SET	Spare part of OM 4068
EG 7053	150mm 2 RUBBER COATING MAGNETIC JAW SET	Spare part of OM 4066
EG 7054	200mm 2 RUBBER COATING MAGNETIC JAW SET	Spare part of OM 4068

OM 4068

PARALLEL JAW CLAMPS 205mm QUICK TUBE
HOSE APPROACH

Specifications:

- jaw width: 205mm
- jaw height: 22mm
- interchangeable steel jaws
- tube, anvil and horn jaws
- jaw opening: 260mm
- supplied with revolving base with 3 anchoring points (180x225mm)

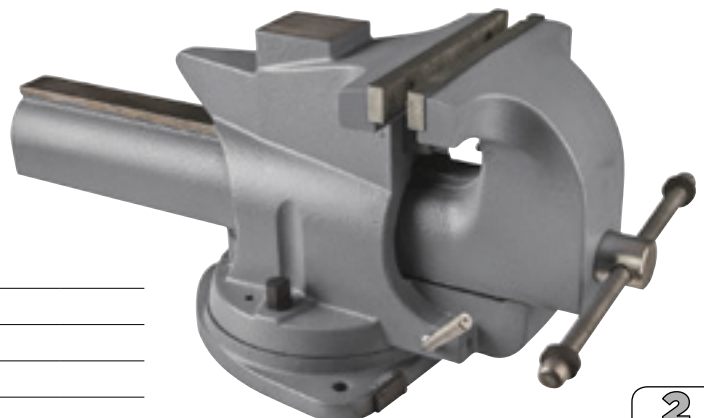

EG 0106

6-WHEEL BUCKET-SEAT INSPECTION CREEPER



Specifications:

- supplied with 2 tool racks
- carrying handle
- hydrocarbon-proof material
- dimensions: 100x48x11cm
- wheel Ø: 60mm
- high-pressure washable



SA 3205 PIVOTING WHEEL Ø77x20mm



EG 0109

INSPECTION CREEPER 150Kg

NEW



Specifications:

- equipped with 2 tool holders
- carrying handle
- hydrocarbon-resistant material
- dimensions: 100x47x13cm
- Wheel Ø: 75mm
- high pressure washable
- reinforced wheel support



EG 0108

MULTIFUNCTIONAL FOLDING WORKSHOP TROLLEY 150kg

Folding backrest for convenient storage



Specifications:

- capacity: 150kg
- non-slip covering
- rubber shock-proof edges
- 4 Ø120mm wheels, 2 of which swivel for improved handling
- dimensions: L.870xW.575xH.900mm
- folded height: 290mm
- platform height: 195mm

SA 0108 FIXED WHEEL Ø120mm

SA 0109 PIVOTING WHEEL Ø120mm



OM 0099

TOOL-STORAGE STOOL



Specifications:

- height-adjustable
- 2 levels of tool storage
- allows you to work on all low parts
- h. min.: 400mm
- h. max.: 510mm



DRILLING

EG 0681

170PCS DRILL SET HSS COBALT 5%

NEW



Contents:

- 10 drills from 1 to 8mm, every 0.5mm
- 5 drills from 8.5 to 10mm, every 0.5mm

Material: Cobalt HSS 5%

NO WARRANTY

EG 0671BL

170PCS DRILL SET HSS4241

B.LINE



NEW



Contents:

- 10 drills from 1 to 8mm, every 0.5mm
- 5 drills from 8.5 to 10mm, every 0.5mm

NO WARRANTY



EG 0680

25PCS DRILL SET HSS COBALT 5%

NEW



Contents:
Drills from 1.0 to 13.0mm, every 0.5mm
Material: Cobalt HSS 5%

NO
WARRANTY

EG 0670BL

25PCS DRILL SET HSS4241

NEW

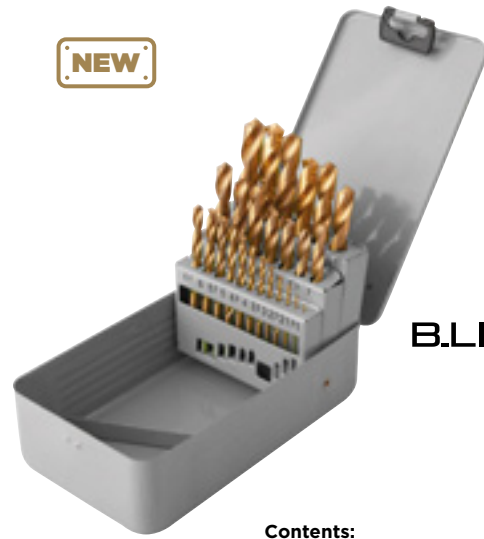

B.LINE



Contents:
Drills from 1.0 to 13.0mm, every 0.5mm

NO
WARRANTY



OM 0653

SCREW EXTRACTOR SET + HSS DRILLS
Ø2-Ø7.5mm

Allows the center of broken screws to be pierced and then extracted using a pig tail extractor. The pig tail extractors can be used with a tap holder with ratchet (OM9325) depending on the size or with a tap wrench.

Contents:
• 5 pig tail extractors no.1-2-3-4-5
• 5 HSS drill bits Ø2-3-4-6.5-7.5

NO
WARRANTY

OM 0643

10mm 5 CARBIDE ROTARY RASPS BOX



Specifications:
• right cut
• diamond gearing
• 6mm cylindrical shank
• material: carbide

NO
WARRANTY

EG 0432

4-32mm HSS STEP DRILL



Stepping: 2mm

NO
WARRANTY

HU 0511

OIL CAN 500ml



500
ml **2**
WARRANTY



OM 9221

37 PCS DRILL-TAPS-DIES SET

Contents:

- 8 dies : 3x0.5-3.5x0.6-4x0.7-5x0.8-6x1.0-8x1.25-10x1.50-12x1.75
- 8 taper taps
- 8 bottoming taps in sizes shown
- 8 HSS drills 2.5/2.9/3.3/4.2/5/6.8/8.5/10.3mm
- + accessories



SA 9221 TAP HOLDERS M4-M12 / 3/16"-1/23"

Spare part of OM 9221/OM 9222/OM 9223



OM 9222

52 PCS TAP & DIE SET

Contents:

- 7 dies: M3x0.5/M4x0.7/M5x0.8/M6x1.0/M8x1.25/M10x1.50/M12x1.75
- 5 UNF dies 1/4", 5/16", 3/8", 1/2"
- 2 BSP dies 1/8", 1/4"
- 14 taps sizes as indicated
- 13 HSS drills: 2.5-3.3-4.2-5-5.5-6.8-6.9-8.5-8.8-9.9-10.3-11.4-11.8mm
- 5 pigtail extractor N°1-2-3-4-5
- + accessories



OM 9223

75 PCS TAP & DIE SET

Contents:

- 18 dies: M2x0.25-M3x0.35-M3x0.5-M3.5x0.6-M4x0.5-M4x0.7-M4.5x0.75-M5x0.5-M5x0.8-M6x0.75-M6x1.0-M8x1.0-m8x1.25-M10x1.25-M10x1.5-M12x1.25-M12x1.75-BSP28 1/8"
- 18 taps coarse shank, dimensions see dies
- 18 taps fine shank, dimensions see dies
- 17 HSS drill bits: 1.7-2.5-2.6-2.9-3.3-3.5-3.8-4.2-4.5-5-5.3-6.8-7-8.5-8.8-10.3-10.7mm
- + accessories



OM 9300

METRICAL INNER/OUTER THREAD FILE 0.8-3.0

Allows the inner or outer thread to be measured in order to reform them by passing over the affected area.

Each side of thread has a different notch as follows:
0.80-1.00-1.25-1.50-1.75-2.00-3.00
Length: 230mm



OM 9325

TAP HOLDERS AND RATCHET THREADERS BOX



Contents:

- 1 ratchet 3/8"
- 2 die-holders Øext: 9 to 25mm
- 2 tap holders M3 to M12



OM 0450

M5-M12 INSERT SET

For repairing worn or damaged threading.
 Inserts in stainless steel, highly resistant to breaking, corrosion and temperature.
 Box made up of inserts from M5 to M12, helical drills, taps, assembly tools and tang breakers.



Contents:

- helical drills
- taps
- assembly tools
- tang breakers
- 12 inserts M5x0.8 (OM0452: 25 inserts)
- 12 inserts M6x1 (OM0453: 25 inserts)
- 12 inserts M8x1.25 (OM0454: 25 inserts)
- 12 inserts M10x1.50 (OM0455: 25 inserts)
- 12 inserts M12x1.75 (OM0456: 10 inserts)

Stainless steel inserts
 Length of assembled thread insert: 6.7mm



OM 0452	25 PCS M5x0.8 INSERT SET
OM 0453	25 PCS M6x1 INSERT SET
OM 0454	25 PCS M8x1.25 INSERT SET
OM 0455	25 PCS M10x1.50 INSERT SET
OM 0456	10 PCS M12x1.75 INSERT SET



OM 0457

10 PCS M14x125 INSERT SET

Stainless steel inserts.
 Special spark plug thread.



OM 0458

10 PCS M14x2.0 INSERT SET

Spare part of OM 0459

Stainless steel inserts



OM 0486	M5x0.8 INSERT SET	Contents: • drill Ø5.2mm • tap M5x0.8 • running tool insert • 25 stainless steel inserts
OM 0487	M6x1.0 INSERTS SET	Contents: • drill Ø6.3mm • tap M6x1.0 • running tool insert • 25 stainless steel inserts
OM 0488	M8x1.25 INSERT SET	Contents: • drill Ø8.3mm • tap M8x1.25 • running tool insert • 25 stainless steel inserts
OM 0489	M10x1.50 INSERT SET	Contents: • drill Ø10.4mm • tap M10x1.5 • running tool insert • 25 stainless steel inserts
OM 0490	M12x1.75 INSERT SET	Contents: • drill Ø12.4mm • tap M12x1.75 • running tool insert • 25 stainless steel inserts
OM 0459	M14x2.0 INSERT SET	Drill M14.5 Tap M14x2.0 Running tool insert 12 stainless steel inserts Length reported net mounted 20mmx4-15mmx4-10mmx4



CO 1027

**EXPRESS PAINT REMOVER
SPRAY 500ml**



Applications: Acrylic, Glycerol, Alkyd, Pliolite...
Allows paint, varnish and ink pickling on every body repair painted element.
Remove burned and imbedded seals (cylinder head, gearbox, water pump, etc).

It allows you to achieve excellent results with no effort required.
Its active formula breaks down problems quickly.
This product is suitable for use on solvent-resistant mounts.



CO 1029

**BODY REPAIR DEGREASING/CLEANING
SPRAY 500ml**



**Degreases
and eliminates
silicone anti-static**

Allows you to degrease and clean bodywork parts before painting or adhesion.
Eliminates residues of glue, grease, oil, silicone.



CO 1026

**SUPER RELEASING GRAPHITE
SPRAY 400ml**



Thanks to its very low surface tension graphite formula, this super releasing spray penetrates deeply to erode rust, leaving a protective graphite film. Facilitates future removal.

Releases and protects, minimizes friction and stops rust.



CO 1035

NO RUST SPRAY 400ml



If the surface does not require sanding and the rust is superficial, the rust prevention spray will let you "stabilize" the rust in order to stop it from spreading.
You can then have the surface painted as it is. If your surface has not yet been attacked by rust, you can use this spray as a preventative measure in order to protect it.

Stops rust developing on bodywork and running gears.
For preventative and curative use.





CO 1030

LUBRICANT SILICONE
UNIVERSAL SPRAY 500ml



Anti corrosion, anti
oxidation

The funnel is held firmly in place on the bottle to be filled with its automatically adjustable clamp, which limits the risk of spilling liquid.



CO 1031

LUBRICANT TEFLON SPRAY 500ml



Without residues
of fat and silicone:
dust does not
stick.

Allows parts to be lubricated which cannot be greased in order to avoid dust sticking to them. Also allows for the maintenance of rubber and plastics.

Effective between -50 and +250°C.



CO 1023

MULTI-FUNCTIONAL GLUE SPRAY 400ml



Allows headliners, trims, rods, engine foams, upholstery, vinyl, carpet to be glued...

High-adhesion spray for a wide range of uses with high initial resistance. The glue's adhesion properties develop quickly and it is extremely water resistant and long-lasting.

With no filament, it
remains flexible after
drying





CO 1046

MASTIC BAR TO MODEL METAL REPAIR 57g

Allows repairing broken metal, sealing a radiator, recreating fixing brackets, rethreading on all types of metals...

NEW

Specifications :

- thermal resistance: 150°C
- water and hydrocarbon resistant
- drying time: 10min to the touch, 3h to the core

Wait 1 hour before drilling, tapping, sanding, painting...

NO WARRANTY

CO 1024

BLACK STRUCTURAL GLUE 50ml

Accessory of OC 1024

Specially for plastic, this glue is perfectly suited for quick adhesion to plastic, metal, glass, wood, stone...
Allows you to create material to repair window screens, rods, headlight brackets, rear-view mirror brackets.
Can be sanded, ground, drilled, tapped and painted.

Ideal for plastic repair



Specifications:

- time required for structuring: 1min
- time required for drying: 5min
- 2K polyurethane glue

CO 1054 STRUCTURAL GLUE MIXING NOZZLE

NO WARRANTY

CO 1022

GLUE AND WHITE MASTIC CARTRIDGE 310ml

Permits adhesion of spoilers, vehicle undersides, flat crimping, application of mastic to pointed steel plates...etc
Can be painted straight after application.

Adheres to steel, aluminum, stainless steel, wood, concrete, stone, gelcoat, polyester, glass, lacquers and treated paint.

NEW

Adhesion without primer on metallic surfaces



Latest generation MS polymer adhesive cartridge allows you to achieve all types of seals and adhesion with no mechanical assembly required.
Easy to apply, it provides an elasticity level of 300% while guaranteeing a traction force greater than 2.7N/mm².

Specifications:

- elastomer: 300% elasticity
- touch dry: 5-10min
- solvent-free



CO 1047

GREY GLUE AND MASTIC CARTRIDGE 310ml



CO 1048

BLACK GLUE AND MASTIC CARTRIDGE 310ml

NO WARRANTY

CO 1020

BLACK SEALANT CARTRIDGE -40/+250 DEGREES 200ml

Resistant to hydrocarbons



Allows joints to be sealed (sump, water pump, gearbox) and mechanical parts (fuel pumps, carburetors).

Also suitable for sealing headlights and electrical connections. Even adhesive in oil.
Slow skin formation (20 minutes) to work serenely during major operations (gear box turning type).

Specifications:

- elastomer: 400% elasticity
- resistant to high temperatures (250°C)
- drying by touch: 20min
- vacuum package, with trigger

NO WARRANTY



CO 1032

SUPPLE SUPER GLUE 20g



Rapid and instantaneous adhesion

Particularly adapted for sticking on interior rear-view mirrors. Quick connection.

Applications: fabrics, plastic, rubber, metal, elastomer, wood...etc
Universal cyano-acrylate glue, high viscosity



CO 1038

MEDIUM-STRENGTH THREAD LOCK 10ml



CO 1039

STRONG THREAD LOCK 10ml

Prevents assemblies subject to vibrations from unscrewing. Affixes screws/bolts and various threads while allowing easy removal (using tools).



Degreases, Cleans, Luster and Protects

CO 0400

80 CLEANSING MULTI PURPOSE WIPES

Can be used on all surfaces: bodywork, glazing, leather, interior/exterior plastics, fairings, optics, chrome, rims, exhausts...etc.

Specifications:

- waterless and rinse-free wipe
- honeycombed surface for better dirt trapping
- dimensions of wipes: 240x190mm

Optimum result when finishing with a microfiber fabric (CO 0401)



CO 0401

5 230g MICROFIBERS SET 380x380mm



CO 0500

90 CLEANSING WORKSHOP WIPES

Specially designed to clean the hands without rinsing, wiping or residues; the wipes also allow you to clean mechanical parts, tools, workbenches, bodywork, alloy wheels, instrument panels..etc

Specifications:

- double-sided: Smooth-rough
- plant-based solvents with high detergent qualities
- paraben-free
- packed in a bucket with carry grip handle

Double-sided: Smooth/rough
Gentle for the skin



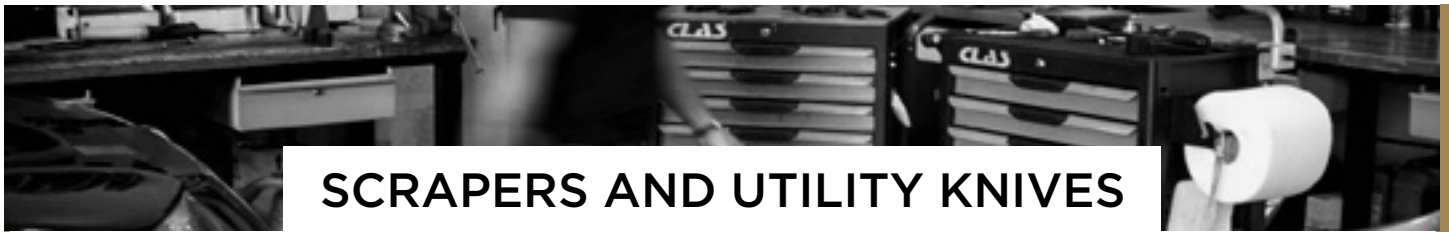

SCRAPERS AND UTILITY KNIVES

OC 0303

SCRAPER WITH HANDLE + 100 BLADES

Blade width: 38mm
Blade height: 19mm

Contents:
OC0304 : 1 x scraper with handle
OC5497 : 1 x 100 scraper blade set

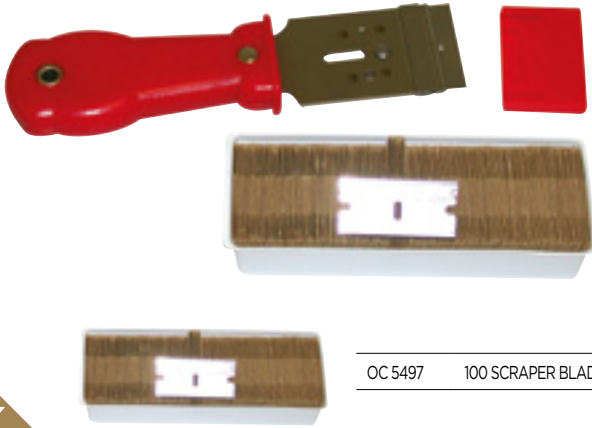

OC 5497 100 SCRAPER BLADE SET Spare part of OC 0303/OC 0304/OC 0305/OC 0306/OC 0307BL



OC 0306

RETRACTABLE SCRAPER
+ 100 BLADES

Blade width: 38mm
Blade height: 19mm

Contents:
OC0305 : 1 x retractable scraper
OC5497 : 1 x 100 scraper blade set



OC 0307BL

PLASTIC SCRAPER

B.LINE



Specifications:

- simple and quick blade changes
- blade protection sheath
- ergonomic
- blade width: 38mm



OC 0302

SCRAPER AND UTILITY KNIFE SET



OC 1915 10 PCS UNBREAKABLE BLADE SET

OC 1916 10 PCS BREAKABLE BLADE SET

OC 1920

LONG UTILITY
KNIFE



Blade width: 18mm

OC 1925

RETRACTABLE UTILITY KNIFE



Blade width: 18mm



CONTROL/MEASUREMENT

AC 0517

EXTERNAL MICROMETER
0-25mm

Calibration
certificate

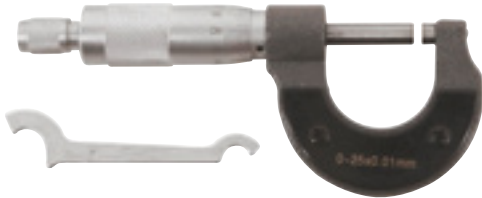

Specifications:

- tempered steel touch
- metal contact surface
- matt chrome-plated body, antireflection
- locking by lever



AC 0520

COMPARATOR+MAGNETIC
BASE PACK



Delivered with
calibration certificate

Comparator specifications (AC0514):

- measurement range 0 to 10mm
- travel/turn : 1mm
- resolution 0.01mm
- chromed-steel case Ø57mm
- fixing rod Ø8mm
- point zero locking screw

Magnetic base specifications (AC0515):

- joint locking
- magnetic base, attraction strength 80kg
- height: 235mm
- vertical stalk Ø12mm
- weight: 1,850kg



AC 0514 COMPARATOR WITH WORKING RANGE 0-10mm



AC 0528

MICROMETER 25-50mm



AC 5103

OPTICAL AND CONTACT TACHOMETER



This device is a portable digital tachometer which is used to measure the rotation speed. This compact tachometer has two methods of measurement: the first one is optical, thus without contact, the other one is mechanical by means of an adapter (3 sorts of adapters supplied).

The tachometer can be used to measure the speed of engines, pumps, turbines, centrifuges...

Supplied with 2 SA2404 reflective strips



AC 0515

MAGNETIC BASE FOR COMPARATORS



Specifications:

- joint locking
- magnetic base, attraction strength 80kg
- height: 235mm
- vertical stalk Ø12mm
- weight: 1,850kg



AC 0513**CALIPER BASE**

Calibration certificate

Specifications:

- from 0 to 150mm
- resolution 1/20mm
- depth gauge
- locking knob

**AC 0518****FEELER GAUGE SET****Specifications:**

- 20 blades
- 0.05 to 1mm
- resolution: 0.05mm

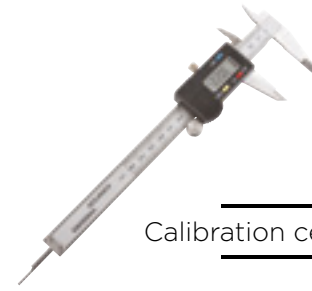
**AC 0511****DIGITAL CALIPER**

Calibration certificate

Specifications:

- from 0 to 150mm
- resolution: 0.01mm
- reset in any position

**AC 0530****50-160mm DRILLING INSPECTION DEVICE SET**

Allows to check the ovalization flaws of a drill hole from 50 to 160mm

Contents:

- 0.01mm resolution comparator
- cardan drill checker
- 12 pins L.50 to 105mm

**EG 1560****CAST IRON SURFACE PLATE FOR CHECKING HEAD FLATNESS**

Allows simple and precise control of surface flatness flaws such as cylinder heads. Up to 6 cylinder heads can be checked.

**Specifications:**

- strong ribbing for high rigidity
- reinforced edges
- tolerance: < 0.05mm
- weight: 80kg
- dimensions: L.800xI.500xH.90mm
- DIN 876





OM 8088

MAGNETIC PICK UP TOOL
Ø5mm L.525mm



OM 8086

MAGNETIC PICK UP TOOL Ø5mm
L.1070mm



OM 8074

TELESCOPIC MIRROR
228mm-715mm

Stainless steel mirror

63x45mm



OM 8071

TELESCOPIC MAGNET
170mm-670mm



- lifting capacity: 3.6kg
- magnet: Ø18mm



OM 8087

LONG FLEXIBLE MAGNETIC SHAFT

This tool allows small objects to be retrieved and picked up in confined areas. The 4 curved claws ensure a correct grip, and the powerful magnet is ideal for metallic objects.

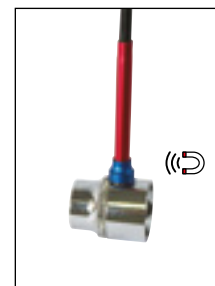
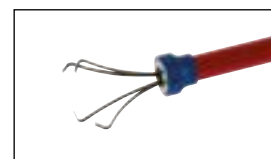

Technical data:

- total length: 700mm
- magnet Ø15mm
- flexible shaft and aluminum bracket

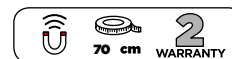

EG 0525

419 PCS O-RING JOINT SET

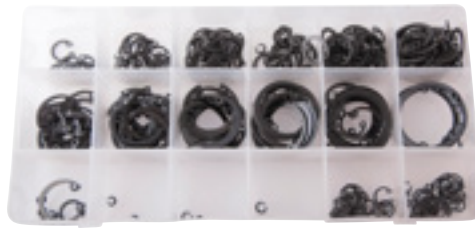
**CO 0527**

300 PCS 3-32mm EXTERNAL CIRCLIP SET

CO 0526

300 PCS 3-32mm INTERNAL CIRCLIP SET

Contents:

- 3mm x20
- 4mm x10
- 5mm x15
- 6mm x25
- 8 mm x15
- 9mm x20

- 11mm x15
- 12mm x15
- 13mm x25
- 14mm x15
- 16mm x20
- 19mm x25
- 20mm x15

- 22mm x20
- 25mm x15
- 26mm x15
- 28mm x10
- 32mm x5

NEW**CO 0525**300 PCS E TYPE EXTERNAL CIRCLIP SET
1.5-22mm**Contents:**

- 1.5mm x30
- 3mm x30
- 5mm x40
- 6mm x50

- 10mm x50
- 12mm x40
- 15mm x20
- 19mm x20
- 22mm x20



INDUCTION

OE 0900

HGV INDUCTION HEATER

This tool allows to heat a part in a precise place, thus facilitating the unlocking of screws, nuts, bolts, rods, hubs (even rusty), lambda probes, ball bearings... It also makes it easy to remove stickers, remove glued door sticks or HGV wheel nuts.



NEW



Increased security
Saving time



Specifications:

- frequency: 18-60kHz
- power: 3.7kVA
- power regulator: 10-100%.
- control screen and timer
- LED illumination of the work area
- water-cooled
- dimensions: 240x200x440mm
- weight: 11.5kg

Contents:

- remote induction central unit with 3m mains cable and 2m connecting cable (for accessibility)
- induction coil with side heating

SA 0901 3L COOLING LIQUID

IP 22
 5 m
 220V
 3700 W
 1 WARRANTY

OE 0610

INDUCTION HEATER

This tool allows a room to be heated in a precise area, meaning that nuts, screws, bolts, bolted connections, hubs (even if rusted), lambda probes, ball bearings can be unblocked...It also allows stickers to be easily removed and stuck door rods to be disassembled or HGV wheel screws to be removed.



Saving time

It is a real alternative to a blowtorch or a welding torch: induction enables the metal (conductive) to be heated with precision in a localised spot with no risk of damage to surrounding parts and cables (glass, plastic, paintwork...) implementation of the tool. Not only this, the operator saves a considerable amount of time when implementing the tool.

Contents:

- rigid induction coil Ø18mm, length 200mm
- rigid induction coil Ø22mm, length 200mm
- rigid induction coil Ø28mm, length 600mm
- bearing coil length
- plastic and foam case

900 W
 220V **1** WARRANTY

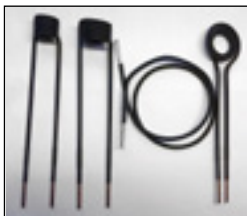

SA 0816	RIGID INDUCTION COIL Ø23mm	Spare part of OE 0800/OE 0610
SA 0817	ROUND INDUCTION PAD Ø50mm	Spare part of OE 0800/OE 0610
SA 0818	FLEXIBLE INDUCTION COIL	Spare part of OE 0800/OE 0610
SA 0819	RIGID INDUCTION COIL Ø19mm	Spare part of OE 0800/OE 0610
SA 0832	RIGID INDUCTION COIL Ø32mm	Spare part of OE 0800/OE 0610
SA 0838	RIGID INDUCTION COIL Ø38mm	Spare part of OE 0800/OE 0610

OE 0800

INDUCTION HEATER

This tool allows to heat a part in a precise place, thus facilitating the unlocking of screws, nuts, bolts, rods, hubs (even rusty), lambda probes, ball bearings... It also makes it easy to remove stickers, remove glued door sticks or HGV wheel nuts.



Improved security
Time gain

Specifications:

- frequency: 25-60kHz
- automatic overheating shutdown
- short-circuit and open circuit security, overload alarm
- dimensions: 200x140x75mm

Contents:

- deported induction central unit with 3m supply cable and 70cm connector (to improve accessibility)
- SA0819: rigid induction coil Ø19mm length 220mm
- SA0832: rigid induction coil Ø32mm length 220mm
- SA0818: flexible coil length 800mm
- SA0817: induction pad Ø50mm length 220mm
- shoulder strap
- plastic case with foam

1500 W
 3 m 220V **1** WARRANTY



AIR COMPRESSORS



Specifications:

- diameter: 600mm
- height: 2040mm
- weight: 123kg

OP 6850

PAINTED VERTICAL TANK 500l 11bar

- Supplied with:
- valves
 - manometer
 - gauge
 - reducers and plugs
 - hose 3/4 L.1500mm

OP 6856

PAINTED VERTICAL TANK 500l 16bar

- Supplied with:
- valves
 - gauge
 - reducers and plugs
 - hose 3/4 L.1500mm

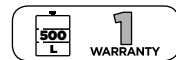

MORE

Selection for body repair

WORKERS	REF	DESIGNATION	POWER
WORKER 1	OP 6750	RECIPROCATING COMPRESSOR HOUSING SLOW MOVING 10CV	10 CV
	OP 7811	SCREW COMPRESSOR SOUNDPROOFED 20CV	20CV

Selection for workshop

WORKERS	REF	DESIGNATION	POWER	TANK
WORKER 1	OP 6270	BELT COMPRESSOR SLOW SPEED 270l 5.5CV	5.5 CV	270l
WORKER 2-3	OP 6555	LOW NOISE BELT COMPRESSOR SLOW SPEED 7CV	7 CV	NC
WORKERS 4-5 et +	OP 6500	BELT COMPRESSOR SLOW SPEED 500l 7.5CV	7,5 CV	500l
	OP 6750	RECIPROCATING COMPRESSOR HOUSING SLOW MOVING 10CV	10 CV	NC
WORKERS 5 et +	OP 6510	BELT COMPRESSOR SLOW SPEED 500l 10CV	10 CV	500l

For example, screw compressor systems are indispensable for continuous-usage applications and advisable for applications involving occasional language periods. Piston compressors are more suited to short-usage applications.

CLAS meets your specific needs.

Each compressor type has its own technical characteristics, which must be taken into account when choosing your compressor

Option HGV 13bar available

	Service life	Use capacity	Oil residues
Piston compressor	4 000 h max.	env. 50 %	env. 0,015 gr./m ³
Screw compressor	30 000 h	env. 100 %	env. 0,003 gr./m ³





OP 7811

SCREW COMPRESSOR SOUNDPROOFED 20CV

Direct transmission:
optimized power

Control panel for better maintenance management and optimization of machine data.

- swept volume: 111m³/h
- max pressure: 10bar
- connection 3/4
- engine horsepower: 20cv-15kW
- power supply: 400V TRI
- weight: 235kg
- dimensions: L.800xW.700xH.980mm

NEW



OP 6813 SPECIAL SYNTHETIC OIL FOR SCREW COMPRESSORS (5L)

400V **15 kW** **1** WARRANTY



OP 6750

RECIPROCATING COMPRESSOR HOUSING SLOW MOVING 10CV

Slow speed
800rpm

- swept volume: 74m³/h
- max pressure: 10bar
- engine horsepower: 10cv-7.5kW
- power supply: 400V TRI
- weight: 225kg
- dimensions: L.850xW.620xH.1100mm

400V **7500 W** **1** WARRANTY

OP 6555

LOW NOISE BELT COMPRESSOR SLOW SPEED 7CV

Slow speed
1000rpm

- swept volume: 50m³/h
- max pressure: 10bar
- engine horsepower: 7.5cv-5.5kW
- sound level: 65dB
- supply: 400V TRI

400V **5500 W** **1** WARRANTY

OP 6910

SCREW SUPERCHARGER 15CV EQUIPPED WITH DRYER+500L TANK 10bar

Compact
3 in 1: compressor +
dryer + tank



Optimized piece of equipment combining a powerful screw supercharger, air dryer and high capacity tank with a minimum of space. Ideal for garages and body shops with high air consumption, up to 5 operators or more +.

Specifications:

- soundproofed screw compressor
- direct drive, optimized power
- swept volume: 93m³/h
- max. pressure: 10bar
- engine power: 15CV-11kW
- connector 3/4"
- type of dryer: by direct expansion refrigeration
- dew point of the dryer: 3°C
- electric supply: 400V-50Hz TRI
- weight: 422kg



OP 6813 SPECIAL SYNTHETIC OIL FOR SCREW COMPRESSORS (5L)

66 dB IP 54 500 L 400V 11 kW 1 WARRANTY

OP 6510

BELT COMPRESSOR SLOW SPEED 500L 10CV

- swept volume: 77m³/h
- max pressure: 10bar
- engine horsepower: 10cv-7.5kW
- power supply: 400V TRI
- weight: 360kg
- dimensions:L.2000xW.610xH.1270mm

500 L 400V 7500 W 1 WARRANTY



Slow speed
1000rpm

OP 6500

BELT COMPRESSOR SLOW SPEED 500L 7.5CV

- swept volume: 58m³/h
- max pressure: 10bar
- engine horsepower: 7.5cv-5.5kW
- power supply: 400V TRI
- weight: 310kg

500 L 400V 5500 W 1 WARRANTY

OP 6270

BELT COMPRESSOR SLOW SPEED 270L 5.5CV

- swept volume: 35m³/h
- max pressure: 9bar
- engine horsepower: 5.5cv-4kW
- power supply: 400V TRI
- weight: 171kg
- dimensions: L.1550xW.600xH.110mm

270 L 400V 2200 W 1 WARRANTY

OP 6223

AIR COMPRESSOR 200I 3CV SINGLE-PHASE

- swept volume: 20m³/h
- max pressure: 10bar
- engine horsepower: 3cv-2.2kW
- power supply: mono 220V
- equipped with regulator
- visible oil level











OP 6814 SPECIALIST SYNTHETIC OIL FOR PISTON COMPRESSORS (2L) Spare part of OP 6223/OP 6150/OP 6103/OP 6252/OP 6555/OP 6500/OP 6750/OP 6510/OP 6270

OP 6103

AIR COMPRESSOR 100I 3CV SINGLE-PHASE

- swept volume: 20m³/h
- max pressure: 10bar
- engine horsepower: 3cv-2.2kW
- power supply: mono 220V
- tank capacity: 100l
- equipped with regulator
- visible oil level









OP 6150

MONOPHASE AIR COMPRESSOR 150I 3CV

- swept volume: 20m³/h
- max pressure: 10bar
- engine horsepower: 3cv-2.2kW
- power supply: mono 220V
- equipped with regulator
- visible oil level











OP 6252

AIR COMPRESSOR 50I 2CV SINGLE-PHASE

- swept volume: 13m³/h
- max pressure: 8bar
- engine horsepower: 2cv-1.5kW
- power supply : mono 220V
- cast iron assembly
- carrying handle
- pressure reducer and filter



PIPE FITTINGS

KR 6032

ALUMINUM AIR PIPE AND FITTING KIT Ø32mm L.60M 8 DOWNPIPES

NEW

Aluminum components for tubes, and technopolymer fittings make this system a safe, durable network, with no risk of corrosion or pipe deformation.

Economical, thanks to its quick assembly: no gluing, no welding or crimping, works by interlocking, locking. High adaptability with these multiple connectors, and by its compatibility for existing network recovery.

The kit can be modulated at any time and allows an economic projection at any time (estimate not essential). Mounting accessories: see website.

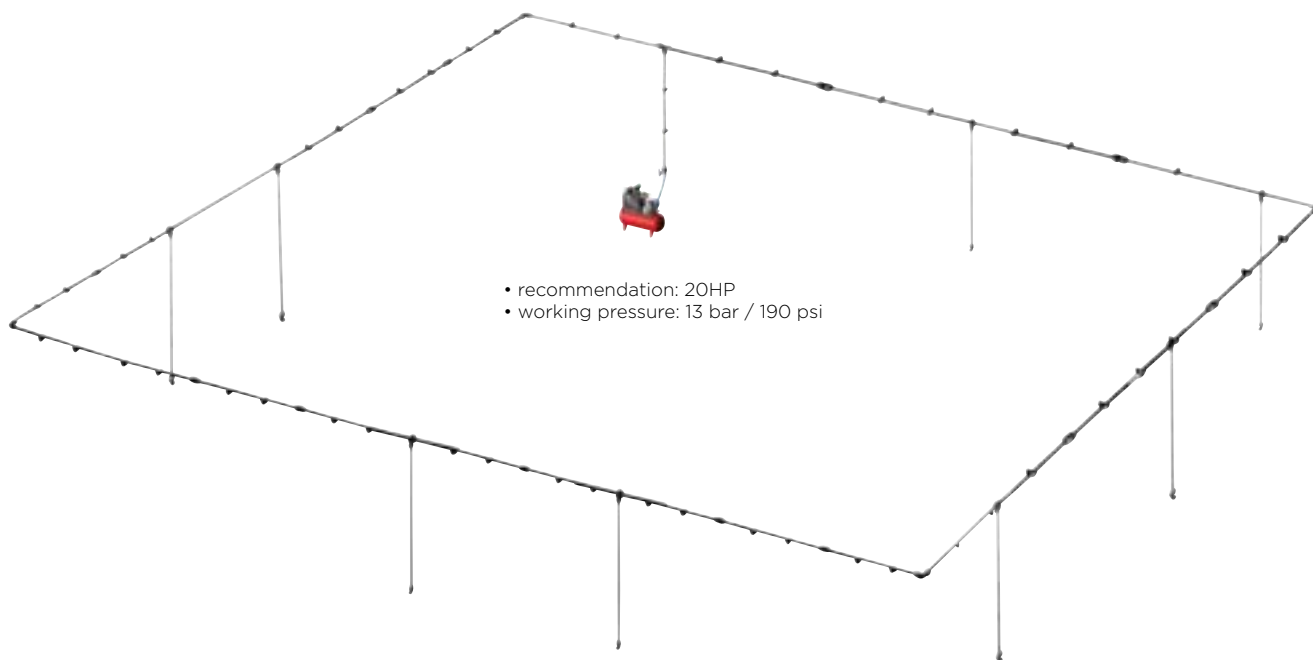

Contents:

- 30 blue aluminum pipes (2m per pole - Ø32mm)
- 16 blue aluminum pipes (2m per pole - Ø20mm)
- 15 KR7017 composite sleeve Ø32mm
- 30 KR7012 clamps 32mm M8
- 20 KR7010 clamps 20mm M8
- 6 KR7007 composite elbows 90° for Ø32mm
- 8 KR7046 composite tapping flanges for pipe Ø32xØ20
- 2 KR7076 equal composite tees Ø32mm
- 1 KR7025 cap Ø32mm
- 8 female wall brackets 1 exit
- 2M multilayer bending pipe
- 2M compressor connection pipping hose M1.1/2"x1"F
- 1 female threaded valve 32x1.1/2"
- 1 KR7054 special wrench nut tightening Ø16 to Ø20
- 1 KR7055 special wrench nut tightening Ø25 to Ø32



Aluminum components for tubes, and technopolymer fittings make this system a safe, durable network, with no risk of corrosion or pipe deformation.

Economical, thanks to its quick assembly: no gluing, no welding or crimping, works by interlocking, locking.

High adaptability with these multiple connectors, and by its compatibility for existing network recovery.

The kit can be modulated at any time and allows an economic projection at any time (estimate not essential).

Mounting accessories: see website.

NEW



KR 2016

ALUMINUM AIR PIPE AND FITTING KIT Ø16mm L.20M 3 DOWNPIPES

Contents:

- 10 blue aluminum pipes (2m per pole - Ø16mm)
- 5 KR7014 composite sleeve Ø16mm
- 20 KR7009 clamps 16mm M8
- 3 KR7004 composite elbows 90° for Ø16mm
- 2 KR7073 equal composite tees Ø16mm
- 1 KR7081 composite tapered male threaded straight fitting Ø16xM1/2"G
- 3 KR7069 aluminum female wall brackets 1/2"x1/2"G
- 2M compressor connection pipping hose M1/2"x1/2"F
- 1 KR7027 male threaded valve Ø16mm 1/2"G
- 1 KR7054 special wrench nut tightening Ø16 to Ø20

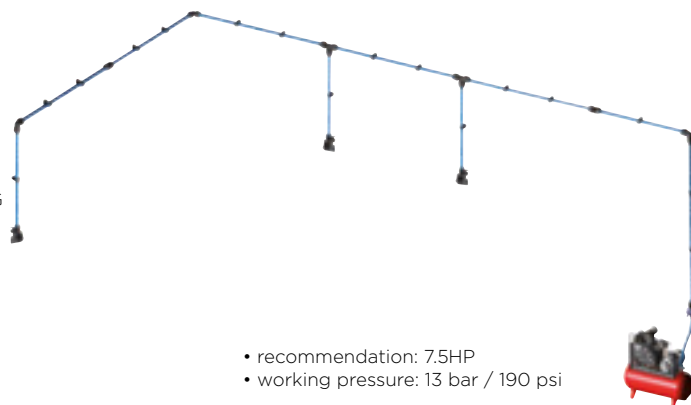

- recommendation: 7.5HP
- working pressure: 13 bar / 190 psi

KR 3020

ALUMINUM AIR PIPE AND FITTING KIT Ø20mm L.30M 4 DOWNPIPES

Contents:

- 15 blue aluminum pipes (2m per pole - Ø20mm)
- 5 KR7015 composite sleeve Ø20mm
- 30 KR7010 clamps 20mm M8
- 4 KR7005 composite elbows 90° for Ø20mm
- 3 KR7074 equal composite tees Ø20mm
- 4 KR7082 composite tapered male threaded straight fitting Ø20xM1/2"G
- 3 female wall brackets 1 exit
- 2M compressor connection pipping hose M1/2"x1/2"F
- 1 KR7051 valve for pipe Ø25 female threaded F 3/4"G
- 1 KR7054 special wrench nut tightening Ø16 to Ø20

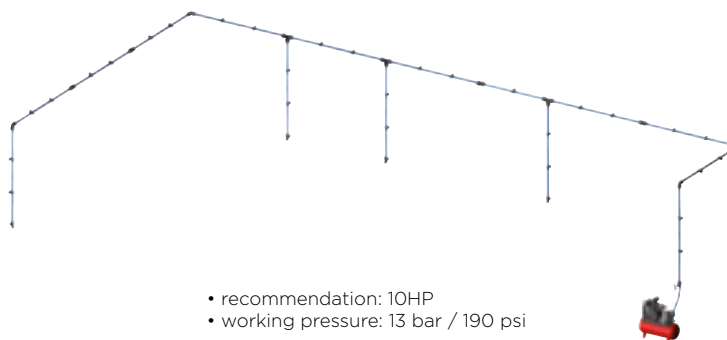

- recommendation: 10HP
- working pressure: 13 bar / 190 psi

KR 4425

ALUMINUM AIR PIPE AND FITTING KIT Ø25mm L.36M 5 DOWNPIPES

Contents:

- 18 blue aluminum pipes (2m per pole - Ø25mm)
- 5 blue aluminum pipes (2m per pole - Ø20mm)
- 9 KR7016 composite sleeve Ø25mm
- 40 KR7011 clamps 25mm M8
- 10 KR7010 clamps 20mm M8
- 5 KR7006 composite elbows 90° for Ø25mm
- 5 KR7065 composite tees reduced on center Ø25X20
- 1 KR7075 equal composite tee Ø25mm
- 1 KR7085 composite tapered male threaded straight fitting Ø25xM1/2"G
- 1 KR7024 cap Ø25mm
- 3 female wall brackets 1 exit
- 2M compressor connection pipping hose M3/4"x3/4"F
- 1 KR7050 valve for pipe Ø20 female threaded F 1/2"G
- 1 KR7054 special wrench nut tightening Ø16 to Ø20
- 1 KR7055 special wrench nut tightening Ø25 to Ø32

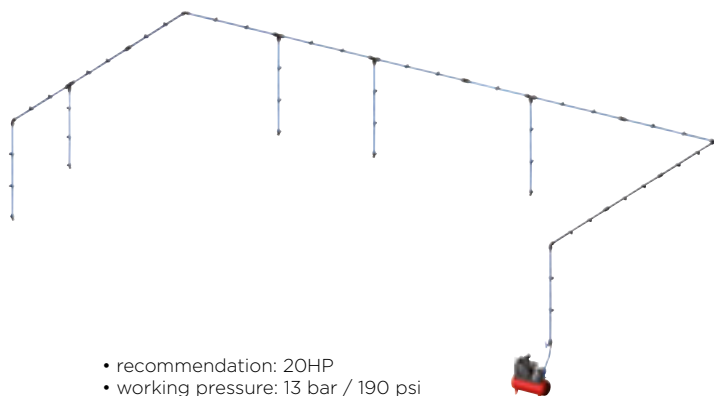

- recommendation: 20HP
- working pressure: 13 bar / 190 psi



COMPOSITE ELBOW 45°

KR 7000	COMPOSITE ELBOW 45° FOR Ø20mm
KR 7001	COMPOSITE ELBOW 45° FOR Ø25mm
KR 7002	COMPOSITE ELBOW 45° FOR Ø32mm
KR 7003	COMPOSITE ELBOW 45° FOR Ø40mm

NEW



5
WARRANTY

COMPOSITE ELBOW 90°

KR 7004	COMPOSITE ELBOW 90° FOR Ø16mm
KR 7005	COMPOSITE ELBOW 90° FOR Ø20mm
KR 7006	COMPOSITE ELBOW 90° FOR Ø25mm
KR 7007	COMPOSITE ELBOW 90° FOR Ø32mm
KR 7008	COMPOSITE ELBOW 90° FOR Ø40mm

NEW



5
WARRANTY

CLAMP M8

KR 7009	CLAMP 16mm M8
KR 7010	CLAMP 20mm M8
KR 7011	CLAMP 25mm M8
KR 7012	CLAMP 32mm M8
KR 7013	CLAMP 40mm M8

NEW



5
WARRANTY

COMPOSITE SLEEVE

KR 7014	COMPOSITE SLEEVE Ø16mm
KR 7015	COMPOSITE SLEEVE Ø20mm
KR 7016	COMPOSITE SLEEVE Ø25mm
KR 7017	COMPOSITE SLEEVE Ø32mm
KR 7018	COMPOSITE SLEEVE Ø40mm

NEW



5
WARRANTY

ALUMINUM DIVERSION

KR 7019	ALUMINUM DIVERSION Ø20mm
KR 7020	ALUMINUM DIVERSION Ø25mm
KR 7021	ALUMINUM DIVERSION Ø16mm

NEW



5
WARRANTY

CAP

KR 7022	CAP Ø16mm
KR 7023	CAP Ø20mm
KR 7024	CAP Ø25mm
KR 7025	CAP Ø32mm
KR 7026	CAP Ø40mm

NEW



5
WARRANTY

WALL MOUNTING RENFORT

KR 7028	WALL MOUNTING RENFORT Ø20mm
KR 7029	WALL MOUNTING RENFORT Ø25mm
KR 7033	THREADED ALUMINUM WALL LIGHT IN-OUT-F1/2G
KR 7034	THREADED ALUMINUM WALL LIGHT IN-OUT-F3/4G

NEW



5
WARRANTY

FLEXIBLE LINK

KR 7030	FLEXIBLE LINK Ø25mm
KR 7031	FLEXIBLE LINK Ø32mm
KR 7032	FLEXIBLE LINK Ø40mm

NEW



5
WARRANTY

ALUMINUM PIPE LENGTH 4M

NEW

KR 7035	ALUMINUM PIPE Ø16mm LENGTH 4M
KR 7036	ALUMINUM PIPE Ø20mm LENGTH 4M
KR 7037	ALUMINUM PIPE Ø25mm LENGTH 4M
KR 7038	ALUMINUM PIPE Ø32mm LENGTH 4m
KR 7039	ALUMINUM PIPE Ø40mm LENGTH 4M



5 WARRANTY

COMPOSITE TAPPING FLANGE FOR PIPE

NEW

KR 7043	COMPOSITE TAPPING FLANGE FOR PIPE Ø25xØ16
KR 7044	COMPOSITE TAPPING FLANGE FOR PIPE Ø25xØ20
KR 7045	COMPOSITE TAPPING FLANGE FOR PIPE Ø32xØ16
KR 7046	COMPOSITE TAPPING FLANGE FOR PIPE Ø32xØ20
KR 7047	COMPOSITE TAPPING FLANGE FOR PIPE Ø40xØ16
KR 7048	COMPOSITE TAPPING FLANGE FOR PIPE Ø40xØ20
KR 7049	COMPOSITE TAPPING FLANGE FOR PIPE Ø40xØ25



5 WARRANTY

MALE THREADED VALVE

NEW

KR 7027	MALE THREADED VALVE Ø16mm 1/2 "G
KR 7050	VALVE FOR PIPE Ø20 FEMALE THREADED F 1/2 "G
KR 7051	VALVE FOR PIPE Ø25 FEMALE THREADED F 3/4 "G
KR 7052	VALVE FOR PIPE Ø20 MALE THREADED 1/2 "G
KR 7053	VALVE FOR PIPE Ø25 MALE THREADED 3/4 "G
KR 7057	PIPPING VALVE Ø25
KR 7058	PIPPING VALVE Ø32
KR 7059	PIPPING VALVE Ø40



MALE THREADED VALVE



PIPPING VALVE Ø32



VALVE FOR PIPE Ø20 MALE THREADED

5 WARRANTY

SPECIAL WRENCH NUT TIGHTENING

NEW

KR 7054	SPECIAL WRENCH NUT TIGHTENING Ø16 TO Ø20
KR 7055	SPECIAL WRENCH NUT TIGHTENING Ø25 TO Ø32
KR 7056	SPECIAL WRENCH NUT TIGHTENING Ø40 TO Ø50



5 WARRANTY

KR 7040

CHAMFERING TOOL Ø16mm TO Ø50mm



NEW

5 WARRANTY

KR 7041

PIPE INSERTION CONTROL GAUGE Ø16mm TO Ø50mm



NEW

5 WARRANTY

KR 7042

SILICONE FREE ASSEMBLY GEL



NEW

950 ml 5 WARRANTY

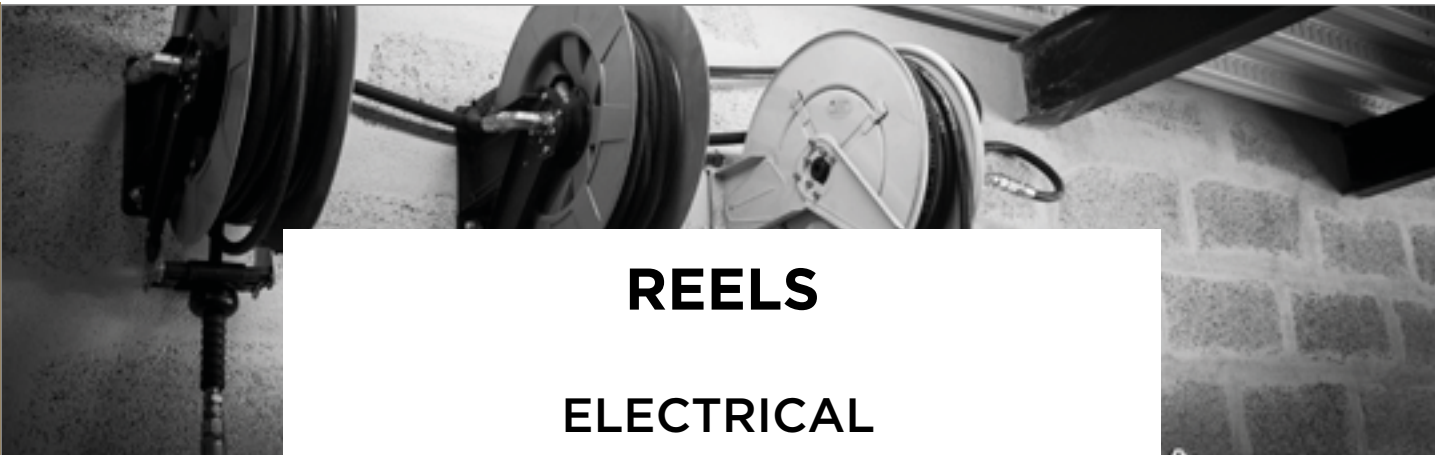

REELS

ELECTRICAL

OE 0041

MOBILE ELECTRICAL REEL 3x2.5mm² 20m

Specifications:

- Maximum power:
3200W (unwound cable)
1100W (wound cable)
- 4 sockets with dust flaps
- red led/cut out in case of overheating
- 3 conductors 2.5mm²
- cable HO7 RN-F

NEW



3200
 20 m **W** **1**
 WARRANTY



OE 0051

MOBILE ELECTRICAL REEL 3x2.5mm² 40m

NEW

Specifications:

- Maximum power:
3200W (unwound cable)
1100W (wound cable)
- 4 sockets with dust flaps
- red led/cut out in case of overheating
- 3 conductors 2.5mm²
- cable HO7 RN-F



3200
 40 m **W** **1**
 WARRANTY

OE 0052WORKSHOP CABLE REEL 3x1.5mm² 20m

- ABS drum
- maximum strength:
2300W (unrolled cable)
1000W (unrolled cable)
- IP rating: IP44
- thermal circuit breaker
- 3 conductors 1.5mm²
- cable HO7 RN-F-20m
- waterproof plug



IP 44  20 m **1000**
2300
W **1**
WARRANTY

OE 0423REEL 3x2.5mm² 20m

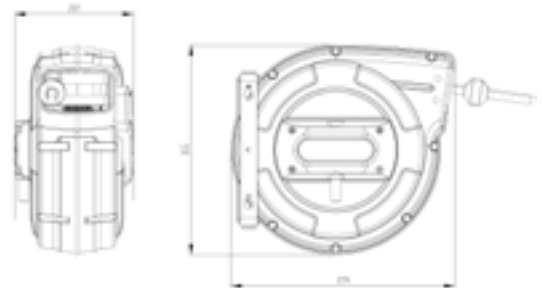
Automatic cable
spacing when rolled
up

**Specifications:**

- max. capacity: 3200W
- automatic spacing/scanning cable guide
- stop device every 50cm (can be deactivated)
- wall support 180°
- IED indicating the presence of voltage
- overheating and overloading protection
- utilization temperature -5°/+56°

 IP 44  20 m **3200**
W **1**
WARRANTY



OE 2000

**TYPE 2 WALLBOX WIFI REEL FOR ELECTRIC VEHICLE
POWER SUPPLY**

NEW

**Charging status via
wifi connection**



Allows the vehicle to be recharged during the operation. Safe and functional, this incorporated callbox reel is destined to recharging electric vehicles. It works with wifi connection which allows to follow up power and recharge with a smartphone. It is compliant to Mode 3 of international standard IEC 61851-1. A European standard charging socket VDE-AR-E-2623-2-2 Type 2. MAX 32A 230V / 32A 400V It can be used both for single-phase and threes-phase charging operations.

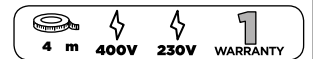

OE 2001

**TYPE 1 WALLBOX WIFI REEL FOR ELECTRIC VEHICLE
POWER SUPPLY**

Allows the vehicle to be recharged during the operation. Safe and functional, this incorporated callbox reel is destined to recharging electric vehicles. It works with wifi connection which allows to follow up power and recharge with a smartphone. It is compliant to Mode 3 of international standard IEC 61851-1. A North-American and Japanese standard charging socket Type 1 SAE J1772-2009 Type 1. MAX 32A 230V It can be used both for single-phase and threes-phase charging operations.



- blue: in charge
- green: charging finish
- red: error

NEW

**Charging status via
wifi connection**

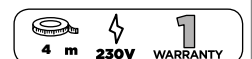

AIR & WATER

OP 0082BL

METAL CASE REEL Ø8mm



B.LINE



Metal casing

- stop device every 50cm
- hose Øint. 8mm
- connector 1/4"
- adjustable wall support 180°
- tension by high-strength spring
- pressure 8bar



OP 0701 FAST CONNECTOR PASSAGE 6mm FEMALE 1/4"

Accessory of OP 0082BL/OP 1115/OP 1117

OP 0901 10 IRP ENDS 6mm PASSAGE FEMALE 1/4"

Accessory of OP 0082BL/OP 1115/OP 1117/OP 0425



OP 0099

STRAIGHT BLOWGUN PEN



- pocket blowgun
- adjustable flow
- duralumin body
- length 110mm
- opening/closure by rotation



OP 0420

VARIABLE BLOWGUN BLUE METALLIC NOZZLE



Specifications:

- Fluid: Air
- Brass insert: G1/4-F
- Gradual blowing
- Nominal pressure: 10bar
- Temperature: -15°C+70°C
- Material: Composite antistatic
- Air flow 384l/min

Metallic steel nozzle: Ø3x6mm
110mm elbow tube



OP 0046BL

INFLATING GUN 0-12bar



B.LINE



Scale of 0 to 12 bar
Flexible length: 50mm



OP 0049

INFLATOR GUN 0.7-12bar



- for passenger cars and vans.
- complies with directive 86/217/EEC
- standard UNI EN 12645
- graduations of 0.7 to 12bar



OP 1115

AIR REEL Ø8mm 16m

Automatic cable spacing when rolled up



- automatic spacing/scanning cable guide
- stop device every 50cm (can be deactivated)
- dust-tight bearing
- pipe: Øint. 8mm
- connector: 1/4"
- swiveling wall support 180°
- operating pressure: 12bar
- max. pressure: 30bar



OP 0901 10 IRP ENDS 6mm PASSAGE FEMALE 1/4"

Accessory of OP 0082BL/OP 1115/OP 1117/OP 0425



OP 0701 FAST CONNECTOR PASSAGE 6mm FEMALE 1/4"

Accessory of OP 0082BL/OP 1115/OP 1117

OP 1117

AIR REEL Ø10mm 16m

Automatic cable spacing when rolled up

- automatic spacing/scanning cable guide
- stop device every 50cm (can be deactivated)
- dust-tight bearing
- pipe: Øint. 10mm
- connector: 1/4"
- swiveling wall support 180°
- operating pressure: 12bar
- max. pressure: 30bar



OP 1017

AIR REEL Ø10mm 16m

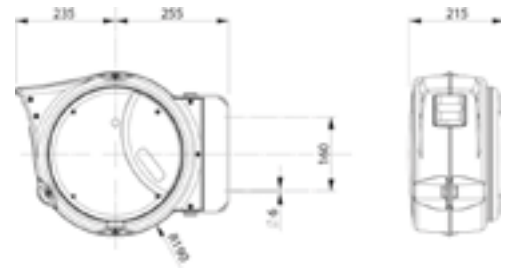

ABS housing

- stop device every 50cm
- hose Øint. 10mm
- connector 3/8"
- adjustable wall support 180°
- max. pressure 15bar
- tension by high

Option: 4 other colors available



OP 0907	10 IRP ENDS 6mm PASSAGE FOR HOSES Ø10mm	Accessory of OP 1017
OP 0702	FAST CONNECTOR PASSAGE 6mm FEMALE 3/8"	Accessory of OP 1017

16 m **2** WARRANTY

OP 1628

HGV AIR REEL Ø13mm 20m

Pneumatic connectors
p. 74

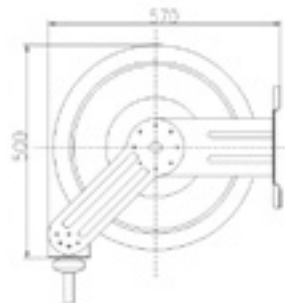
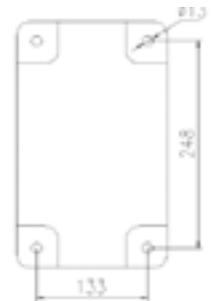

- epoxy powder coated steel brackets
- automatic hose stopping system
- hose Øint. 13mm
- max. pressure: 20bar
- connector 1/2"

20 m **2** WARRANTY

OP 1126

HIGH PRESSURE AIR/WATER REEL Ø10mm 20m 280bar

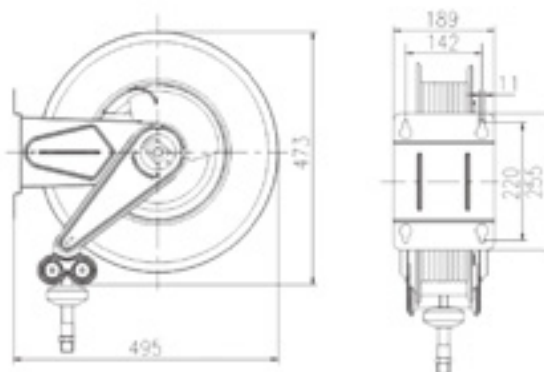

- epoxy powder coated steel brackets
- automatic hose stopping system
- reinforced hose SAE 100R1AT
- hose Øint. 10mm
- max pressure 200bar
- hot water max 100°C
- connector 3/8"



EG 0017

PIT PROTECTION COVER REEL 20m

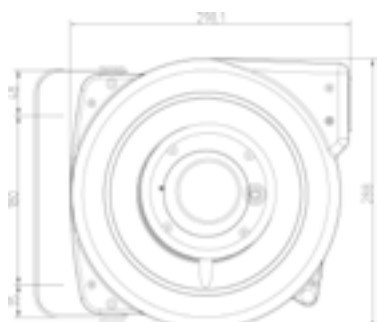

- To signal and define a pit or a dangerous area.
Reduces the risk of accidents.
- equipped with a hook to facilitate the delimitation
 - anti-UV band
 - band width: 40mm
 - 180° wall support
 - stop device every 50cm



OIL - GREASE

HU 1316

OIL REEL Ø10mm 15m 153bar



- epoxy powder coated steel brackets
- automatic hose stopping system
- reinforced hose SAE 100R2AT
- hose Øint. 10mm
- length 15m, 150°C
- max pressure 153bar
- connector 3/8"



HU 1818

GREASE HOSE REEL Ø8mm 20m 350bar



- epoxy powder coated steel brackets
- stop device every 50cm
- reinforced hose SAE 100R2AT
- hose Øint. 8mm
- length 20m
- max pressure 350bar
- connector 1/4"



HU 0617

DIGITAL VOLUMETRIC GUN 1/2"
OIL/ANTIFREEZE

This gun ensures simple, rapid and measured distribution.
For oil and anti-freeze.

Specifications:

- variable flow speed: 0-35l/min
- max. pressure: 100bar
- precision: ±0.5%
- swivel connector 1/2"
- automatic anti-drip hose bit L.180mm
- locking handle clip
- 3V 1400mAh battery
- autonomous operation: 8 years / 500,000L



CONNECTORS

MORE

- 1- first translatory movement rearwards : immediate decompression
- 2- second translatory movement forward : immediate disconnection

CLAS connections comply with the international safety standards ISO 4414 and DIN EN 983.

The cylindrical monoblock construction in shockproof composite materials, associated with a metallic insert, allows to ensure longevity and reliability.

Connections and disconnections are made immediately and effortlessly. The mechanism of waterproofness associated with tips, eliminates any leaks in coupled or uncoupled position.

Corrosion protection

Tip in treated steel

Respect of dimensions and tolerances

Pre-floating of male threads

Threads matches

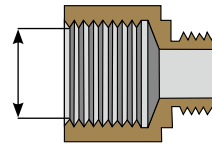

Female thread:

- G 1/8" ≈ 8,6mm
- G 1/4" ≈ 11,5mm
- G 3/8" ≈ 15mm
- G 1/2" ≈ 18,6mm
- G 3/4" ≈ 24,1mm

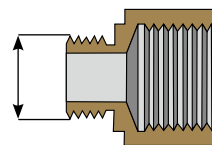

Male thread:

- G 1/8" ≈ 9,7mm
- G 1/4" ≈ 13,2mm
- G 3/8" ≈ 16,7mm
- G 1/2" ≈ 21mm
- G 3/4" ≈ 26,4mm

Pictogram legends:



Pneumatic tools



Painting guns



Flexibles



FRL



Grid wall lamp



Reels

ERP ENDS (x10) PASSAGE Ø7.2mm

FAST CONNECTORS Ø7.2mm EUROPEAN PROFILE



	SIZE	MALE THREAD	FEMALE THREAD	REF.	
	1/4"		•	OP 0917	
	1/4"	•		OP 0918	
	Ø8mm			OP 0919	
	Ø10mm			OP 0920	







	SIZE	MALE THREAD	FEMALE THREAD	REF.	
	1/4"		•	OP 0717	
	3/8"		•	OP 0718	
	1/2"		•	OP 0719	
	1/4"	•		OP 0720	
	3/8"	•		OP 0721	
	1/2"	•		OP 0722	
	Ø8mm			OP 0723	
	Ø10mm			OP 0724	









Ø7.2mm passage is recommended for painting applications.

IRP ENDS (x10) PASSAGE Ø6mm

 ø6mm passage is recommended for LV workshop.









	SIZE	MALE THREAD	FEMALE THREAD	REF.	
	1/4"		•	OP 0901	
	3/8"		•	OP 0902	
	1/4"	•		OP 0903	
	3/8"	•		OP 0904	
	Ø8mm			OP 0906	
	Ø10mm			OP 0907	







	SIZE	MALE THREAD	FEMALE THREAD	REF.	
	1/4"		•	OP 0701	
	3/8"		•	OP 0702	
	1/2"		•	OP 0703	
	1/4"	•		OP 0704	
	3/8"	•		OP 0705	
	1/2"	•		OP 0706	
	Ø8mm			OP 0708	
	Ø10mm			OP 0709	

IRP ENDS (x10) PASSAGE Ø8mm

 ø8mm passage is recommended for HVL workshop.



	SIZE	MALE THREAD	FEMALE THREAD	REF.	
	1/4"		•	OP 0908	
	3/8"		•	OP 0909	
	1/2"		•	OP 0910	
	1/4"	•		OP 0911	
	3/8"	•		OP 0912	
	1/2"	•		OP 0913	
	Ø8mm			OP 0914	
	Ø10mm			OP 0915	
	Ø13mm			OP 0916	

	SIZE	MALE THREAD	FEMALE THREAD	REF.	
	3/8"		•	OP 0710	
	1/2"		•	OP 0711	
	3/8"	•		OP 0712	
	1/2"	•		OP 0713	
	Ø8mm			OP 0715	
	Ø13mm			OP 0716	



BLOWGUNS



OP 0420

VARIABLE BLOWGUN BLUE METALLIC NOZZLE

Metallic steel nozzle: Ø3x6mm
110mm elbow tube

Specifications:

- Fluid: Air
- Brass insert: G1/4-F
- Gradual blowing
- Nominal pressure: 10bar
- Temperature: -15°C+70°C
- Material: Composite antistatic
- Air flow 384l/min



SA 6206

OILER



OP 0099

STRAIGHT BLOWGUN PEN



- pocket blowgun
- adjustable flow
- duralumin body
- length 110mm
- opening/closure by rotation



OP 0375

1/4 AIR SPIRAL HOSE L.7.5m



OP 0727

4 UNIVERSAL FAST TAPPED CONNECTOR SET FEMALE 1/4"

Accessory of SA 6002

Universal fast connector to link different bits profile (EU, US...) in one and unique connector.



Universal





TIGHTNESS/RELEASE

OP 1510

1/4"-3/8" D. MINI RATCHET WRENCH KIT

Specifications:

- speed: 850rpm
- max torque: 40.7Nm
- consumption: 113l/min
- length: 155mm
- 3 positions: forward/reverse/fixed

Contents:

- connector
- SA1510: square reversible adapter 1/4"-3/8"
- bit holder adapter

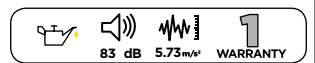

OP 1413

3/8" D. RATCHET WRENCH



Connector supplied

- Quiet
- Integrated speed regulator
- Needle bearing
- Reinforced head
- Ergonomic handle
- Reversible
- Swiveling connector
- Rear exhaust

Specifications:

- max. torque: 68Nm
- working torque: 14 to 68Nm
- speed: 150rpm
- length: 256mm
- connection: 1/4"
- supply pressure: 6.2bar
- consumption: 113l/min

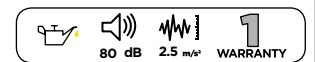

OP 1418

3/8" D. BUTTERFLY IMPACT WRENCH KIT



Contents:

- connector
- 3/8" butterfly impact wrench
- 8 sockets: 8-10-11-12-13-14-17-19mm
- 1x3" extension
- 1 bit holder

Specifications:

- speed: 10,000rpm
- drive: 3/8" (10mm)
- working torque range: 7-68Nm
- max torque reverse: 122Nm
- air inlet: 1/4"
- air consumption: 85l/min
- length: 140mm

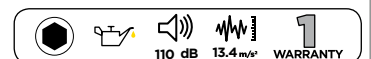

OP 1209

1/2" D. RATCHET WRENCH



- quiet
- light
- integrated speed regulator
- needle bearing
- reinforced head
- ergonomic handle
- reversible
- swiveling connector
- rear exhaust



Specifications:

- max. torque: 68Nm
- working torque: 14 to 68Nm
- speed: 150rpm
- length: 256mm
- connection: 1/4"
- supply pressure: 6.2bar
- consumption: 113l/min

Connector supplied

80 dB 2.5 m/s² WARRANTY 1

OP 1513

1/2" D. COMPACT IMPACT WRENCH 1084Nm DOUBLE HAMMER



Only 120mm long

NEW

Specifications:

- maximum torque: 1084Nm
- speed of rotation: 9,000 rpm
- connection: 1/4"
- Ø recommended hose Ø: 10mm
- supply pressure: 6.2bar
- consumption: 170l/min
- net weight: 1.2kg

The ergonomic and compact design offers more comfort.

- Lightweight, aluminium engine housing
- 4 position dimmer
- Double hammer technology
- Exhaust handle

80 dB 2.5 m/s² WARRANTY 1



CO 1218 CLEANER/LUBRICANT SPRAY FOR PNEUMATIC TOOLS

OP 1419 EXHAUST PNEUMATIC SLEEVE FOR 1/2" AND 3/8" IMPACT WRENCHES

Accessory of OP 1501/OP 1402/OP 1432

OP 1502

1/2" D. IMPACT WRENCH 1492Nm DOUBLE HAMMER



NEW

- Lightweight, composite engine housing
- 4 position dimmer
- Double hammer technology
- Exhaust handle

Specifications:

- maximum torque: 1492Nm
- loosening torque: 1000Nm
- speed: 7,500 rpm
- length: 185mm
- connection: 1/4"
- Ø recommended hose Ø: 10mm
- supply pressure: 6.2bar
- consumption: 184l/min
- net weight: 2.0kg

89.9 dB 6.8 m/s² WARRANTY 1

OP 1402

1/2" D. IMPACT WRENCH 1756Nm



For working on the chassis of commercial vehicles

- Powerful
- Light
- Composite motor housing
- 3-position regulator
- Lock/unlock hand toggle
- Double-hammer technology
- Swivelling connector
- Handle exhaust

Specifications:

- max. torque: 1756Nm
- release torque: 1112Nm
- speed: 7,000rpm
- length: 183mm
- connection: 1/4"
- supply pressure: 6.2bar
- consumption: 113l/min
- net weight: 1.9kg

Connector supplied

83 dB WARRANTY 1



OP 1532

1/2" IMPACT WRENCH SET 13 PCS

NEW

Contents:

- OP1502: impact wrench 1/2" D. 1492Nm
- OP1431: impact wrenches accessory set 1/2" 12 pcs



Impact socket at retail
p. 111



One-handed torquing/loosening with safety position.
Change sockets quickly, supported by a safety ring.
Rubber sleeve for improved grip
LED illumination for the work area



OE 2060

1/2" RECHARGEABLE IMPACT WRENCH 600Nm

Spare part of OE 2065

Supplied in a composite case with a charger and 1 battery (SA2605)

OE 2065

1/2" RECHARGEABLE IMPACT WRENCH
600Nm+ADDITIONAL BATTERY

Supplied in a composite case with a charger and 2 batteries (SA2605)



Specifications:

- maximum torque: 600Nm
- speed: 0-1600rpm
- impacts per minute: 0-3200bpm
- battery: Li-ion 18V 4.0Ah
- charger with charge-level indicator
- length: 235mm

SA 2605 4.0Ah LI-ION BATTERY

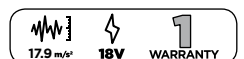

OP 1405

3/4" D. IMPACT WRENCH
1898Nm



- Powerful
- Light. Composite motor housing
- 3-position regulator
- Lock/unlock one-handed toggle
- Double-hammer technology
- Swiveling connector
- Handle exhaust

Specifications:

- max. torque: 1898Nm
- release torque: 1627Nm
- speed: 5,500rpm
- length: 215mm
- connection: 3/8"
- supply pressure: 6.2bar
- consumption: 198l/min
- net weight: 3.3kg

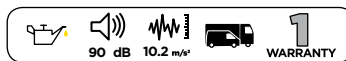

OP 1409

1" D. ALUMINUM IMPACT
WRENCH 2034Nm



- Powerful
- 3-position regulator
- One-handed lock/unlock hand toggle
- Double-hammer technology
- Swivelling connector
- Handle exhaust

Specifications:

- speed: 5,500rpm
- drive: 1"
- max. torque: 2,034Nm
- working torque range: 271-1,627Nm
- connector: 3/8"
- average consumption: 198l/min
- recommended supply pressure: 6.2bar
- length: 228mm
- weight: 5kg

OP1420 EXHAUST PNEUMATIC SLEEVE FOR 3/4" AND 1" IMPACT WRENCHES

Accessory of OP 1405/OP 1409

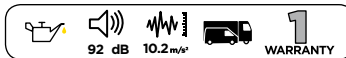

OP 1407

1" D. IMPACT WRENCH 2441Nm



- Powerful
- Horizontal work
- Anvil 210mm
- Throttle incorporated into the handle
- 3-position regulator
- Double-hammer technology
- Lateral exhaust

Specifications:

- max. torque: 2441Nm
- release torque: 2033Nm
- speed: 6,000rpm
- length: 467mm
- connection: 1/2"
- supply pressure: 6.2bar
- consumption: 282l/min
- net weight: 7.5kg

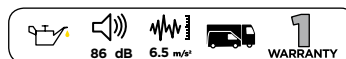

OP 1422

1" D. HGV IMPACT WRENCH 3390Nm



- Powerful
- Horizontal work
- Anvil 210mm
- Throttle incorporated into the handle
- 3-position regulator
- Double-hammer technology
- Lateral exhaust

Specifications:

- max. torque: 3390Nm
- speed: 5,000rpm
- length: 565mm
- connection: 1/2"
- supply pressure: 6.2bar
- consumption: 282l/min
- net weight: 11kg

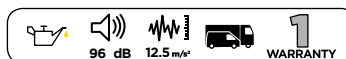

DRILLING

OP 1460

SPOT DRILL



- Quiet
- Low speed/high torque
- Orientable locking jaws
- Ergonomic handle
- Swiveling connector
- Bottom exhaust

Specifications:

- speed: 800tr/min
- for reamer: Ø6.3/8.3/10.3x47mm
- length: 349mm
- connection: 1/4"
- supply pressure: 6.2bar
- consumption: 113l/min



Connector supplied

SA 1460 CARBIDE REAMER 8.3x47mm

Spare part of OP 1460

78 dB 0.2 m/s² WARRANTY 1

- Two-speed trigger
- Automatic chuck
- Silent
- Composite housing
- Ergonomic handle + additional handle
- Swivelling connector
- Bottom exhaust with silencer
- Reversing bar on both sides
- Inversion of the rotation direction with one hand accessible from both sides

Connector supplied



OP 1450

Ø10mm REVERSIBLE DRILL

Specifications:

- motor: 0.5cv
- speed: 1800rpm
- length: 185mm
- connector: 1/4"
- supply pressure: 6.2bar
- consumption: 113l/min



OP 1451

Ø13mm REVERSIBLE DRILL

Specifications:

- motor: 0.5cv
- speed: 800rpm
- length: 218mm
- connector: 1/4"
- supply pressure: 6.2bar
- consumption: 113l/min

Drills page 43

83 dB 0.4 m/s² WARRANTY 1

OP 1218

Ø10mm REVERSIBLE ANGLE-DRILL



- Industrial key chuck 10mm
- 90° head
- Aluminum body
- Reversible
- Rear exhaust

Specifications:

- speed: 1,200rpm
- length: 203mm
- connector: 1/4"
- supply pressure: 6.2bar
- consumption: 113l/min



Connector supplied

90 dB 0.5 m/s² WARRANTY 1

OM 0649

19 PCS TITANE DRILL SET
Ø1-Ø10mm



OM 0480

PRO PLIERS FOR RIVETS & LOCKNUTS



SA1489: repair kit for riveting pliers



Suitable for:
• rivets Ø2.4-3.2-4-4.8-6.4mm
• locknuts Ø4-5-6-8-10mm

Contents:
• m4-M5-M6-M8-M10 pull spindles
• 3.2-4.0-4.8 et 6.4mm nozzles



OP 1475

AIR RIVETER KIT

Specifications:

- rivet capacity up to 4.8mm depending on the bit
- traction power: 900kg
- stroke length: 14mm
- bits: 2.4-3.2-4-4.8mm
- air inlet: 1/4"
- air pressure: 6.2bar
- consumption: 1.4 to 1.8l/min

Connector supplied

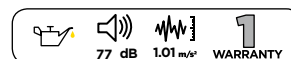

OM 0749BL

RIVETING PLIERS

B.LINE



Specifications:

- handle sheathed with return spring
- supplied with 4 nozzles Ø2.4-3.2-4.0-4.8mm
- key for nozzle assembly
- length: 270mm



CUTTING

OP 1470

10mm AIR BODY SAW



Specifications:

- strokes/min: 9500
- stroke length: 10mm
- length: 300mm
- connector: 1/4"
- supply pressure: 6.2bar
- consumption: 90l/min

- light
- composite body
- low vibration
- swiveling connector
- safety trigger
- ergonomic handle with protection

Supplied with:

- connector
- SA1470: 24-tooth blade
- SA1471: 32-tooth blade

Options:

- SA1472: set of 5 blades with 24 teeth + 5 blades with 32 teeth



SA 1471	32-TOOTH BLADE	Spare part of OP 1470
SA 1470	24-TOOTH BLADE	Spare part of OP 1470



OP 1580

VIBRO CHISEL SET

Chisel set for easier removal of corroded, seized or crimped parts.



Specifications:

- capacity: 3200bpm
- operating pressure: 6.5bar
- connector 1/4"
- consumption: 180l/min

Contents:

- SA1586: vibro chisel
- SA1580: spring
- SA1581: flat chisel 20mm
- SA1582: curved chisel (welding spots+rivets)
- SA1583: punch
- SA1584: cutting chisel
- SA1585: splitter chisel
- accessories: Ø10mm
- length of accessories plug: 43mm

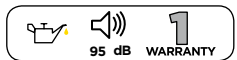

OP 1480

PNEUMATIC CHISEL TOOLS

Chisel set for an easier removal of corroded, seized or crimped parts.



Specifications:

- capacity: 2200bpm
- operating pressure: 5 to 8bar
- consumption: 114l/min
- noise level 100dB

Contents:

- SA1480: chipping/chisel hammer
- SA1481: adapter for 1/2" D. impact sockets
- SA1482: adapter for Ø38-63-74mm blocks
- SA1483: circular shaped block Ø38mm
- SA1484: rounded hollow block Ø63mm
- SA1485: circular shaped block Ø74mm
- SA1486: circular shaped block Ø25mm
- SA1487: rounded hollow block Ø25mm
- SA1488: 10pcs O-rings

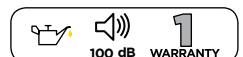

OP 0500

PNEUMATIC KNIFE



- oscillations/min: 20000
- length: 192mm
- supply pressure: 6.2bar
- consumption: 113l/min
- net weight: 1kg

Supplied with conector and 1 OP0557 blade

 90 dB
  1.6 m/s²
  1 WARRANTY



OP 1207

ANGLE CUTTER Ø75mm







Connector supplied

- powerful
- 8 adjustable protective sump positions
- speed regulator
- grip handle
- rear exhaust

Specifications:

- speed: 17,000rpm
- motor: 0.70cv
- length: 304mm
- connector: 1/4"
- supply pressure: 6.2bar
- consumption: 113l/min



 93 dB
  2.4 m/s²
  1 WARRANTY

OP 1206

ANGLE GRINDER Ø125mm







Connector supplied

- powerful
- centrifugal regulator
- Alu/composite sump
- 9 adjustable protective sump positions
- reversible auxiliary handle
- fast-change disk
- rear exhaust

Specifications:

- speed: 10,000rpm
- shank: M14
- disc: 0.8mm to 6mm
- motor: 0.75cv
- length: 238mm
- connection: 1/4"
- supply pressure: 6.2bar
- consumption: 113l/min



 89 dB
  1.2 m/s²
  1 WARRANTY

OP 1214

REVERSIBLE DISK-SANDER







Connector supplied

- powerful
- composite housing
- reversing bar on both sides
- rear exhaust with silencer

Specifications:

- speed: 16,000rpm
- plates: 75/100/125mm
- motor: 0.60cv
- length: 142mm
- connector: 3/8"
- supply pressure: 6.2bar
- consumption: 113l/min

 83 dB
  0.4 m/s²
  1 WARRANTY

GRINDER



OP 1232

PNEUMATIC MINI GRINDER SET 12PCS

Contents:

- OP1203: mini die grinder Ø6mm 25,000rpm
- OP1231: pneumatic grinder accessory set 11pcs

OP 1231 PNEUMATIC GRINDER ACCESSORY SET 11PCS

Accessory of OP 1203/OP 1204

OP 1210

MULTI-SERVICE BRUSH



- light
- safety guard
- grip handle + auxiliary handle
- use with gum or brush
- safety throttle
- rear exhaust

Specifications:

- speed: 3,500rpm
- length: 280mm
- connection: 1/4"
- supply pressure: 6,2bar
- consumption: 110l/min

Supplied with:

- connectors
- SA1210 : metal brush Ø23mm
- SA1213 : adapter for gum and brush Ø23mm



SA 1210	METAL BRUSH L.23mm	Spare part of OP 1210
SA 1211	HARD GUM Ø105mm	Accessory of OP 1210
SA 1212	SOFT GUM Ø105mm	Accessory of OP 1210
SA 1213	ADAPTER FOR GUM AND BRUSH	Spare part of OP 1210
SA 1209	WIRE BRUSH (FINE) L.23mm	Accessory of OP 1210

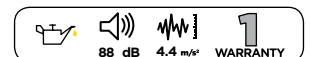



OP 1204

MINI DIE GRINDER Ø6mm 20,000rpm

- Light
- Grip handle
- Safety throttle
- Rear exhaust with silencer
- Speed regulator
- Swiveling connector

Specifications:

- speed: 20,000rpm
- length: 188mm
- connection: 1/4"
- supply pressure: 6.2bar
- consumption: 113l/min

Connector supplied



OP 1203

MINI DIE GRINDER Ø6mm 25,000rpm

- Light
- Grip handle
- Safety throttle
- Rear exhaust with silencer

Specifications:

- speed: 25,000rpm
- length: 159mm
- connection: 1/4"
- supply pressure: 6.2bar
- consumption: 113l/min



Material: aluminum oxide

Thread M6

CO 1203 50 ABRASIVE DISCS P40 Ø50mm

CO 1204 50 ABRASIVE DISCS P60 Ø50mm

CO 1205 50 ABRASIVE DISCS P80 Ø50mm

CO 1202 ABRASIVE DISC HOLDER TRAY Ø50mm

CO 1201 ABRASIVE HOLDER DISC TRAY SUPPORT AXLE Ø50mm

SA 1203 DRILLED SHAFT SUPPORT DISKS

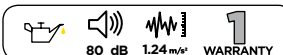

SA 1421

GUM Ø86mm

Spare part of OP 1421



OP 1205

MINI ANGLE DIE GRINDER Ø6mm



- Light
- Grip handle
- Safety throttle
- Rear exhaust with silencer
- Speed regulator
- Swiveling connector

Specifications:

- speed: 20,000rpm
- angle: 115°
- vibration: 1.24m/s²
- connection: 1/4"
- supply pressure: 6.2bar
- consumption: 113l/min

Connector supplied

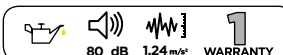

SANDER

OP 1312

2.5mm RANDOM ORBITAL PALM SANDER Ø150mm

Specifications:

- speed: 12,000rpm
- orbit: 5mm
- pad: Ø150mm
- length: 196mm

- connector: 1/4"
- supply pressure: 6.2bar
- consumption: 57l/min
- net weight: 0.7kg

- ultra-light composite body with anti-vibration belt
- speed regulator
- rear exhaust
- connection for cuff Ø32mm
- for use by hand



Black trigger:
dry air

OP 1311

5mm RANDOM ORBITAL PALM SANDER Ø150mm

Specifications:

- speed: 12,000rpm
- orbit: 5mm
- pad: Ø150mm
- length: 196mm

- connector: 1/4"
- supply pressure: 6.2bar
- consumption: 57l/min
- net weight: 0.7kg

- ultra-light composite body with anti-vibration belt
- speed regulator
- rear exhaust
- connection for cuff Ø32mm
- for use by hand

Connector supplied

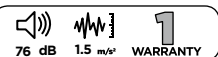

SA 1250	EXHAUST HOSE ASSEMBLY Ø32mm L170cm	Accessory of OP 1211/OP 1212/OP 1311/OP 1312/OE 1318/OE 1319
CO 1313	3 FLEXIBLE INTERFACES Ø150/10mm	Accessory of OP 1314/OP 1211/OP 1212/OP 1311/OP 1312/OP 1313/OE 1318/OE 1319
CO 1312	3 FLEXIBLE INTERFACES Ø150/5mm	Accessory of OP 1314/OP 1211/OP 1212/OP 1311/OP 1312/OP 1313/OE 1318/OE 1319
CO 1311	MEDIUM MULTI-HOLE VELCRO® TRAY Ø150mm/8mm	Accessory of OP 1314/OP 1211/OP 1212/OP 1311/OP 1312/OP 1313/OE 1319/OE 1318

OP 1445

10mm BELT SANDER



- Safety throttle
- Covered grip
- Handle exhaust + silencer
- Swiveling connector
- Safety lever

Specifications:

- speed: 18,000rpm
- belt: 10mmx330mm
- max. length: 330mm
- length folded: 207mm
- connection: 1/4"
- supply pressure: 6.2bar
- consumption: 116l/min

Connector supplied

SA 1445 SANDING STRIP 80

SA 1446 SANDING STRIP 120

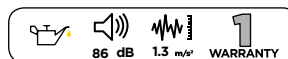

Central vacuum cleaner
page 459



OP 1213

VERTICAL POLISHER Ø150mm



- Composite body
- Auxiliary handle
- Lateral exhaust

Specifications:

- speed: 3,500rpm
- plate: Ø150mm
- length: 165mm
- connector: 1/4"
- supply pressure: 6.2bar
- consumption: 110l/min

Connector supplied

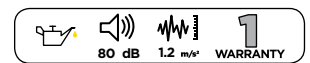
**OP 1429**

3" MINI POLISHER KIT Ø75mm

**Specifications:**

- speed: 3,200rpm
- pad size: 75mm
- spindle thread: M6x100
- air consumption: 170l/min
- length: 115mm

Connector supplied



SA 1429 Ø75mm VELCRO SANDING PAD

Spare part of OP 1428/OP 1429

OP 1428

MINI ORBITAL SANDER KIT Ø50-75mm

**Specifications:**

- speed: 15,000rpm
- pad size: 50-75mm
- length: 108mm
- spindle thread: M6x100
- air consumption: 170l/min

Connector supplied

Contents:

- connector
- SA1428: velcro sanding pad Ø50mm
- SA1429: velcro sanding pad Ø75mm
- 10 sanding discs Ø50mm P320
- 10 sanding discs Ø50mm P400
- 10 sanding discs Ø50mm P600
- 10 sanding discs Ø75mm P320
- 10 sanding discs Ø75mm P400
- 10 sanding discs Ø75mm P600



GUNS

OP 5060

PNEUMATIC GUN FOR 370mm CARTRIDGES AND BAGS



Specifications:

- aluminum body and ring
 - total length: 470mm
 - length: 370mm
 - height: 270mm
 - sound level: 80dB
 - air pressure inlet regulator from 4 to 8bar (10bar maximum) with 1/4" connection
 - valve strength: 160kgf to 8bar
 - progressive trigger to enable speed control
- Connector and plastic spout supplied



OP 5061

AIR CAULKING GUN

For the application of silicones, glues and putties with 310ml cartridges.

Specifications:

- aluminum body
 - total length: 325mm
 - 1/4" connection
 - supply pressure: 5bar
 - progressive trigger to enable speed control
- Connector supplied



OC 5071

CARTRIDGE AND BAGS GUN 340mm 12:1



For the application of silicones, adhesives and putties in 310ml cartridges and 300 and 400ml bags.

Specifications:

- aluminum handle, body and ring
- ratio: 12:1
- max. thrust: 4000Nm
- total length: 340mm

Supplied with 1 plastic spout SA5065



OC 1025**BI-COMPOSING GUN 50ml**

Allows the application of two-component adhesives in 50ml cartridges.
Delivered with piston 2:1

NEW

Consumables
p. 49

OP 1338**CARTRIDGE SPRAY GUN (POLYMER MS)**

Allows the application of sealants, seals and waterproofing adhesives sprayable with 310ml cartridges.
Spray or extrusion application.

Specifications:

- adjustable pressure and flow rate
- operating pressure: 3-5bar

Supplied with spray and extrusion nozzle

**OP 0521****PNEUMATIC GREASE GUN 450ml****Specifications:**

- nozzle length: 170mm
- capacity: 450ml
- operating pressure: 6.2bar
- weight: 1.8kg

**HU 0512****GREASE GUN 500ml**

This high pressure grease gun works at 550bar and has an improved plunger for complete grease removal for both cartridge and bulk grease loading.



PAINTING

OP 1335

HVLP PROFESSIONAL SPRAY PAINT GUN

HVLP gravity gun for bodywork and finishing work.

Specifications:

- excellent spread and spray
- reworked ergonomics to make it more comfortable to handle
- stainless steel nozzle, brushed aluminum body Ø2mm
- polyamide tub 600ml
- filter
- service pressure: 1 to 2bar

SA 1312	Ø1.2mm NOZZLE	Accessory of OP 1335
SA 1314	Ø1.4mm NOZZLE	Accessory of OP 1335
SA 1316	Ø1.6mm NOZZLE	Accessory of OP 1335
SA 1320	Ø2mm NOZZLE	Spare part of OP 1335



Connector and Ø2mm nozzle supplied



OP 1336

MINI PROFESSIONAL SPRAY GUN HVLP

HVLP gravity gun for retouching and finishing.

Specifications:

- excellent spread and spray
- ergonomic, easy to hold
- Ø0.8mm nozzle
- filter
- service pressure: 1 to 2bar



Connector and Ø0,8mm nozzle supplied



OP 3501

DRYING GUN

Specifications:

- compressed air venturi system
- airflow regulator
- max. flow 6bar
- consumption 350l/min
- noise level in dB: 72dB at 3.5bar
- service pressure 2 to 4bar
- dust filters



OP 3510

2 DRYING GUNS + BASES



OP 3520

4 DRYING GUNS + 2 BASES

Specifications:

- ideal for drying tops and bottoms of vehicles
- fully adjustable base max. 2.08m
- power supply via spiral hose
- fast connectors
- 2 guns can be up to 0.85m apart



BLASTING

OP 0618

MICROGRAIN PNEUMATIC SANDBLASTING BOOTH



Specifications:

- glazed access hatch
 - hatch protective film
 - neon interior light
 - reinforced rubber handing gloves
 - compatible with abrasives: microbead glass, corindon, shot, plastic media
 - gun supplied with 4 ceramic nozzles
- External dimensions: L.625xH.490xD.490mm
Internal dimensions: L.490xH.395xD.290mm

Spare parts:

- SA6615: drum of synthetic sand 30kg
- SA0640: gun
- SA0641: ceramic nozzle
- SA0642: glove clamp
- SA0643: gloves
- SA0644: plexiglass for trapdoor
- SA0645: air filter



OP 0615

HIGH-FLOW SANDING GUN (ceramic nozzle)



Specifications:

- extraction hose 3m
- service pressure: 6 to 8bar
- air consumption: 500L/min
- to be used with sand drum SA6615

SA 6616 CERAMIC NOZZLE Spare part of OP 0615

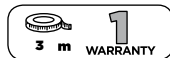

OP 0617

HIGH-FLOW SANDING GUN (metal nozzle)



Specifications:

- air consumption : 750L/min
- working pressure : 8bar
- hose length : 1.2m

SA0617: Metal nozzle



OP 0048

GLASS ENGRAVING CASE



Contents:

- storage unit with compartments for letters and numbers
- SA6807: stencil kit (letters and numbers 5.2mm)
- SA6804: engraving die for letters or numbers
- SA6805: engraving gun
- SA6803 : filter for engraving gun
- SA6806: container of abrasive sand 1kg

Options:

- SA6808: replacement nozzle
- SA6811: foam disc for the replacement nozzle



CLEANING

OP 1481

SANDBLASTING GUN

For projection of soundproofing products, sealants and anti-rust.



Specifications:

- nozzle Ø: 6mm
- working pressure: 8bar max.
- air consumption: 100 to 150l/min



OP 0044

PRO SPRAY GUN



Specifications:

- 2 adjustable jets and air flow
- nozzle L.300mm Ø2mm
- connector 1/4"
- service pressure: 2 to 8bar



OP 0022

CLEANING GUN



Connector supplied

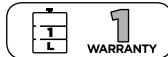

OP 0024

CLEANING GUN EVOLUTION



Specifications:

- nozzle rotating speed 4000-8000rpm
- operating pressure 5 to 8 bars
- consumption 180L/min
- bowl capacity 1L
- connector supplied

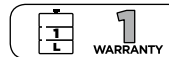

OC 1515

PRESSURE FOAM SPRAYER 11l

Foam diffuser

Specifications:

- viton seals
- adjustable nozzle
- capacity: 11.2l
- scale: 1l-0.5Gal
- handle with integrated strainer
- hose L.2m
- lance 110° hose L.57cm
- pressure gauge 0-12bar
- pneumatic pressure connection
- max. pressure: 3bar
- side relief valve
- expanded base with consumable storage compartment

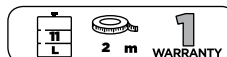

OC 1516

PRESSURE SPRAYER 11l

Specifications:

- viton seals
- adjustable nozzle
- capacity: 11.2l
- scale: 1l-0.5Gal
- handle with integrated strainer
- hose L.2m
- lance 110° hose L.60cm
- pressure gauge 0-12bar
- pneumatic pressure connection
- max. pressure: 3bar
- side relief valve
- expanded base with consumable storage compartment

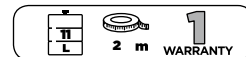



HANDTOOLS

STORAGE

EG 0061

METAL TOOLBOX 3 STOREY/6 COMPARTMENT

Made in France



Allows to organize in all simplicity.
Light weight: easy to transport
Robust: protected tools
Folding in accordion: maximum opening



Specifications:

6 compartments:
• 2 x L.210xW.97xH.97xH.44mm
• 3 x L.425xW.97xH.44mm
• 1 x L.425xW.198xH.104mm
Padlock locking device
2 handles Ø14mm
Folding accordion type
Anti-tipping device
Dimensions: L.450xW 206xH 222mm

2
WARRANTY

EG 0097**4 DRAWERS + 1 DOOR ROLLER CABINET HGV**

Drawer "Made in France" specially designed for the most demanding workshops. Wide and sturdy, it offers a larger work surface and a total load capacity of 900kg. Perforated on both sides, the drawer is fully accessorizable (workshop bin, hand towel dispenser, etc...)

Its side lock located under the handle protects the key during handling.



Made in France

**Specifications:**

- dimensions: L.989xW.450xH.983mm (height without wheels 831mm)
- 100% drawer opening
- 4 drawers H.75mm inside 774x440mm
- 1 door H.386mm
- aluminium plate
- slides equipped with ball bearings
- ABS drawer handles
- side lock
- key lock (2 keys provided)
- wheels on sealed bearing
- 2 fixed wheels Ø125mm
- 2 steering castors Ø125mm which 1 with double brake (rotation + pivot)
- permissible load per drawer: 45kg
- total load-carrying capacity: 900kg

Supplied with compartmentalized tray made of ABS, resistant to hydrocarbons
Customizable color possible (contact us)

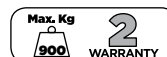

EG 0090**7 DRAWERS XL ROLLER CABINET**

Drawer "Made in France" specially designed for the most demanding workshops. Wide and sturdy, it offers a larger work surface and a total load capacity of 900kg. Perforated on both sides, the drawer is fully accessorizable (workshop bin, hand towel dispenser, etc...) Its side lock located under the handle protects the key during handling.



—
Made in France
—

**Specifications:**

- dimensions: L.810xW.455xH.984mm (height without wheels 833mm)
- 100% drawer opening
- 5 drawers H.75mm inside 584x398mm
- 2 drawers H.151mm inside 580x398mm
- slides equipped with ball bearings
- ABS drawer handles
- side lock
- key lock (2 keys provided)
- wheels on sealed bearing
- 2 fixed wheels Ø125mm
- 2 steering castors Ø125mm which 1 with double brake (rotation + pivot)
- permissible load per drawer: 45kg
- total load-carrying capacity: 900kg

Supplied with compartmentalized tray made of ABS, resistant to hydrocarbons.
Customizable color possible (contact us).

EG 0091 METAL TRAY 662x340mm



EG 0087

7 DRAWERS ROLLER CABINET

Drawers open fully



Supplied with a wooden plate and EVA foam



Specifications:

- overall dimensions: 688x459x1035mm (height without wheels 858mm)
- 5x75mm high drawers (580x400x61mm)
- 2 drawers H.154mm (580x400x141mm)
- full extension ball bearing slides
- lockable drawers
- aBS drawer handles
- 2 fixed casters Ø125mm
- 2 swiveling casters with side brakes Ø125mm
- locks with a key (2 keys provided)
- 2.5mm of EVA foam in each drawer
- permissible load in each drawer: 45kg
- permissible load on the tray: 300kg
- total permissible load: 400kg



EG 0083**3 TRAY ROLLER CABINET****Specifications:**

- overall dimensions: 766x415x840mm
- tray dimensions: 760x410x60mm
- 2 fixed casters Ø100mm
- 2 swiveling casters Ø100mm with brakes
- 2.5mm thick EVA foam tray protection
- admissible load per shelf: 90kg
- total admissible load: 270kg

**EG 0086****3 DRAWER/1 DOOR ROLLER CABINET**

Drawers open fully

**Specifications:**

- overall dimensions: 688x459x858mm
- 2x75mm drawers (580x400x61mm)
- 1x154mm high drawer (580x400x141mm)
- 1 door (604x395mm)
- drawers guided by sliding ball bearings
- 2 fixed casters Ø125mm
- 2 swiveling casters with side brakes Ø125mm
- 3pcs 2.5mm thick EVA foam drawer liners
- 1pc 10mm thick EVA top mat
- admissible load per drawer: 45kg
- admissible load on tray: 120kg
- total admissible load: 360kg
- Key-locking (2 keys)



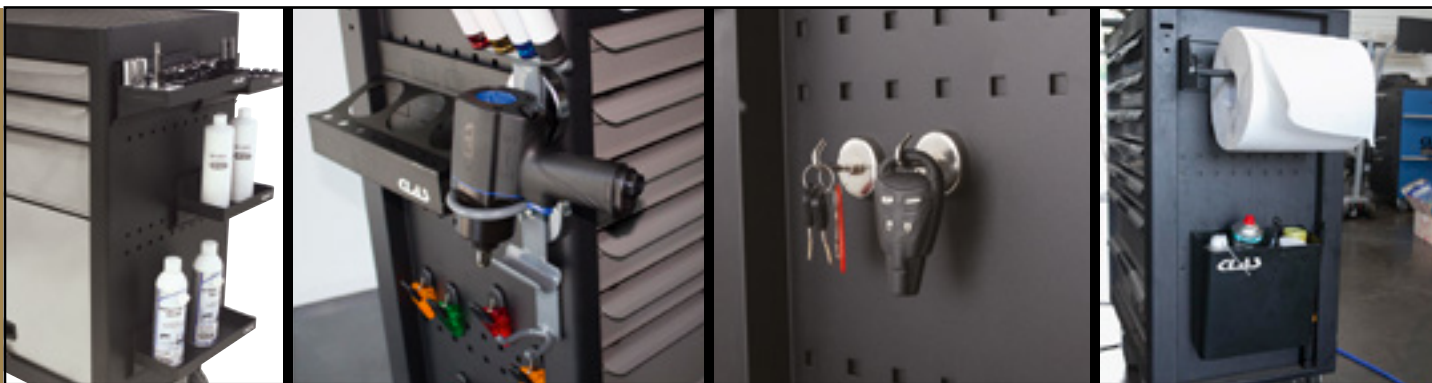

MAGNETIC!



EG 8007

MAGNETIC TRAY

Ideal for stocking small mechanical parts, screws, tools...
Rubber protection covering its strong magnets prevent surfaces from becoming scratched.

Specifications:

- ABS tray
- Ø148mm
- h.112mm
- 2 magnets Ø80mm



EG 8006

MAGNETIC SPRAY CAN AND SCREWDRIVER HOLDER

With strong magnets to firmly stick on metal tool boxes, this holder is made to hold 3 spray cans and 7 screwdrivers.
This holder is designed to allows the users creating new storage areas.



EG 8004

4PCS MAGNETIC TOOL TRAY SET

These 4 storage trays are designed to firmly stick onto metal workshop trolleys, lifting bridges or any other metallic surfaces in order to create additional storage space.
Strong batteries ensure robust fixing.

Contents:

- 1 tray 310x110x120mm, load capacity 1.17kg
- 1 tray 270x110x120mm, load capacity 1kg
- 1 tray 210x110x120mm, load capacity 0.77kg
- 1 tray 150x110x120mm, load capacity 0.6kg



EG 8008

20 MAGNETIC HOOKS SET

These magnetic hooks are designed to help users to keep their frequently used tools in one place for easy handling.

Max. load: 800gr per hook



EG 0070

MAGNETIC TOOL HOLDER

Weight: 1.35kg



EG 8001

METAL WORKSHOP WASTE FOR DRAWER

Accessory of EG 0086/EG 0087/EG 0090/EG 0090ALF/
EG 0090ALP/EG 0090LTS/EG 0084/EG 0085

This workshop waste bin is designed to affix onto workshop trolleys, quickly and with no use of tools required. The operator will always have it to hand, meaning the trolley tray will not get dirty or cluttered. Easy to wash, so no bag is required.



Specifications :

- capacity: 7L
- width: 265mm
- height: 250mm
- depth: 125mm



EG 8009

DISPENSER/HAND TOWEL ROLL STAND FOR DRAWERS

Accessory of EG 0086/EG 0087/EG 0090/EG
0090ALF/EG 0090ALP/EG 0090LTS/EG 0084/EG 0085

This dispenser/stand for hand towels is designed to affix onto workshop trolleys, quickly and with no use of tools required. Operators will always have a roll to hand.



Capacity: Rolls up to Ø250mm and L.310mm



OS 0080

INSERT CASE FORMAT 1/3 DRAWER

Accessory of OS 1000/OS 1100/OS 2000/OS 2100/OS 3000/OS 3200/
OS 3600/OS 4000/OS 4100/OS 4200/OS 5000/OS 5100/EG 0080

Case specially designed to accommodate 1/3 hand tool inserts. Ideal for intervention/repair with all or part of the servant or to store additional inserts outside the drawers.



Internal dimensions:
395x190x62mm



EG 0344

BAG OF 10 DOUBLE HOOKS Ø6mm L.50mm



EG 0346

BAG OF 10 SIMPLE HOOKS Ø6mm L.50mm



EG 0347

BAG OF 10 DOUBLE HOOKS Ø6mm L.100mm

Ø hook: 6mm
Hook length: 50mm
Tip 45°
Squared perforated panel fixing 10x10mm (38mm gap)



EG 0080

FOAM STORAGE TRAY

Accessory of EG 0083/EG 0086/EG 0087/EG 0090/EG
0090ALF/EG 0090ALP/EG 0090LTS/EG 0084/EG 0085

External dimensions: 390x185x54mm
Internal dimensions: 320x140x43mm





CONTENTS & INSERTS

EG 0065

METAL TOOLBOX 101 PCS



Contents:

- EG0061: metal toolbox 3 storey/6 compartment
- OS3000: 23 piece 1/2" ratchet insert
- OS3220: 9 piece spherical hex key set h1,5-10
- OS3230: 32 piece screwdriver bit 1/4" set
- OS4101 to OS 4117: combination wrenches 6-24mm
- OS5099: 4 pliers set
- OS1099: 8 piece screwdriver set
- OM0125: forged steel hammer 1250g
- OM0801: 6 pin driver set with base
- OM8088: magnetic pick up tool ø5mm l.525mm





OS 4100



OS 5200



OS 5000



OS 1000



OS 3000



OS 3200

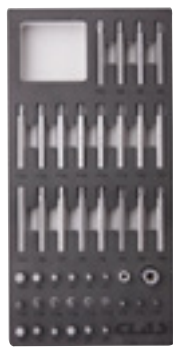

OS 6000



OS 1100



OS 2000



OS 3052



OM 0640

TROLLEY 3 DRAWERS COMPOSITION



EG 0086

COMPOSITION	EG 1184	EG 1185	EG 1203
NB TOOLS	119 tools	185 tools	203 tools
EG 0086 - 3 DRAWER/1 DOOR ROLLER CABINET	•	•	•
OS 3052 - 94 D. SOCKET SET 1/4"-1/2"	•		
OS 4100 - 17 PCS COMBINATION WRENCH INSERT 6-24mm	•	•	•
OS 5200 - 4PCS CIRCLIP PLIER INSERT 7" INSIDE-OUTSIDE	•		•
OS 5000 - 4 PCS PLIER INSERT	•	•	•
OS 1000 - 8 PCS SCREWDRIVER INSERT		•	•
OS 3000 - 23 PCS 1/2" RATCHET INSERT		•	•
OS 3200 - 59 PCS RATCHET INSERT 1/4"		•	•
OS 6000 - 43 PCS SPECIAL BIT INSERT		•	•
OM 0640 - 33 PRECISION SCREWDRIVER + BIT SET		•	•
OS 1100 - 7 PCS TORX SCREWDRIVER INSERT T10-40			•
OS 2000 - 7 PCS HEX T-HANDLE WRENCH INSERT 3-10mm			•



TROLLEY 7 DRAWERS COMPOSITION



OS 4100



OS 5200



OS 5000



OS 1000



OS 3000



OS 3200

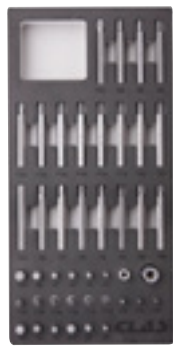

OS 6000



OS 1100



OS 2000



OM 0640



COMPOSITION	EG 2185	EG 2203
NB Tools	185 tools	203 tools
EG 0087 - SERVANTE 7 TIROIRS	•	•
OS 1000 - 8 PCS SCREWDRIVER INSERT	•	•
OS 4100 - 17 PCS COMBINATION WRENCH INSERT 6-24mm	•	•
OS 3000 - 23 PCS 1/2" RATCHET INSERT	•	•
OS 3200 - 59 PCS RATCHET INSERT 1/4"	•	•
OS 5000 - 4 PCS PLIER INSERT	•	•
OS 6000 - 43 PCS SPECIAL BIT INSERT	•	•
OM 0640 - 33 PRECISION SCREWDRIVER + BIT SET	•	•
OS 1100 - 7 PCS TORX SCREWDRIVER INSERT T10-40		•
OS 2000 - 7 PCS HEX T-HANDLE WRENCH INSERT 3-10mm		•
OS 5200 - 4PCS CIRCLIP PLIER INSERT 7" INSIDE-OUTSIDE		•



EG 3228

7 DRAWERS ROLLER CABINET XL 228 TOOLS



OS 1000 OS 1100 OS 2000



OS 5200 OS 5000 OS 2100



OS 3000 OS 3200 OS 6000



EG 0080 OS 4399 OM 0640



OS 4200 OS 4100



Contents:

- EG0090 : 7 drawers roller cabinet XL
- OS1000: 8 piece screwdriver insert
- OS1100: 7 piece Torx screwdriver insert T10-40
- OS2000: 7 piece hex t-handle wrench insert 3-10mm
- OS2100: 7 piece Torx t-handle wrench insert T10-T40
- OS3000: 23 piece ratchet insert 1/2"
- OS3200: 57 piece ratchet insert 1/4"
- OS4100: 17 piece combination wrench insert 6-24mm
- OS4200: 4 piece combination wrench insert 27-32mm
- OS4399: set of 12 hex socket spanners
- EG0080: foam storage tray
- OS5000: 4 piece plier insert
- OS5100: 4 internal/external circlip plier insert
- OS6000 : 43 piece special bit insert
- OM0640: 33 precision screwdriver + bit set



EG 4197

4 DRAWERS + 1 DOOR ROLLER CABINET HGV 197 TOOLS



OS 1000

OS 1100

OS 2000



OS 6000



OS 3000



OS 3200



OS 4100



OS 5000



OS 4499



EG 0080



OS 4399



OS 4200



OS 5105



Contents:

- EG0097: 4 drawers + 1 door roller cabinet HGV
- OS1000: 8 piece screwdriver insert
- OS1100: 7 piece Torx screwdriver insert T10-40
- OS2000: 7 piece hex t-handle wrench insert 3-10mm
- OS3000: 23 piece ratchet insert 1/2"
- OS3200: 57 piece ratchet insert 1/4"
- OS4100: 17 piece combination wrench insert 6-24mm
- OS4200: 4 piece combination wrench insert 27-32mm
- OS4399: set of 12 hex socket spanners
- OS4499: set of 6 hex socket spanners
- EG0080: 2 foam storage trays
- OS5000: 4 piece plier insert
- OS5105: internal/external circlips pliers
- OS6000: 43 piece special bit insert





RATCHETS

1/4"

6.3

HEX SOCKETS



SIZE	SHORT	LONG	REF	PRICE
4mm		•	OS 3259	
4.5mm		•	OS 3260	
5mm		•	OS 3261	
5.5mm	•		OS 3201	
6mm	•		OS 3202	
		•	OS 3262	
7mm	•		OS 3203	
		•	OS 3263	
8mm	•		OS 3204	
		•	OS 3264	
9mm	•		OS 3205	
		•	OS 3265	
10mm	•		OS 3206	
		•	OS 3266	
11mm	•		OS 3207	
		•	OS 3267	
12mm	•		OS 3208	
		•	OS 3268	
13mm	•		OS 3209	
		•	OS 3269	
14mm	•		OS 3210	

TORX+ SOCKETS



SIZE	SHORT	LONG	REF	PRICE
EP6	•		SA 7086	
EP7	•		SA 7087	
EP8	•		SA 7088	
EP10	•		SA 7089	
EP11	•		SA 7090	
EP12	•		SA 7091	

OM 7019

1/4" TORX PLUS SOCKETS EP 6-7-8-10-11-12 L.25mm



Nissan, Renault, cylinder head...
Not compatible with Torx Classique indentations

Torx Plus = improved grip/reduced wear to the indentation

Contents:

- SA7086: socket torx plus EP6
- SA7087: socket torx plus EP7
- SA7088: socket torx plus EP8
- SA7089: socket torx plus EP10
- SA7090: socket torx plus EP11
- SA7091: socket torx plus EP12



TS SOCKET BITS



SIZE	SHORT	LONG	REF	PRICE
TS10	37mm		SA 0459	
TS15	37mm		SA 0460	
TS20	37mm		SA 0461	
TS25	37mm		SA 0462	
TS27	37mm		SA 0463	
TS30	37mm		SA 0464	
TS40	37mm		SA 0465	
TS45	37mm		SA 0432	
TS50	37mm		SA 0433	



OS 3258 1/4" L-HANDLE

Spare part of OS 3250

OM 7006

SET 7 SOCKETS TS TIPS 1/4" D. TS10-TS15-TS20-TS25-TS27-TS30-TS40



These 5 star bits are for brands: Renault, Peugeot, Mercedes, Rover and diesel injection pumps.





OS 3200

59 PCS RATCHET INSERT 1/4"



Format: 1/3 drawer

Contents:

- 10 hex sockets: 5.5, 6, 7, 8, 9, 10, 11, 12, 13, 14mm
- 9 hex ball wrenches: H1.5, H2, H2.5, H3, H4, H5, H6, H8, H10
- 30 screwing bits + adapter bit socket holder 1/4" :
 Pozidrive: PZ1, PZ2 (x2), PZ3
 Phillips: PH1, PH2 (x2), PH3
 Slotted: 3, 4, 5, 6
 Hexagonal: H3, H4, H5, H6
 Torx: T10, T15, T20, T25, T27, T30, T40
 Torx tamper: T10, T15, T20, T25, T27, T30, T40
 Male hex. adapter 1/4"- 1/4" square
- 1 bit holder adaptor 1/4"
- 1 ratchet 1/4" 72 teeth
- 2 extensions 50mm and 150mm 1/4"
- 1 flexible extension
- 1 CV joint 1/4"
- 1 sliding handle 1/4"
- 1 screwdriver bit holder 1/4"

Insert dimensions: 390x185x50mm
DIN ISO 2725-3

Socket retail
p. 107

OS 3254	BIT HOLDER ADAPTOR 1/4" FOR SCREWERS
OS 3255	HEX MALE ADAPTOR 1/4"-1/4" SQUARE L.25mm
OS 3256	SOCKET HOLDER SCREWDRIVER 1/4"
OS 3211	1/4" RATCHET 72 TEETH
OS 3212	1/4" EXTENSION L.50mm
OS 3213	1/4" EXTENSION L.150mm
OS 3214	1/4" FLEXIBLE EXTENSION
OS 3215	CV JOINT 1/4"
OS 3216	1/4" SLIDING T HANDLE
OS 3217	1/4" RATCHET REPAIR KIT 72 TEETH

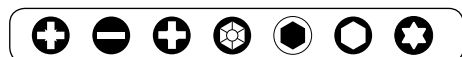

OS 3220

9 PCS SPHERICAL HEX KEY SET H1,5-10

Spare part of OS 3200



Material: SVCM steel

Contents:

- OS3221: spherical hex key H1.5
- OS3222: spherical hex key H2
- OS3223: spherical hex key H2.5
- OS3224: spherical hex key H3
- OS3225: spherical hex key H4
- OS3226: spherical hex key H5
- OS3227: spherical hex key H6
- OS3228: spherical hex key H8
- OS3229: spherical hex key H10



OS 3230

32 PCS SCREWDRIVER BIT 1/4" SET

Spare part of OS 3200



Contents:

- 30 screwdriver bits:
 Pozidrive: PZ1, PZ2 (x2), PZ3
 Phillips: PH1, PH2 (x2), PH3
 Slotted: 3, 4, 5, 6
 Hexagonal: H3, H4, H5, H6
 Torx: T10, T15, T20, T25, T27, T30, T40
 Torx tamper: T10, T15, T20, T25, T27, T30, T40
- 1 magnetic socket bit holder 1/4"
- 1 bit holder adaptor for screwers





OS 3250

59 D. SOCKET SET 1/4"

Contents 1/4":

- 13 hex sockets 1/4": 4, 4.5, 5, 5.5, 6, 7, 8, 9, 10, 11, 12, 13, 14mm
- 8 long hex sockets 1/4": 6, 7, 8, 9, 10, 11, 12, 13mm
- 27 socket bits 1/4"
 - Phillips: PH1, PH2, PH3
 - Pozidrive: PZ1, PZ2, PZ3
 - Flat: 4, 5.5, 7
 - Hexagonal: H3, H4, H5, H6, H7, H8
 - Torx: T10, T15, T20, T25, T27, T30, T40
 - 12 splines: M4, M5, M6, M8, M10
- 4 hex wrenches: H1.27, 1.5, H2, H2.5
- 1 ratchet 1/4"
- 3 extensions 1/4" L.50, 100 and 150mm
- 1 CV joint 1/4"
- 1 sliding handle 1/4"
- 1 hinge wrench 1/4"

DIN ISO 2725-3



OM 0645

23 PCS BIT SET TS-TORX-TORX PLUS 1/4"-3/8"



Torx Plus = improved grip and reduced wear to the indentation

- SA 0647: contents Torx Plus 10-15-20-25-30 hexagonal drive 1/4"
- SA 0648: Torx Plus bit set EP40-45-50-55-60 hexagonal drive 10mm
- SA 0649: TS Plus bit set EP10-15-20-25-30 hexagonal drive 1/4"
- SA 0651: TS Plus bit set EP40-45-50-55-60 hexagonal drive 10mm
- magnetic bit holder
- 1/4" and 3/8" adapters

Not compatible with Torx Classic indentations



OM 0047

1/2"D. x 3/8"D. REDUCER



OS 3620

3/8"x1/2" INCREASER

Spare part of OS 3600



3/8"

10



OS 3300

8 IMPACT SOCKET KIT 10-19mm 3/8"



DIN ISO 2725-3

OS 3301	3/8" HEX IMPACT SOCKET 10mm
OS 3302	3/8" HEX IMPACT SOCKET 11mm
OS 3303	3/8" HEX IMPACT SOCKET 12mm
OS 3304	3/8" HEX IMPACT SOCKET 13mm

OS 3305	3/8" HEX IMPACT SOCKET 14mm
OS 3306	3/8" HEX IMPACT SOCKET 15mm
OS 3307	3/8" HEX IMPACT SOCKET 17mm
OS 3308	3/8" HEX IMPACT SOCKET 19mm



OS 3600

3/8" RATCHET INSERT 21 PCS

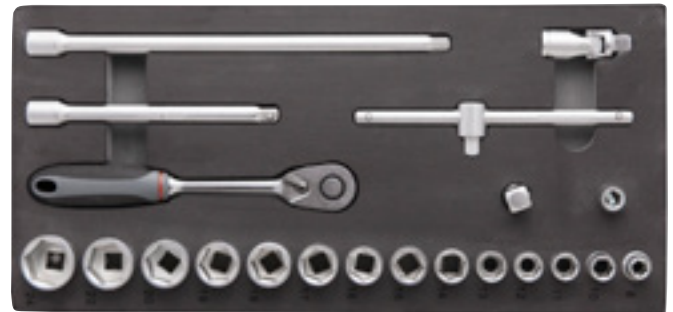

Insert dimensions: 390x185x50mm

OS 3601	3/8" HEX SOCKET 8mm
OS 3602	3/8" HEX SOCKET 10mm
OS 3603	3/8" HEX SOCKET 11mm
OS 3604	3/8" HEX SOCKET 12mm
OS 3605	3/8" HEX SOCKET 13mm
OS 3606	3/8" HEX SOCKET 14mm
OS 3607	3/8" HEX SOCKET 15mm
OS 3608	3/8" HEX SOCKET 16mm
OS 3609	3/8" HEX SOCKET 17mm
OS 3610	3/8" HEX SOCKET 18mm
OS 3611	3/8" HEX SOCKET 19mm
OS 3612	3/8" HEX SOCKET 20mm
OS 3613	3/8" HEX SOCKET 22mm
OS 3614	3/8" HEX SOCKET 24mm
OS 3615	3/8" RATCHET 72 TEETH
OS 3616	3/8" EXTENSION 150mm
OS 3617	3/8" EXTENSION 250mm
OS 3618	CV JOINT 3/8"
OS 3619	3/8" SLIDING T-HANDLE
OS 3620	3/8"x1/2" INCREASER

Format: 1/3 drawer

Contents:

- 14 hexagonal sockets: 8, 10, 11, 12, 13, 14, 15, 16, 17, 18, 19, 20, 22, 24mm
- ratchet 3/8" 72 teeth
- 2 extensions 150 and 250mm
- cV joint 3/8"
- sliding handle 3/8"
- 3/8"x1/2" increaser
- 10mm bit holder



1/2"

12,5

HEX SOCKETS



SIZE	SHORT	LONG	REF	PRICE
8mm	•		OS 3001	
10mm	•		OS 3002	
11mm	•		OS 3003	
12mm	•		OS 3004	
13mm	•		OS 3005	
14mm	•		OS 3006	
15mm	•		OS 3007	
16mm	•		OS 3008	
17mm	•		OS 3009	
18mm	•		OS 3010	
19mm	•		OS 3011	
21mm	•		OS 3012	
22mm	•		OS 3013	
23mm	•		OS 3014	
24mm	•		OS 3015	
27mm	•		OS 3016	
30mm	•		OS 3017	
32mm	•		OS 3018	

TORX SOCKETS



SIZE	SHORT	LONG	REF	PRICE
E10	•		OS 3031	
E11	•		OS 3032	
E12	•		OS 3033	
E14	•		OS 3034	
E16	•		OS 3035	
E18	•		OS 3036	
E20	•		OS 3037	
E22	•		OS 3038	
E24	•		OS 3039	



COFFRET

OM 7013

TORX SOCKETS+



SIZE	SHORT	LONG	REF	PRICE
EP10	•		SA 7080	
EP12	•		SA 7081	
EP14	•		SA 7082	
EP16	•		SA 7083	
EP18	•		SA 7084	
EP20	•		SA 7085	



COFFRET

OM 7017

IMPACT HEX SOCKETS



SIZE	SHORT	LONG	REF	PRICE
10mm	•		OS 3101	
		•	OS 3131	
11mm	•		OS 3102	
		•	OS 3132	
12mm		•	OS 3133	
13mm	•		OS 3103	
		•	OS 3134	
14mm	•		OS 3104	
		•	OS 3135	
16mm		•	OS 3136	
17mm	•		OS 3105	
		•	OS 3137	
19mm	•		OS 3106	
		•	OS 3138	
21mm	•		OS 3107	
		•	OS 3139	
22mm	•		OS 3108	
		•	OS 3140	
24mm	•		OS 3109	
		•	OS 3141	
27mm	•		OS 3110	
		•	OS 3142	
30mm		•	OS 3143	

Coffrets : voir pages suivantes

IMPACT HEX SOCKET BITS



SIZE	SHORT	LONG	REF	PRICE
10mm			SA 0488	
11mm			SA 0489	
12mm			SA 0490	
13mm			SA 0491	
14mm			SA 0492	
15mm			SA 0493	
16mm			SA 0494	
17mm			SA 0495	
19mm			SA 0496	
21mm			SA 0497	
22mm			SA 0498	
24mm			SA 0499	

Coffret : voir pages suivantes

TORX IMPACT SOCKETS



SIZE	SHORT	LONG	REF	PRICE
E10		•	OS 3111	
E11		•	OS 3112	
E12		•	OS 3113	
E14		•	OS 3114	
E16		•	OS 3115	
E18		•	OS 3116	
E20		•	OS 3117	
E22		•	OS 3118	
E24		•	OS 3119	



COFFRET

OM 7047

OS 3052

94 D. SOCKET SET 1/4"-1/2"

NEW



DIN ISO 2725-3

Contents 1/4":

- 13 hex sockets 1/4": 4, 4.5, 5, 5.5, 6, 7, 8, 9, 10, 11, 12, 13, 14mm
- 8 long hex sockets 1/4": 6, 7, 8, 9, 10, 11, 12, 13mm
- 18 socket bits 1/4":
Phillips: PH1, PH2
Pozidrive: PZ1, PZ2
Slotted: 4, 5.5, 6.5
Hexagonal: H3, H4, H5, H6
Torx: T8, T10, T15, T20, T25, T27, T30
- 1 bit holder screwdriver 1/4"
- 1 ratchet 1/4" 72 teeth
- 2 extensions 1/4" L.50 and 100mm
- 1 CJ joint 1/4"
- 1 sliding handle 1/4"

Contents 1/2":

- 17 hex sockets 1/2": 10, 11, 12, 13, 14, 15, 16, 17, 18, 19, 20, 21, 22, 24, 27, 30, 32mm
- 5 long hex sockets 1/2": 14, 15, 17, 19, 22mm
- 16 bits + 1 bit holder socket drive 1/2":
Phillips: PH3, PH4
Pozidrive: PZ3, PZ4
Slotted: 8, 10, 12
Hexagonal: H7, H8, H10, H12, H14
Torx: T40, T45, T50, T55
- 2 spark sockets 1/2": 16, 22mm
- 1 ratchet 1/2" 72 teeth
- 2 extensions 1/2" L.125 et 250mm
- 1 CV joint 1/2"
- 1 sliding handle 1/2"
- 3 hex wrenches: H1.5, H2, H2.5



OS 3050 94 D. SOCKET SET 1/4"-1/2"

OS 3051 PRE-CUT FOAM INSERT 1 TABLE DRAWER FORMAT



OM 7017

1/2" TORX PLUS SOCKETS EP 10-12-14-16-18-20 L.37mm

Torx Plus = improved grip and reduced wear to the indentation



Contents:

- SA7080: socket torx plus EP10
- SA7081: socket torx plus EP12
- SA7082: socket torx plus EP14
- SA7083: socket torx plus EP16
- SA7084: socket torx plus EP18
- SA7085: socket torx plus EP20

Not compatible with Torx Classic indentations



OM 7013

TORX "E" SOCKET SET 1/2" D. E10-E11-E12-E14-E16-E18-E20-E22-E24

Contents:

- OS3031: torx socket E10
- OS3032: torx socket E11
- OS3033: torx socket E12
- OS3034: torx socket E14
- OS3035: torx socket E16
- OS3036: torx socket E18
- OS3037: torx socket E20
- OS3038: torx socket E22
- OS3039: torx socket E24



OM 7047

IMPACT SOCKETS SET 1/2" D. L.76mm
E10-E11-E12-E14-E16-E18-E20-E22-E24



Contents:

- OS3111: torx impact socket E10
- OS3112: torx impact socket E11
- OS3113: torx impact socket E12
- OS3114: torx impact socket E14
- OS3115: torx impact socket E16
- OS3116: torx impact socket E18
- OS3117: torx impact socket E20
- OS3118: torx impact socket E22
- OS3119: torx impact socket E24



OS 3130

13 LONG HEX IMPACT SOCKET KIT 10-30mm 1/2"



DIN ISO 2725-3

Contents:

- OS3131: long hex impact socket 10mm 1/2"
- OS3132: long hex impact socket 11mm 1/2"
- OS3133: long hex impact socket 12mm 1/2"
- OS3134: long hex impact socket 13mm 1/2"
- OS3135: long hex impact socket 14mm 1/2"
- OS3136: long hex impact socket 16mm 1/2"
- OS3137: long hex impact socket 17mm 1/2"
- OS3138: long hex impact socket 19mm 1/2"
- OS3139: long hex impact socket 21mm 1/2"
- OS3140: long hex impact socket 22mm 1/2"
- OS3141: long hex impact socket 24mm 1/2"
- OS3142: long hex impact socket 27mm 1/2"
- OS3143: long hex impact socket 30mm 1/2"



OS 3100

10 IMPACT SOCKET KIT 10-27mm 1/2"



DIN ISO 2725-3

Impact wrench
p.78



Contents:

- OS3101: impact socket 10mm
- OS3102: impact socket 11mm
- OS3103: impact socket 13mm
- OS3104: impact socket 14mm
- OS3105: impact socket 17mm
- OS3106: impact socket 19mm
- OS3107: impact socket 21mm
- OS3108: impact socket 22mm
- OS3109: impact socket 24mm
- OS3110: impact socket 27mm



OM 7018

1/2" D. HEX IMPACT UNIVERSAL JOINT SOCKET SET



Impact socket made of chrome-molybdenum steel for an easier access to hard-to-reach areas (max. degree 30°).

Contents:

- SA0488: socket 10mm L.69mm
- SA0489: socket 11mm L.69mm
- SA0490: socket 12mm L.69mm
- SA0491: socket 13mm L.69mm
- SA0492: socket 14mm L.69mm
- SA0493: socket 15mm L.69mm
- SA0494: socket 16mm L.69mm
- SA0495: socket 17mm L.69mm
- SA0496: socket 19mm L.72.5mm
- SA0497: socket 21mm L.72.5mm
- SA0498: socket 22mm L.72.5mm
- SA0499: socket 24mm L.72.5mm
- 1/2" D. extension, length 125mm

Complies with ISO 1174 and DIN 3121 standards.

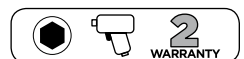



OS 3000

23 PCS 1/2" RATCHET INSERT

Format: 1/3 drawer



Contents:

- 18 hexagonal sockets: 8, 10, 11, 12, 13, 14, 15, 16, 17, 18, 19, 21, 22, 23, 24, 27, 30, 32mm
- ratchet 1/2" 72 teeth
- 2 extensions 125 and 250mm
- cV joint 1/2"
- sliding handle 1/2"



OS 3019	1/2" RACHET 72 TEETH	Spare part of OS 3000/OS 3050/OS 3055
OS 3020	1/2" EXTENSIONS 125mm	Spare part of OS 3000/OS 3050/OS 3055
OS 3021	1/2" EXTENSION 250mm	Spare part of OS 3000/OS 3050/OS 3055
OS 3022	CV JOINT 1/2"	Spare part of OS 3000/OS 3050/OS 3055
OS 3023	1/2" SLIDING T-HANDLE	Spare part of OS 3000/OS 3050
OS 3025	1/2" RATCHET REPAIR KIT 72 TEETH	Spare part of OS 3000/OS 3050/OS 3055

Insert dimensions: 390x185x50mm
DIN ISO 2725-3



OS 3024

1/2" DRIVE L. 600MM FORCE HINGED HANDLE

Maximum leverage effect

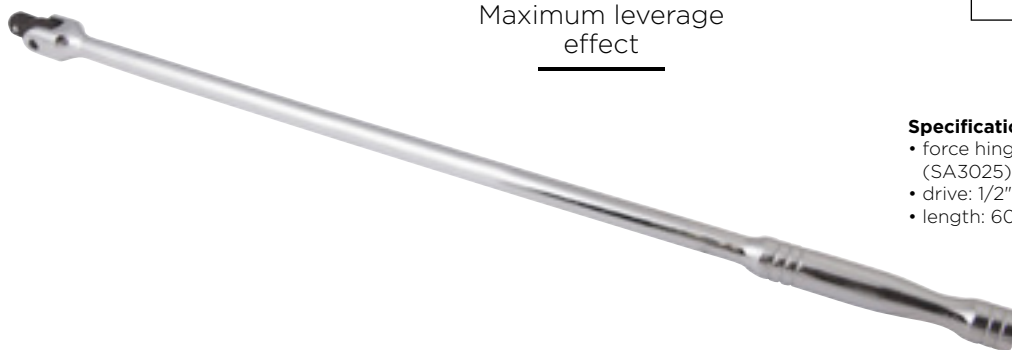

Specifications:

- force hinged handle with replaceable head (SA3025)
- drive: 1/2"
- length: 600mm



B.LINE



OM 7003BL

3 IMPACT SOCKET KIT FOR ALU RIMS



Dimensions : 17-19-21mm

3 impact sockets sheathed to avoid rim damage.



OM 7025

5 ALU WHEEL RIM 1/2" IMPACT SOCKET SET



Sheathed impact sockets to avoid rim damage, colored to enable immediate size identification. 1/2" drive.

Contents:

- SA5015: 15mm impact socket (green)
- SA5022: 17mm impact socket (blue)
- SA5017: 19mm impact socket (gold)
- SA5023: 21mm impact socket (red)
- SA5021: 22mm impact socket (purple)



SA 5025 3 PLASTIC PROTECTIONS FOR IMPACT SOCKET 1/2" 15mm

SA 5027 3 PLASTIC PROTECTIONS FOR IMPACT SOCKET 1/2" 17mm

SA 5029 3 PLASTIC PROTECTIONS FOR IMPACT SOCKET 1/2" 19mm

SA 5031 3 PLASTIC PROTECTIONS FOR IMPACT SOCKET 1/2" 21mm

SA 5032 3 PLASTIC PROTECTIONS FOR IMPACT SOCKET 1/2" 22mm

NEW

OM 7036

4 IMPACT SOCKET 1/2" KIT FOR ALU RIMS

Set including the essential sleeves for the dismantling of aluminium rims equipped with specific impression studs.



Length: 85mm

Contents:

- 15mm ultra thin specific socket SMART
- OM7016: 17mm specific socket MERCEDES/MAYBACH
- OM7026: 21mm specific socket HYUNDAI/KIA
- SA5021: 22mm specific socket OPEL



SA 0604

1/2" D. 110Nm IMPACT TORQUE EXTENSION

SA 0605

1/2" D. 120Nm IMPACT TORQUE EXTENSION

SA 0606

135Nm IMPACT TORQUE EXTENSION



Length: 195mm
Drive: 1/2"



OS 3055

1/4"-1/2" US-INCH (52 PCS)
COMPOSITION BOX SET



OS 4105	COMBINATION WRENCH 10mm	OS 4116	COMBINATION WRENCH 22mm	OS 3092	COMBINATION WRENCH 1/2"
OS 4106	COMBINATION WRENCH 11mm	OS 4117	COMBINATION WRENCH 24mm	OS 3096	COMBINATION WRENCH 11/16"
OS 4107	COMBINATION WRENCH 12mm	OS 4201	COMBINATION WRENCH 27mm	OS 3091	COMBINATION WRENCH 15/32"
OS 4108	COMBINATION WRENCH 13mm	OS 4202	COMBINATION WRENCH 29mm	OS 3094	COMBINATION WRENCH 19/32"
OS 4109	COMBINATION WRENCH 14mm	OS 4203	COMBINATION WRENCH 30mm	OS 3097	COMBINATION WRENCH 3/4"
OS 4110	COMBINATION WRENCH 15mm	OS 4204	COMBINATION WRENCH 32mm	OS 3089	1/2" COMBINATION WRENCH 3/8"
OS 4111	COMBINATION WRENCH 16mm	OS 4101	COMBINATION WRENCH 6mm	OS 3088	1/2" COMBINATION WRENCH 5/16"
OS 4112	COMBINATION WRENCH 17mm	OS 4102	COMBINATION WRENCH 7mm	OS 3095	COMBINATION WRENCH 5/8"
OS 4113	COMBINATION WRENCH 18mm	OS 4103	COMBINATION WRENCH 8mm	OS 3090	COMBINATION WRENCH 7/16"
OS 4114	COMBINATION WRENCH 19mm	OS 4104	COMBINATION WRENCH 9mm	OS 3093	COMBINATION WRENCH 9/16"
OS 4115	COMBINATION WRENCH 21mm				



OM 7069

1/2" IMPACT SOCKET BIT SET HUB AND CV JOINT

Reinforced bushings for cardans and drive shafts.
This kit is specially designed to loosen and retighten nuts and bolts with the impact wrench.



Contents:

- SA7038: socket 27mm
- SA7039: socket 30mm
- SA7042: socket 32mm
- SA7043: socket 34mm
- OM0056: socket 36mm
- SA0485: hex socket 14mm
- SA0486: hex socket 17mm
- SA0487: hex socket 19mm



OM 0024

CV JOINT WRENCH DOUBLE
HEX 1/2" D. 24mm VAG



OM 2555

LOWER BALL JOINT HEX
SOCKET PSA 41mm 1/2" D.



OM 7146

Ø 46mm SOCKET 1/2" D.
100mm



This 100mm double hex long socket can loosen and re-torque drive shaft nuts on Citroën Jumper, Peugeot Boxer, Fiat Ducato and Renault Master and Opel Movano from 2010.



1/2"

12,5



HEX SOCKET BITS

SIZE	SHORT	LONG	REF	PRICE
5mm	55mm		SA 0370	
		100mm	SA 0379	
		140mm	SA 0387	
		200mm	SA 0394	
6mm	55mm		SA 0371	
		100mm	SA 0380	
		140mm	SA 0388	
		200mm	SA 0395	
7mm	55mm		SA 0372	
		100mm	SA 0381	
		140mm	SA 0389	
		200mm	SA 0396	
		230mm	SA 0422	
8mm	55mm		SA 0373	
		100mm	SA 0382	
		140mm	SA 0390	
		200mm	SA 0397	
10mm	55mm		SA 0374	
		100mm	SA 0383	
		140mm	SA 0391	
		200mm	SA 0398	
11mm		100mm	SA 0384	
		140mm	SA 0416	
12mm	55mm		SA 0375	
		100mm	SA 0385	
		140mm	SA 0392	
		200mm	SA 0399	
13mm		100mm	SA 0386	
		140mm	SA 0417	
14mm	55mm		SA 0376	
		140mm	SA 0393	
17mm	55mm		SA 0377	
19mm	55mm		SA 0378	
22mm	55mm		SA 0403	
24mm	55mm		SA 0404	

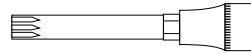

RIBE SOCKET BITS

SIZE	SHORT	LONG	REF	PRICE
M5	55mm		SA 0295	
		100mm	SA 0304	
M6	55mm		SA 0296	
		100mm	SA 0306	
M7	55mm		SA 0297	
		100mm	SA 0307	
		240mm	SA 0436	
M8	55mm		SA 0298	
		100mm	SA 0308	
		140mm	SA 0314	
		200mm	SA 0320	
		240mm	SA 0437	
M9	55mm		SA 0299	
		100mm	SA 0309	
		140mm	SA 0315	
		200mm	SA 0321	
		240mm	SA 0437	
M10	55mm		SA 0300	
		100mm	SA 0310	
		140mm	SA 0316	
		200mm	SA 0322	
M12	55mm		SA 0301	
		100mm	SA 0311	
		140mm	SA 0317	
		200mm	SA 0323	
M13	55mm		SA 0302	
		100mm	SA 0312	
		140mm	SA 0318	
		200mm	SA 0324	
M14	55mm		SA 0303	
		100mm	SA 0313	
		140mm	SA 0319	
		200mm	SA 0325	

HEX IMPACT SOCKET BITS



SIZE	SHORT	LONG	REF	PRICE
4mm		78mm	SA 0476	
5mm		78mm	SA 0477	
6mm		78mm	SA 0478	
8mm		78mm	SA 0479	
10mm		78mm	SA 0480	
12mm		78mm	SA 0481	
14mm		78mm	SA 0482	
17mm		78mm	SA 0483	
19mm		78mm	SA 0484	
COFFRET		78mm	OM 7112	



RIBE IMPACT SOCKET BITS



SIZE	SHORT	LONG	REF	PRICE
M5		78mm	SA 0450	
M6		78mm	SA 0451	
M7		78mm	SA 0452	
M8		78mm	SA 0453	
M9		78mm	SA 0454	
M10		78mm	SA 0455	
M12		78mm	SA 0456	
M13		78mm	SA 0457	
M14		78mm	SA 0458	
COFFRET		78mm	OM 7113	

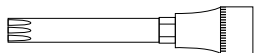

TORX SOCKET BITS

SIZE	SHORT	LONG	REF	PRICE
T20	55mm		SA 0261	
		100mm	SA 0273	
T25	55mm		SA 0262	
		100mm	SA 0274	
T27	55mm		SA 0264	
		100mm	SA 0275	
T30	55mm		SA 0265	
		100mm	SA 0276	
T40	55mm		SA 0266	
		100mm	SA 0277	
		140mm	SA 0283	
		200mm	SA 0289	
T45	55mm		SA 0267	
		100mm	SA 0278	
		140mm	SA 0284	
		200mm	SA 0290	
T50	55mm		SA 0268	
		100mm	SA 0279	
		140mm	SA 0285	
		200mm	SA 0291	
T55	55mm		SA 0269	
		100mm	SA 0280	
		140mm	SA 0286	
		200mm	SA 0292	
T60	55mm		SA 0271	
		100mm	SA 0281	
		140mm	SA 0287	
		200mm	SA 0293	
T70	55mm		SA 0272	
		100mm	SA 0282	
		140mm	SA 0288	
		200mm	SA 0294	

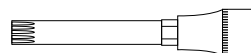

XZN SOCKET BITS

SIZE	SHORT	LONG	REF	PRICE
M5	55mm		SA 0343	
		100mm	SA 0351	
		140mm	SA 0359	
M6	55mm		SA 0344	
		100mm	SA 0352	
		140mm	SA 0360	
M8	55mm		SA 0345	
		100mm	SA 0353	
		140mm	SA 0361	
		200mm	SA 0366	
M9	55mm		SA 0346	
		100mm	SA 0354	
		140mm	SA 0362	
M10	55mm		SA 0347	
		100mm	SA 0356	
		140mm	SA 0363	
		200mm	SA 0367	
M12	55mm		SA 0348	
		100mm	SA 0357	
		140mm	SA 0364	
		200mm	SA 0368	
M14	55mm		SA 0349	
		100mm	SA 0358	
		140mm	SA 0365	
		200mm	SA 0369	
M16	55mm		SA 0350	
		100mm	SA 0408	

TORX IMPACT SOCKET BITS



SIZE	SHORT	LONG	REF	PRICE
T20		78mm	SA 7009	
T25		78mm	SA 7012	
T30		78mm	SA 7013	
T40		78mm	SA 2352	
T45		78mm	SA 7019	
T50		78mm	SA 7023	
T55		78mm	SA 7024	
T60		78mm	SA 7025	
T70		78mm	SA 7026	
COFFRET		78mm	OM 7009	



XZNIMPACT SOCKET BITS



SIZE	SHORT	LONG	REF	PRICE
M12		78mm	SA 0466	
M14		78mm	SA 0467	
M16		78mm	SA 0468	



OM 2335

30 PCS HEX 1/2" SOCKET BIT SET



Contents:

- 9 sockets L.55mm :
5, 6, 7, 8, 10, 12, 14, 17, 19mm
- 8 sockets L.100mm:
5, 6, 7, 8, 10, 11, 12, 13mm
- 7 sockets L.140mm :
5, 6, 7, 8, 10, 12, 14mm
- 6 sockets L.200mm:
5, 6, 7, 8, 10, 12mm

Available in retail: see our website.



OM 2334

26 PCS XZN 1/2" SOCKET BIT SET



Contents:

- 10 sockets L.55mm :
T20, T25, T27, T30, T40, T45, T50, T55, T60, T70
- 10 sockets L.100mm:
T20, T25, T27, T30, T40, T45, T50, T55, T60, T70
- 6 sockets L.140mm :
T40, T45, T50, T55, T60, T70
- 6 sockets L.200mm :
T40, T45, T50, T55, T60, T70

Available in retail: see our website.



OM 2333

32 PCS TORX SOCKET 1/2" BIT SET



Contents:

- 8 sockets L.55mm :
M5, M6, M8, M9, M10, M12, M14, M16
- 7 sockets L.100mm :
M5, M6, M8, M9, M10, M12, M14
- 7 sockets L.140mm :
M5, M6, M8, M9, M10, M12, M14
- 4 sockets L.200mm :
M8, M10, M12, M14

Available in retail: see our website.



OM 2336

32 PCS RIBE 1/2" SOCKET BIT SET



Contents:

- 9 sockets L.55mm:
M5, M6, M7, M8, M9, M10, M12, M13, M14
- 9 sockets L.100mm :
M5, M6, M7, M8, M9, M10, M12, M13, M14
- 7 sockets L.140mm :
M8, M9, M10 (VW), M10.3 (FIAT), M12, M13, M14
- 7 sockets L.200mm:
M8, M9, M10 (VW), M10.3 (FIAT), M12, M13, M14

Available in retail: see our website.



OM 2337

38 PCS SOCKET BIT SET



Specific cavities for working on: injection pumps, oil changing, airbags, gearbox, brakes...

Contents:

- 6x140mm Torx sockets:
T40, T45, T50, T55, T60, T70
- 2 tamper sockets:
T30x300mm, T80x100mm
- 9 hex sockets:
7x230mm, 10x140mm, 11x140mm, 13x140mm, 14x55mm, 17x55mm, 19x55mm, 22x55mm, 24x55mm
- 1 ball hex socket: 5x160mm
- 5 XZN sockets:
M9x100mm, M10x140mm, M12x140mm, M14x140mm, M16x100mm
- 1 XZN socket M16x55mm
- 1 impact XZN socket M18x78mm 1/2"D.
- 9 TS socket:
10, 15, 20, 25, 27, 30, 40, 45, 50 1/4" D.
- 4 Ribe sockets: M7x240mm, M8x240mm, M9x100mm, M10x140mm

Available in retail: see our website.



OM 7009

IMPACT TORX SOCKETS SET 1/2" D. T20-T25-T30-T40-T45-T50-T55-T60-T70



Contents:

- SA7009: impact socket bit T20
- SA7012: impact socket bit T25
- SA7013: impact socket bit T30
- SA2352: impact socket bit T40
- SA7019: impact socket bit T45
- SA7023: impact socket bit T50
- SA7024: impact socket bit T55
- SA7025: impact socket bit T60
- SA7026: impact socket bit T70



OM 7112

1/2" D. IMPACT HEX BIT IMPACT SOCKET SET 80mm H4-H19



Contents:

- SA0476: socket H4 L.78mm
- SA0477: socket H5 L.78mm
- SA0478: socket H6 L.78mm
- SA0479: socket H8 L.78mm
- SA0480: socket H10 L.78mm
- SA0481: socket H12 L.78mm
- SA0482: socket H14 L.78mm
- SA0483: socket H17 L.78mm
- SA0484: socket H19 L.78mm



OM 7113

IMPACT RIBE WRENCH END SET 1/2" D. 78mm M5-M14



Contents:

- SA0450: Ribe impact socket bit M5 L.78mm
- SA0451: Ribe impact socket bit M6 L.78mm
- SA0452: Ribe impact socket bit M7 L.78mm
- SA0453: Ribe impact socket bit M8 L.78mm
- SA0454: Ribe impact socket bit M9 L.78mm
- SA0455: Ribe impact socket bit M10 L.78mm
- SA0456: Ribe impact socket bit M12 L.78mm
- SA0457: Ribe impact socket bit M13 L.78mm
- SA0458: 1/2" D Ribe impact socket bit M14 L.78mm



OM 9354

13 PCS XZN TIP+TIP HOLDER 1/2" SET



Contents:

- SA2310: bit holder 1/2" 10mm
- SA9251: RIBE M5 L.30mm
- SA9252: RIBE M6 L.30mm
- SA9253: RIBE M7 L.30mm
- SA9254: RIBE M8 L.30mm
- SA9255: RIBE M10 L.30mm
- SA9256: RIBE M12 L.30mm
- SA9257: RIBE M7 L.100mm
- SA9258: RIBE M8 L.100mm
- SA9273: RIBE M9 L.100mm
- SA9279: RIBE M10 L.100mm
- SA9306: RIBE M12 L.100mm
- SA9309: RIBE M13 L.100mm
- SA9335: RIBE M14 L.100mm

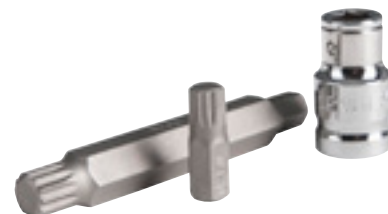

OM 9254

13 PCS RIBE TAMPERPROOF TIP+TIP HOLDER 1/2" SET



Contents:

- SA2312: short bit XZN M5
- OS6020: short bit XZN M6
- SA2355: short bit XZN M7
- OS6021: short bit XZN M8
- OS6022: short bit XZN M10
- SA2316: short bit XZN M12
- SA2356: long bit XZN M7
- SA2337: long bit XZN M8
- SA2357: long bit XZN M9
- OS6042: long bit XZN M10
- OS6009: long bit XZN M12
- SA2358: long bit XZN M13
- SA2359: long bit XZN M14
- SA2310: bit holder 1/2" 10mm



3/4"

20

DOUBLE HEX SOCKET



SIZE	BLINE	INTENSIF	REF	PRICE
22mm	•		OS 3411	
24mm	•		OS 3412	
27mm	•		OS 3413	
30mm	•		OS 3414	
32mm	•		OS 3415	
36mm	•		OS 3416	
38mm	•		OS 3417	
41mm	•		OS 3418	
46mm	•		OS 3419	
50mm	•		OS 3420	

HEX SOCKET



SIZE	BLINE	INTENSIF	REF	PRICE
22mm		•	OS 3451	
24mm		•	OS 3452	
27mm		•	OS 3453	
30mm		•	OS 3454	
32mm		•	OS 3455	
36mm		•	OS 3456	
38mm		•	OS 3457	
41mm		•	OS 3458	
46mm		•	OS 3459	
50mm		•	OS 3460	

TORX SOCKET BITS



SIZE	SHORT	LONG	REF	PRICE
T70			SA 0470	
T80			SA 0471	
T90			SA 0472	
T100			SA 0473	

XZN SOCKET BITS



SIZE	SHORT	LONG	REF	PRICE
M16			SA 0474	
M18			SA 0475	

HEX IMPACT SOCKET BIT



SIZE	SHORT	LONG	REF	PRICE
26mm	•		OS 3401	
		•	OS 3431	
27mm	•		OS 3402	
		•	OS 3432	
29mm	•		OS 3403	
		•	OS 3433	
30mm	•		OS 3404	
		•	OS 3434	
32mm	•		OS 3405	
		•	OS 3435	
35mm	•		OS 3406	
		•	OS 3436	
36mm	•		OS 3407	
		•	OS 3437	
38mm	•		OS 3408	
		•	OS 3438	

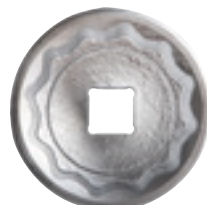

OM 0065

HUB WRENCH DOUBLE HEX Ø65mm
3/4" IVECO DAILY/FORD TRANSIT

OM 0156

3/4" D. DOUBLE HEX SOCKET Ø56mm
FORD TRANSIT



OM 0043	1"x3/4" REDUCER
OM 0044	3/4"D. x 1/2"D. REDUCER
OM 0045	1/2"D.x3/4" D. AUGMENTER



OS 3430

3/4" LONG HEX IMPACT SOCKET SET
26-38mm



Contents:

- OS3431: 3/4" hex impact socket 26mm
- OS3432: 3/4" hex impact socket 27mm
- OS3433: 3/4" hex impact socket 29mm
- OS3434: 3/4" hex impact socket 30mm
- OS3435: 3/4" hex impact socket 32mm
- OS3436: 3/4" hex impact socket 35mm
- OS3437: 3/4" hex impact socket 36mm
- OS3438: 3/4" hex impact socket 38mm

NEW

DIN ISO 3129



OS 3400

HEX 8 IMPACT SOCKET KIT 26-38mm 3/4"



DIN ISO 2725-3

Contents:

- OS3401: impact socket 26mm
- OS3402: impact socket 27mm
- OS3403: impact socket 29mm
- OS3404: impact socket 30mm
- OS3405: impact socket 32mm
- OS3406: impact socket 35mm
- OS3407: impact socket 36mm
- OS3408: impact socket 38mm



OM 2332

HGV 3/4" SOCKET SET XZN 16-18 TORX T70-T80-T90-T100



Contents:

- SA0470: Socket T70
- SA0471: Socket T80
- SA0472: Socket T90
- SA0473: Socket T100
- SA0474: Socket XZN M16
- SA0475: Socket XZN M18



OS 3450

RATCHET+10 HEX SOCKET SET 3/4" D.



Contents:

- OS3451: 3/4" hex socket 22mm
- OS3452: 3/4" hex socket 24mm
- OS3453: 3/4" hex socket 27mm
- OS3454: 3/4" hex socket 30mm
- OS3455: 3/4" hex socket 32mm
- OS3456: 3/4" hex socket 36mm
- OS3457: 3/4" hex socket 38mm
- OS3458: 3/4" hex socket 41mm
- OS3459: 3/4" hex socket 46mm
- OS3460: 3/4" hex socket 50mm
- OS3461: 3/4" ratchet
- OS3462: 3/4" extension 200mm
- OS3463: 3/4" extension 400mm
- OS3464: sliding T-handle 3/4" L.500mm

OS 3461	3/4" RATCHET
OS 3464	3/4" SLIDING T-HANDLE L.500mm
OS 3462	3/4" EXTENSION L.200mm
OS 3463	3/4" EXTENSION L.400mm



OM 2355BL

RATCHET+10 DOUBLE HEX SOCKET SET 3/4" D. 22-50mm

B.LINE



Contents:

- OS3411: double hex socket 22mm
- OS3412: double hex socket 24mm
- OS3413: double hex socket 27mm
- OS3414: double hex socket 30mm
- OS3415: double hex socket 32mm
- OS3416: double hex socket 36mm
- OS3417: double hex socket 38mm
- OS3418: double hex socket 41mm
- OS3419: double hex socket 46mm
- OS3420: double hex socket 50mm
- OS3421: ratchet
- OS3422: extension 100mm
- OS3423: extension 200mm
- OS3424: CV joint
- OS3425: sliding T handle

OS 3461	3/4" RATCHET
OS 3464	3/4" SLIDING T-HANDLE L.500mm
OS 3462	3/4" EXTENSION L.200mm
OS 3463	3/4" EXTENSION L.400mm



OS 3426

3/4" DRIVE L. 950MM FORCE HINGED HANDLE

Maximum leverage effect



Specifications:

- force hinged handle with replaceable head (SA3026)
- drive: 3/4"
- length: 950mm



1"

25

HEX SOCKETS



SIZE	BLINE	INTENSIF	REF	PRICE
36mm	•		OS 3511	
38mm	•		OS 3512	
41mm	•		OS 3513	
46mm	•		OS 3514	
		•	OS 3551	
50mm	•		OS 3515	
		•	OS 3552	
55mm	•		OS 3516	
		•	OS 3553	
60mm	•		OS 3517	
		•	OS 3554	
65mm	•		OS 3518	
		•	OS 3555	
70mm	•		OS 3519	
		•	OS 3556	
75mm	•		OS 3520	
		•	OS 3557	
80mm	•		OS 3521	
		•	OS 3558	

HEX IMPACT SOCKETS



SIZE	SHORT	LONG	REF	PRICE
24mm	•		OS 3501	
		•	OS 3531	
27mm	•		OS 3502	
		•	OS 3532	
30mm	•		OS 3503	
		•	OS 3533	
32mm	•		OS 3504	
		•	OS 3534	
35mm	•		OS 3505	
		•	OS 3535	
38mm	•		OS 3506	
		•	OS 3536	
41mm	•		OS 3507	
		•	OS 3537	
46mm	•		OS 3508	
		•	OS 3538	
50mm	•		OS 3509	
		•	OS 3539	
65mm	•		OM 0565	
67mm	•		OM 0567	
85mm	•		OM 0585	

OM 0043

1"x3/4" REDUCER



TORQUE CONTROL IMPACT SOCKETS



SIZE	COUPLE	REF	PRICE
32mm	450Nm	OM 0400	
	500Nm	OM 0401	
33mm	550Nm	OM 0402	
	650Nm	OM 0403	



OS 3500

9 HEX IMPACT SOCKET KIT 24-50mm 1"



Impact wrenches p.80

Contents:

- OS3501: impact socket 24mm
- OS3502: impact socket 27mm
- OS3503: impact socket 30mm
- OS3504: impact socket 32mm
- OS3505: impact socket 35mm
- OS3506: impact socket 38mm
- OS3507: impact socket 41mm
- OS3508: impact socket 46mm
- OS3509: impact socket 50mm

**OS 3530**1" LONG HEX IMPACT SOCKET SET 24-50mm
9 PCS**NEW****Contents:**

- OS3531: 1" long hex impact socket 24mm
- OS3532: 1" long hex impact socket 27mm
- OS3533: 1" long hex impact socket 30mm
- OS3534: 1" long hex impact socket 32mm
- OS3535: 1" long hex impact socket 35mm
- OS3536: 1" long hex impact socket 8mm
- OS3537: 1" long hex impact socket 41mm
- OS3538: 1" long hex impact socket 46mm
- OS3539: 1" long hex impact socket 50mm

DIN ISO 3129



OM 2354BL

RATCHET HANDLE + 11 HEX SOCKETS 1" D. FOR HGV 36-80

B.LINE



Contents:

- OS3511: hex socket 36mm
- OS3512: hex socket 38mm
- OS3513: hex socket 41mm
- OS3514: hex socket 46mm
- OS3515: hex socket 50mm
- OS3516: hex socket 55mm
- OS3517: hex socket 60mm
- OS3518: hex socket 65mm
- OS3519: hex socket 70mm
- OS3520: hex socket 75mm
- OS3521: hex socket 80mm
- OS3522: ratchet
- OS3523: extension 190mm
- OS3524: extension 365mm
- OS3525: sliding T handle

OS 3522	1" RATCHET	Spare part of OM 2354
OS 3525	1" SLIDING T-HANDLE	Spare part of OM 2354
OS 3523	1" EXTENSION L.185mm	Spare part of OM 2354
OS 3524	1" EXTENSION L.365mm	Spare part of OM 2354



OS 3550

RATCHET+8 HEX SOCKET SET 1" D.

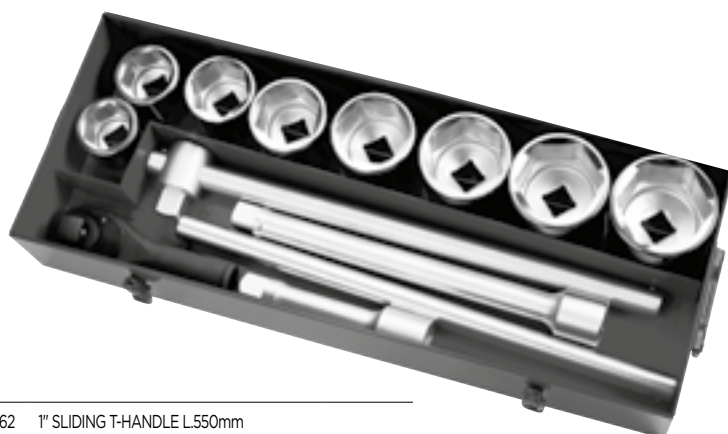

Contents:

- OS3551: 1" hex socket 46mm
- OS3552: 1" hex socket 50mm
- OS3553: 1" hex socket 55mm
- OS3554: 1" hex socket 60mm
- OS3555: 1" hex socket 65mm
- OS3556: 1" hex socket 70mm
- OS3557: 1" hex socket 75mm
- OS3558: 1" hex socket 80mm
- OS3559: ratchet
- OS3560: extension 200mm
- OS3561: extension 400mm
- OS3562: 1" sliding T-handle L.550mm

OS 3562	1" SLIDING T-HANDLE L.550mm
OS 3561	1" EXTENSION 400mm
OS 3560	1" EXTENSION 200mm
OS 3559	1" RATCHET



OM 4535

TORQUE MULTIPLIER R1:58 4800Nm+6 SOCKETS + 2 ADAPTERS 1" HGV



Contents:

- torque multiplier R1:58 L.270mm
- extension L.255mm
- sockets 24-27-30-32-33-38mm, H.80mm 1" drive
- adapters 1" female-female and 3/4" male-1" female H.80mm

Torquing and releasing



DYNAMOMETRY

Double graduation: Nm and ft/lb
Conform DIN ISO 6789 2017-1



OM 0776

TORQUE WRENCH 3/8" D. 30-110Nm
361mm

NEW

Delivered with
calibration certificate

OM 0779

TORQUE WRENCH 1/2"D. 42-210Nm
461mm

NEW



OM 0772

TORQUE WRENCH 3/4" 100-
500Nm 840mm

OM 0778

TORQUE WRENCH 1" D. 200-
1000Nm 1200mm

NEW

SA 0770	3/8" PAWL REPAIR KIT	Spare part of OM 0770/OM 0776/OM 0784
SA 0769	1/2" PAWL REPAIR KIT	Spare part of OM 0775/OM 0771/OM 0779
SA 0768	3/4" PAWL REPAIR KIT	Spare part of OM 0772
SA 0767	1" PAWL REPAIR KIT	Spare part of OM 0773/OM 0778

Impact torque extension p.115
and torque control impact socket
HGV p.124



OM 0784

TORQUE WRENCH WITH
INTERCHANGEABLE HEADS 3/8" D.
30-110Nm 331mm

NEW

Heads: 10-11-12-13-14-15-16-17-18-19
Conform DIN ISO 6789 2017-1

2
WARRANTY



OM 0769

TORQUE WRENCH 1/4" 4-20Nm 335mm

Delivered with
calibration certificate



OM 0790BL

TORQUE WRENCH 1/2" 42-210Nm 450mm

Delivered with
calibration certificate

B.LINE



OM 0765

120Nm PRESET 1/2" D. TORQUE WRENCH

Delivered with
calibration certificate

Essential for tightening wheels: thanks to its preset torque, the operator does not waste time. The torque wrench is 375mm long and has a 105° angle for a quick tightening of studs. It makes a click sound when torque is reached.



Specifications:

- release accuracy ± 4%
- DIN ISO standard: 6789
- weight: 825g
- length: 375mm

DIN ISO standard: 6789



OM 0764BL

TELESCOPIC L-SHAPED WRENCH 1/2"

B.LINE



- length: 365-530mm
- holds sockets in place using ball bearings



OM 0750

1/2" D. ANGLE WRENCH WITH
MAGNETIZED ARM



TIGHTENING KEYS

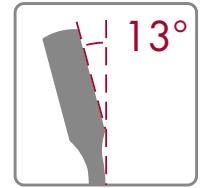

Format: 1/3 drawer



OS 4100

17 PCS COMBINATION WRENCH INSERT 6-24mm

OS 4101	COMBINATION WRENCH 6mm
OS 4102	COMBINATION WRENCH 7mm
OS 4103	COMBINATION WRENCH 8mm
OS 4104	COMBINATION WRENCH 9mm
OS 4105	COMBINATION WRENCH 10mm
OS 4106	COMBINATION WRENCH 11mm
OS 4107	COMBINATION WRENCH 12mm
OS 4108	COMBINATION WRENCH 13mm
OS 4109	COMBINATION WRENCH 14mm
OS 4110	COMBINATION WRENCH 15mm
OS 4111	COMBINATION WRENCH 16mm
OS 4112	COMBINATION WRENCH 17mm
OS 4113	COMBINATION WRENCH 18mm
OS 4114	COMBINATION WRENCH 19mm
OS 4115	COMBINATION WRENCH 21mm
OS 4116	COMBINATION WRENCH 22mm
OS 4117	COMBINATION WRENCH 24mm

OS 4200

4 PCS COMBINATION WRENCH INSERT 27-32mm

OS 4201	COMBINATION WRENCH 27mm
OS 4202	COMBINATION WRENCH 29mm
OS 4203	COMBINATION WRENCH 30mm
OS 4204	COMBINATION WRENCH 32mm

Insert dimensions: 390x185x50mm
 Finish: micro satin
 Material: chrome vanadium
 DIN ISO 3113

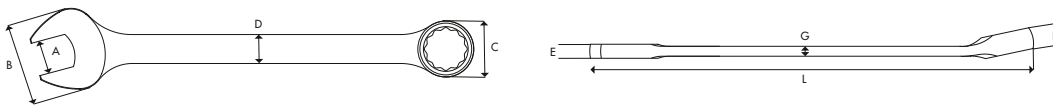

A	B	C	D	E	F	G	L	Angle
6	16,5	10,5	7	3,7	4,5	2,3	100	10-15°
7	18,3	11,6	7,5	3,7	5	2,4	110	10-15°
8	20,5	13,4	8,8	4,1	5,5	2,8	120	10-15°
9	22,4	14,8	9,4	4,1	6	3	130	10-15°
10	24	16,1	9,8	4,6	6,5	3,2	140	10-15°
11	26	17,7	10,6	4,7	6,5	3,5	150	10-15°
12	27,8	19,1	11,4	4,8	7	3,6	160	10-15°
13	28,8	20,5	12	5,5	7,5	3,9	170	10-15°
14	31,8	22,2	12,6	5,6	8	4,2	180	10-15°
15	34,5	23,6	13,5	5,7	8,5	4,3	190	10-15°
16	36,6	24,8	14	5,8	9	4,3	200	10-15°
17	38,6	26,4	15	6,3	9,5	4,5	210	10-15°
18	39,4	27,7	15,4	6,8	10	4,6	220	10-15°
19	42,5	29,2	15,9	7,1	10,4	4,7	230	10-15°
21	45,2	31,8	17,4	7,5	11,4	5,1	250	10-15°
22	48,6	33,4	18,5	8	11,9	5,4	260	10-15°
24	51	35,8	19,5	8,2	12,9	5,6	280	10-15°



OS 4020

12PCS ADJUSTABLE RATCHETING COMBINATION WRENCH INSERT 15° 8-19mm

NEW

Format: 1/3 drawer



Insert dimensions:
390x185x50mm
Finish: micro satin
Material: chrome vanadium
DIN ISO 691
DIN ISO 1711-1

OS 4021	ADJUSTABLE RATCHETING COMBINATION WRENCH 15° 8mm
OS 4022	ADJUSTABLE RATCHETING COMBINATION WRENCH 15° 9mm
OS 4023	ADJUSTABLE RATCHETING COMBINATION WRENCH 15° 10mm
OS 4024	ADJUSTABLE RATCHETING COMBINATION WRENCH 15° 11mm
OS 4025	ADJUSTABLE RATCHETING COMBINATION WRENCH 15° 12mm
OS 4026	ADJUSTABLE RATCHETING COMBINATION WRENCH 15° 13mm
OS 4027	ADJUSTABLE RATCHETING COMBINATION WRENCH 15° 14mm
OS 4028	ADJUSTABLE RATCHETING COMBINATION WRENCH 15° 15mm
OS 4029	ADJUSTABLE RATCHETING COMBINATION WRENCH 15° 16mm
OS 4030	ADJUSTABLE RATCHETING COMBINATION WRENCH 15° 17mm
OS 4031	ADJUSTABLE RATCHETING COMBINATION WRENCH 15° 18mm
OS 4032	ADJUSTABLE RATCHETING COMBINATION WRENCH 15° 19mm

Contents:

- OS4021: adjustable ratcheting combination wrench 8mm
- OS4022: adjustable ratcheting combination wrench 9mm
- OS4023: adjustable ratcheting combination wrench 10mm
- OS4024: adjustable ratcheting combination wrench 11mm
- OS4025: adjustable ratcheting combination wrench 12mm
- OS4026: adjustable ratcheting combination wrench 13mm
- OS4027: adjustable ratcheting combination wrench 14mm
- OS4028: adjustable ratcheting combination wrench 15mm
- OS4029: adjustable ratcheting combination wrench 16mm
- OS4030: adjustable ratcheting combination wrench 17mm
- OS4031: adjustable ratcheting combination wrench 18mm
- OS4032: adjustable ratcheting combination wrench 19mm



OS 4499

SET OF 5 HEX SOCKET SPANNERS

Finish: micro satin
Material: chrome vanadium



OS 4401	HEX SOCKET SPANNER 20mm
OS 4402	HEX SOCKET SPANNER 21mm
OS 4403	HEX SOCKET SPANNER 22mm
OS 4404	HEX SOCKET SPANNER 23mm
OS 4405	HEX SOCKET SPANNER 24mm

Contents:

- OS4401: hex socket spanner 20mm
- OS4402: hex socket spanner 21mm
- OS4403: hex socket spanner 22mm
- OS4404: hex socket spanner 23mm
- OS4405: hex socket spanner 24mm

**OS 4399**

SET OF 12 HEX. SOCKET SPANNERS

Finish: micro satin
Material: chrome vanadium

OS 4301	HEX SOCKET SPANNER 8mm
OS 4302	HEX SOCKET SPANNER 9mm
OS 4303	HEX SOCKET SPANNER 10mm
OS 4304	HEX SOCKET SPANNER 11mm
OS 4305	HEX SOCKET SPANNER 12mm
OS 4306	HEX SOCKET SPANNER 13mm
OS 4307	HEX SOCKET SPANNER 14mm
OS 4308	HEX SOCKET SPANNER 15mm
OS 4309	HEX SOCKET SPANNER 16mm
OS 4310	HEX SOCKET SPANNER 17mm
OS 4311	HEX SOCKET SPANNER 18mm
OS 4312	HEX SOCKET SPANNER 19mm



PLIERS



OS 5000

4 PCS PLIER INSERT

Contents:

- OS5001: cutting pliers L.160mm
Capacity: Ø2-4mm wires
Steel 1060 high durability
TPE+TPR Gained handle
DIN ISO 5749 standard
- OS5002: long-nosed pliers L.200mm
Steel 1060 high durability
TPE+TPR Gained handle
DIN ISO 5745 standard
- OS5003: combination pliers L.180mm
Steel 1060 high durability
TPE+TPR Gained handle
DIN ISO 5746 standard
- OS5004: adjustable joint L.250mm
7 positions
Max opening: 42mm
Steel 1060 high durability
TPE+TPR Gained handle
DIN ISO 8976 standard

Format: 1/3 drawer

Insert dimensions: 390x185x50mm



OS 5003

COMBINATION PLIERS
L.180mm

Spare part of OS 5000/OS 5099



OS 5004

ADJUSTABLE JOINT
L.250mm

Spare part of OS 5000/OS 5099



OS 5001

CUTTING PLIERS
L.160mm

Spare part of OS 5000/OS 5099



OS 5002

LONG-NOSED
PLIERS L.200mm

Spare part of OS 5000/OS 5099



OS 5099

4 PLIERS SET



OS 5014

14" ALUMINUM CLAW WRENCH

**NEW**

Lightweight, aluminum alloy, anti-corrosion treatment, forged steel jaws

Specifications:

- length: 320mm
- opening: 50mm
- weight: 920g

**OS 5024**

24" ALUMINUM CLAW WRENCH

**NEW**

Lightweight, aluminum alloy, anti-corrosion treatment, forged steel jaws

Specifications:

- length: 607mm
- opening: 76mm
- weight: 2400g

**OS 5005**QUICK-ADJUSTING HGV
WATER PUMP PLIER 300mm**Specifications:**

- 32 positions
- max. openings 70mm
- 58HRC high strength steel
- standard DIN ISO 896





OS 5200

4PCS CIRCLIP PLIER INSERT 7" INSIDE-OUTSIDE



Features :

- invisible spring
- material: body: S45C / 43-48HRC. Clamp: 48-52HRC bearing steel
- high tensile strength steel tips
- bolted joint
- DIN ISO 5254 (Exterior) and ISO 5256 (Interior)

Contents:

- OS5201: straight plier inner circlip 7"
- OS5202: straight plier external circlip 7"
- OS5203: curved plier external circlip 7"
- OS5204: curved plier inner circlip 7"

NEW



DIN ISO 5256



OS 5201

STRAIGHT PLIER
INNER CIRCLIP 7"

NEW

DIN ISO 5254



OS 5202

STRAIGHT PLIER
EXTERNAL
CIRCLIP 7"

NEW

DIN ISO 5254



OS 5203

CURVED PLIER
EXTERNAL
CIRCLIP 7"

NEW

DIN ISO 5256



OS 5204

CURVED PLIER
INNER CIRCLIP 7"

NEW





CO 0527	300 PCS 3-32mm EXTERNAL CIRCLIP SET
CO 0526	300 PCS 3-32mm INTERNAL CIRCLIP SET
CO 0525	300 PCS E TYPE EXTERNAL CIRCLIP SET 1.5-22mm

NO
WARRANTY

OS 5105

INTERNAL/EXTERNAL CIRCLIP PLIERS



Max. opening: 75mm

Specifications:

- simple to adjust using the 3/8" screw
- 12 pairs of interchangeable end-fittings:
 - straight: 2.5, 3.0, 3.5, 3.8mm
 - 45° angled: 2.5, 3.0, 3.5, 3.8mm
 - 90° angled: 2.5, 3.0, 3.5, 3.8mm
- length: 305mm
- max. opening: 75mm



2
WARRANTY

OM 0111

2 PCS HGV CIRCLIP SET (INTERIOR-EXTERIOR)



Maximum opening:
85mm



Specifications:

- simple to adjust using the stand
- 3 pairs of interchangeable end fittings for each set
- length 420mm
- max. opening: 75mm

2
WARRANTY

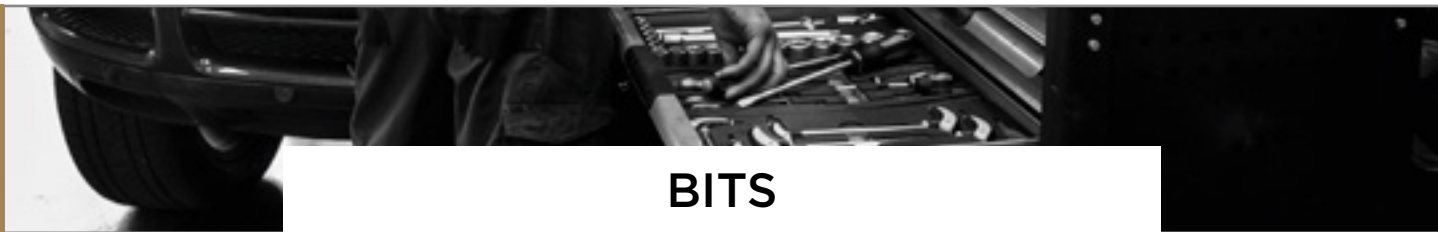

BITS



OS 1000

8 PCS SCREWDRIVER INSERT

Insert dimensions: 390x185x50mm
 SVCM steel blade
 PP+TPV Dual material handle
 DIN ISO 2380
 DIN ISO 8764

Format: 1/3 drawer



OS 1001	PHILLIPS SCREWDRIVER 0x75
OS 1002	PHILLIPS TOM THUMB SCREWDRIVER 1x38
OS 1003	PHILLIPS SCREWDRIVER 2x125
OS 1004	SLOTTED SCREWDRIVER 3x75
OS 1005	SLOTTED TOM THUMB SCREWDRIVER 5.5x38
OS 1006	SLOTTED SCREWDRIVER 5.5x100
OS 1007	SLOTTED SCREWDRIVER 6.5x150
OS 1008	SLOTTED SCREWDRIVER 8x200

OS 1099

8 PCS SCREWDRIVER SET



Contents:

- OS1001: phillips screwdriver 0x75
- OS1002: phillips screwdriver 1x38
- OS1003: phillips screwdriver 2x125
- OS1004: slotted screwdriver 3x75
- OS1005: slotted screwdriver 5.5x38
- OS1006: slotted screwdriver 5.5x100
- OS1007: slotted screwdriver 6.5x150
- OS1008: slotted screwdriver 8x200

SVCM steel blade
 PP+TPV Dual material handle
 DIN ISO 2380
 DIN ISO 8764



Format: 1/3 drawer

Insert dimensions: 390x185x50mm
 SVCM steel blade
 PP+TPV Dual material handle
 DIN ISO 8764



OS 1100

7 PCS TORX SCREWDRIVER INSERT T10-40

OS 1101	TORX SCREWDRIVER T10x100
OS 1102	TORX SCREWDRIVER T15x100
OS 1103	TORX SCREWDRIVER T20x100
OS 1104	TORX SCREWDRIVER T25x100
OS 1105	TORX SCREWDRIVER T27x100
OS 1106	TORX SCREWDRIVER T30x100
OS 1107	TORX SCREWDRIVER T40x100

OS 1199

7 PCS SCREWDRIVER TORX SET T10-40

Contents:

- OS1101: torx screwdriver T10x100
- OS1102: torx screwdriver T15x100
- OS1103: torx screwdriver T20x100
- OS1104: torx screwdriver T25x100
- OS1105: torx screwdriver T27x100
- OS1106: torx screwdriver T30x100
- OS1107: torx screwdriver T40x100





Insert dimensions: 390x185x50mm
 SVCM steel blade
 PP+TPV Dual material handle
 DIN ISO 2396



OS 2000

7 PCS HEX T-HANDLE WRENCH INSERT 3-10mm

Format: 1/3 drawer



OS 2001	T-HANDLE WRENCH H3 x 100
OS 2002	T-HANDLE WRENCH H4 x 110
OS 2003	T-HANDLE WRENCH H5x160
OS 2004	T-HANDLE WRENCH H6 x 160
OS 2005	T-HANDLE WRENCH H7 x 160
OS 2006	T-HANDLE WRENCH H8 x 200
OS 2007	T-WRENCH H10x215

OS 2099

7 PCS HEX T-HANDLE WRENCH SET 3-10mm



Contents:

- OS2001: T handle screwdriver H3x110
- OS2002: T handle screwdriver H4x110
- OS2003: T handle screwdriver H5x110
- OS2004: T handle screwdriver H6x160
- OS2005: T handle screwdriver H7x160
- OS2006: T handle screwdriver H8x200
- OS2007: T handle screwdriver H10x215



OS 2100**7 PCS T-HANDLE WRENCH INSERT TORX T10-T40**

Insert dimensions:
390x185x50mm
SVCN steel blade
PP+TPV Dual material
handle



Format: 1/3 drawer

OS 2101	T-HANDLE WRENCH T10x110
OS 2102	T-HANDLE WRENCH T15x110
OS 2103	T-HANDLE WRENCH T20x110
OS 2104	T-HANDLE WRENCH T25x160
OS 2105	T-HANDLE WRENCH T27x160
OS 2106	T-HANDLE WRENCH T30x160
OS 2107	T-HANDLE WRENCH T40x185

**OS 2199****7 PCS T-HANDLE WRENCH SET TORX T10-T40****Contents:**

- OS2101: T-handle wrench T10x110
- OS2102: T-handle wrench T15x110
- OS2103: T-handle wrench T20x110
- OS2104: T-handle wrench T25x160
- OS2105: T-handle wrench T27x160
- OS2106: T-handle wrench T30x160
- OS2107: T-handle wrench T40x185





OS 3220

9 PCS SPHERICAL HEX KEY SET H1,5-10

Spare part of OS 3200

OS 3221	SPHERICAL HEX KEY H1,5
OS 3222	SPHERICAL HEX KEY H2
OS 3223	SPHERICAL HEX KEY H2,5
OS 3224	SPHERICAL HEX KEY H3
OS 3225	SPHERICAL HEX KEY H4
OS 3226	SPHERICAL HEX KEY H5
OS 3227	SPHERICAL HEX KEY H6
OS 3228	SPHERICAL HEX KEY H8
OS 3229	SPHERICAL HEX KEY H10

Material: SVCM steel



OM 7005

TS 7 KEY SET TS10-TS15-TS20-TS25-TS27-TS30-TS40



These 5 star bits are for brands: Renault, Peugeot, Mercedes, Rover and diesel injection pumps.



OM 0950

FLEXIBLE HOSE CLAMP DRIVER 6-7mm

Specifications:

- hose length: 200mm
- handle length: 120mm
- reversible socket 6 and 7mm

**OM 0669**

16 PCS IMPACT SCREWDRIVER SET

Bits :

- flat 5-6-8-10-12mm
- hex 4-5-6-8mm
- philips 1-2-3-4
- torx 40 (SA0656)
+ adapter

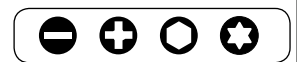
**OM 0640**

33 PRECISION SCREWDRIVER + BIT SET

**Contents:**

- 1 precision screwdriver
- 1 flexible extension bar 190mm
- 1 magnifying glass
- 30 bits
- Hex: 0.7-1.3-1.5-2-2.5-3-4mm
- Torx: T4-T5-T6-T7-T8-T9-T15-T20
- Slotted: 1-1.5-2-2.5-3-3.5-4mm
- Phillips: 000-0-1-2
- Pozidriv: 000-00-1-2

**OS 1010**

RATCHET SCREWDRIVER 6 BITS

**NEW****Specifications:**

- lockable ratchet system for clamping/untightening
- end piece length: 89mm
- total length: 230mm

Contents:

- OS1011: bit PH1
- OS1012: bit PH2
- OS1013: flat bit 4mm
- OS1014: flat bit 6mm
- OS1015: bit T20
- OS1016: bit T30



6.3

1/4"



BIT SETS

TYPE	DESIGNATION	REF	PRICE
	5 BITS SET 1/4" SHORT PZ1	OS 6002	
	5 BITS SET 1/4" SHORT PZ2	OS 6003	
+	5 BITS SET 1/4" SHORT PZ3	OS 6004	
	5 SCREWDRIVER BITS SET 1/4" H3	OS 3238	
	5 BITS SET 1/4" SHORT H4	OS 6005	
	5 BITS SET 1/4" SHORT H5	OS 6006	
○	5 BITS SET 1/4" SHORT H6	OS 6007	
	5 BITS SET 1/4" SHORT H7	OS 6008	
	5 SCREWDRIVER BITS SET 1/4" PH1	OS 3231	
	5 SCREWDRIVER BITS SET 1/4" PH2	OS 3232	
+	5 SCREWDRIVER BITS SET 1/4" PH3	OS 3233	
	5 SCREWDRIVER SLOTTED 3 BITS SET 1/4"	OS 3234	
	5 SCREWDRIVER SLOTTED 4 BITS SET 1/4"	OS 3235	
	5 SCREWDRIVER SLOTTED 5 BITS SET 1/4"	OS 3236	
—	5 SCREWDRIVER SLOTTED 6 BITS SET 1/4"	OS 3237	
	5 SCREWDRIVER BITS SET 1/4" T10	OS 3239	
	5 SCREWDRIVER BITS SET 1/4" T15	OS 3240	
	5 SCREWDRIVER BITS SET 1/4" T20	OS 3241	
	5 SCREWDRIVER BITS SET 1/4" T25	OS 3242	
☆	5 SCREWDRIVER BITS SET 1/4" T27	OS 3243	
	5 SCREWDRIVER BITS SET 1/4" T30	OS 3244	
	5 SCREWDRIVER BITS SET 1/4" T40	OS 3245	
	5 SCREWDRIVER BITS SET 1/4" TORX TAMPER T10	OS 3246	
	5 SCREWDRIVER BITS SET 1/4" TORX TAMPER T15	OS 3247	
	5 SCREWDRIVER BITS SET 1/4" TORX TAMPER T20	OS 3248	
	5 SCREWDRIVER BITS SET 1/4" TORX TAMPER T25	OS 3249	
☆	5 SCREWDRIVER BITS SET 1/4" TORX TAMPER T27	OS 3251	
	5 SCREWDRIVER BITS SET 1/4" TORX TAMPER T30	OS 3252	
	5 SCREWDRIVER BITS SET 1/4" TORX TAMPER T40	OS 3253	

HEX BITS

3/8"



10

SIZE	SHORT	LONG	REF	PRICE
H4	•		SA 2325	
		•	OS 6023	
H5	•		SA 2326	
		•	OS 6024	
H6	•		SA 2327	
		•	OS 6025	
H7	•		SA 2328	
		•	OS 6026	
H8	•		OS 6009	
		•	OS 6027	
H10	•		OS 6010	
		•	OS 6028	
H12	•		SA 2331	
		•	SA 2353	



- OS 3254 BIT HOLDER ADAPTOR 1/4" FOR SCREWERS
- OS 3255 HEX MALE ADAPTOR 1/4"-1/4" SQUARE L.25mm

TORX BITS



10

SIZE	SHORT	LONG	REF	PRICE
T20	•		SA 2317	
		•	SA 2340	
T25	•		SA 2318	
		•	SA 2341	
T30	•		SA 2319	
		•	OS 6035	
T40	•		SA 2320	
		•	OS 6036	
T45	•		OS 6017	
		•	OS 6037	
T50	•		OS 6018	
		•	OS 6038	
T55	•		OS 6019	
		•	SA 2346	
T60		•	SA 2347	
	•		SA 2324	

XZN BITS



10

SIZE	SHORT	LONG	REF	PRICE
M5	•		SA 2312	
		•	OS 6039	
M6	•		OS 6020	
		•	OS 6040	
M7	•		SA 2355	
		•	SA 2356	
M8	•		OS 6021	
		•	OS 6041	
M9		•	SA 2357	
M10	•		OS 6022	
		•	OS 6042	
M12	•		SA 2316	
		•	SA 2339	
M13		•	SA 2358	
M14		•	SA 2359	

TORX TEMPERPROOF



10

SIZE	SHORT	LONG	REF	PRICE
T10	•		OS 6011	
		•	OS 6029	
T15	•		OS 6012	
		•	OS 6030	
T20	•		OS 6013	
		•	OS 6031	
T25	•		OS 6014	
		•	OS 6032	
T30	•		OS 6015	
		•	OS 6033	
T40	•		OS 6016	
		•	OS 6034	

FLAT BITS



10

SIZE	SHORT	LONG	REF	PRICE
P02	•		SA 2334	
P03	•		SA 2335	

NO WARRANTY



OS 6000

43 PCS SPECIAL BIT INSERT

Contents:

- 7 short sockets L.30mm 1/4"
- Pozidrive: PZ1, PZ2, PZ3
- Hexagonal: H4, H5, H6, H7
- 14 short sockets L.30mm drive 10mm
- Hexagonal: H8, H10
- Torx tamper: T10, T15, T20, T25, T30, T35
- Torx: T45, T50, T55
- XZN: M6, M8, M10
- 20 long sockets L.75mm drive 10mm
- Hexagonal: H4, H5, H6, H7, H8, H10
- Torx tamper: T10, T15, T20, T25, T30, T40
- Torx: T30, T40, T45, T50
- XZN: M5, M6, M8, M10
- socket bits holder 1/4", square drive 1/4"
- socket bits holder 10mm, square drive 1/2"

Format: 1/3 drawer

OS 6001	BIT HOLDER 10mm HEXAGONAL-1/2" SQUARE	Spare part of OS 6000
OS 6043	BIT HOLDER 1/4" HEXAGONAL-1/4" SQUARE	Spare part of OS 6000/OS 3200

Insert dimensions: 390x185x50mm
 DIN ISO 1173
 DIN ISO 3126



OM 0655BL

100 PCS SCREW BIT SET



B.LINE



Contents:

- 1 magnetic bit holder
- 1 Y adapter
- 1 male adaptor/male square 1/4" hexagonal
- 1 female adaptor/female square 1/4" hexagonal
- 1 socket bit holder 1/4"
- 95 L.25mm bits:
- Phillips: 0-1-2(x5)-3
- Pozidrive: 0-1-2(x5)-3
- Square: R0-1-2-3
- Flat: 3-4-4.5-5-5.5-6-6.5-7-8
- Torx: T8-10-15-20-25-27-30-40-45
- Tamperproof Torx: T8-10-15-20-25-27-30-35-40
- Metric hexagonal: H1.5-2-2.5-3-4-5-5.5-6-8
- Hexagonal inch: H1/16-5/64-3/32-7/64-1/8-9/64-5/32-3/16-7/32-1/4
- Tamperproof metric hexagonal: HT2-2.5-3--4-5-6
- Tamperproof hexagonal inch: HT5/64-3/32-7/64-1/8-9/64-5/32
- XZN: M5-6-8
- Tri-wings: TW1-2-3-4
- wrench: SN4-6-8-10
- Clutch: CG1-2-3



OS 3230

32 PCS SCREWDRIVER BIT 1/4" SET

Spare part of OS 3200



Contents:

- 30 screwdriver bits:
- Pozidrive: PZ1, PZ2 (x2), PZ3
- Phillips: PH1, PH2 (x2), PH3
- Slotted: 3, 4, 5, 6
- Hexagonal: H3, H4, H5, H6
- Torx: T10, T15, T20, T25, T27, T30, T40
- Torx tamper: T10, T15, T20, T25, T27, T30, T40
- 1 magnetic socket bit holder 1/4"
- 1 bit holder adaptor for screwers



OM 2338

77 PCS TS-TORX-TORX PLUS SOCKET AND SOCKET BIT SET



Contents:

- 15 Torx socket bits:
T6, 8, 10, 15, 20, 25, 27, 30 1/4" drive
T40, 45, 47, 50, 55 3/8" drive
T60, 70 1/2" drive
- 12 Torx drill socket bits:
T8, 10, 15, 20, 25, 27, 30 1/4" drive
T40, 45, 50, 55 3/8" drive
T60 1/2" drive
- 13 Torx sockets:
E4, 5, 6, 7, 8 1/4" drive
E10, 12, 14, 16 3/8" drive
E18, 20, 22, 24 1/2" drive
- 12 Torx Plus socket bits:
Torx Plus 8, 10, 15, 20, 25, 27, 30 1/4" drive
Torx Plus 40, 45, 50 3/8" drive
Torx Plus 55, 60 1/2" drive
- 13 Torx Plus sockets:
EP4, 5, 6, 7, 8 1/4" drive
EP10, 12, 14, 16 3/8" drive
EP18, 20, 22, 24 1/2" drive
- 12 TS Plus socket bits:
TS Plus 8, 10, 15, 20, 25, 27, 30 1/4" drive
TS Plus 40, 45, 50 3/8" drive
TS Plus 55, 60 1/2" drive



SA 2311

**3/8" SQUARE BIT HOLDER
HEX. 10mm**

Spare part of OS 3600/OM 2330



OS 3254

**BIT HOLDER ADAPTOR 1/4" FOR
SCREWERS**

Spare part of OS 3200/OS 3230



OS 3255

**HEX MALE ADAPTOR
1/4"-1/4" SQUARE L.25mm**

Spare part of OS 3200/OS 3230



HAMMERING TOOLS

OM 0160

RIVOIR HAMMER COMPOSITE HANDLE 1000gr

NEW

Made of C45 steel, curved and polished hits, laterally hardened by electro-induction and sandblasted.

Patented three-component vibration-free handle: nylon, non-slip rubber handle and handle and handle guard, aluminium alloy core. Final mechanical locking with steel wedge and blue epoxy resin.
 Handle length 360mm, with nylon protection sleeve, square strike 44mm 1,5kg
 STANDARD NF E 71-014



Complies with DIN 1195 (for the eye), DIN 1193 (for the tram).



OM 0161

RIVOIR HAMMER ASH TREE HANDLE 1500gr

NEW



Made of C45 steel, curved and polished hits, laterally hardened by electro-induction and sandblasted.

- Specifications:**
- complies with DIN 1195 (for the eye), DIN 1193 (for the tram) and DIN 5111 (for the handle)
 - ash handle length 360mm with nylon protection sleeve
 - square strike 44mm
 - weight: 1,5kg



OM 0170

DEAD BLOW HAMMER WITH INTERCHANGEABLE TIP 32mm

NEW



- Specifications:**
- nylon shore 100+92
 - ash handle
 - length 300mm
 - head length 93mm
 - complies with DIN 1195 (for the eye) and DIN 5111 (for the handle)



SA 1070	2 INTERCHANGEABLE TIPS 32mm POLYURETHANE	Spare part of OM 0170
SA 1073	2 INTERCHANGEABLE TIPS 32mm	Spare part of OM 0170





OM 0540

RUBBER HAMMER 300mm 540g

Specifications:

- handle: wood
- head: rubber Ø57mm
- length: 300mm



OM 0135

ANTI-REBOUND HAMMER 4.5kg L.900mm

Allows HGV wheels to be detached when they have adhered to the hub.



- anti-rebound technology
- plastic handle L.780mm
- head dimensions: L .180xW:105xH:105



OM 0125

FORGED STEEL HAMMER 1250g



Specifications:

- C45 forged steel with HRC50-58 hardness
- chamfered edges
- ergonomic handle with rubber grip
- length: 260mm

Conforms to the DIN 6475 standard



OC 0811

HAMMER + BLOCK SET



OC 0812	PLANISHING HAMMER WITH ROUND FLAT HEAD AND POINTED TIP
OC 0813	PLANISHING HAMMER WITH HORIZONTAL TIP
OC 0814	FINISHING HAMMER ROUND/CROSS-HATCHED SQUARE
OC 0815	BLOCK COMMA 130x55mm
OC 0816	BLOCK RAIL/UNIVERSAL 60X60X56mm
OC 0817	BLOCK CLAW 78x60x27mm
OC 0818	BLOCK ANVIL 80x62x55mm

Contents:

- 3 hammers with GENUINE HICKORY handles L.310mm:
- OC0812: planishing hammer with round flat head and pointed tip
 - OC0813: planishing hammer with round flat head straight tip
 - OC0814: cornering hammer with round and square gridded head

4 blocks:

- OC0815: comma 130x27mm
- OC0816: rail/universal 60x60x56mm
- OC0817: claw 78x60x27mm
- OC0818: anvil 80x62x55mm



OM 0174

BALL PIN HAMMER 440gr



Made of C45 steel, curved and polished hits, laterally hardened by electro-induction and sandblasted.
Ash handle length 350mm with nylon protection sleeve.
BS 876 standard



OM 0581

13 PCS HOLLOW PUNCH SET Ø5-Ø35mm



Contents:

- support for hollow punches
- hollow punches Ø5-6-8-10-11-13-16-19-22-25-28-32-35mm



OM 0580

HOLLOW PUNCH SET Ø3-Ø16mm



Contents:

- Ø3-4-5-6-8-9-10-11-12-13-14-16mm



EG 5033

9 LETTER PUNCH SET DIN 8mm



EG 5031

9 LETTER PUNCH SET DIN 10mm

EG 5032

27 LETTER PUNCH SET DIN 8mm



EG 5030

27 LETTER PUNCH SET DIN 10mm



OM 0258

4 LEVER SET WITH STRIKE DISK

Contents:

- SA0242: lever with strike disk L.200mm
- SA0243: lever with strike disk L.300mm
- SA0244: lever with strike disk L.450mm
- SA0246: lever with strike disk L.600mm





OM 0801
6 PIN DRIVER SET WITH BASE

Ø3-4-5-6-8-10mm
Length: 150mm
Octagonal body
Chrome vanadium steel
Norms NFE 71211, DIN 6450C

NO WARRANTY



OM 0802
5 PUNCH SET WITH INSERTED BLADE

Ø3x125mm
Ø4x150mm
Ø5x165mm
Ø6x180mm
Ø8x200mm

Standards: NFE71211, DIN 7255

NO WARRANTY



OM 0804
4 PCS HGV PUNCH SET

Chrome vanadium steel with ergonomic anti-vibration handle.

Ø10x300mm
Ø12x300mm
Ø14x300mm
Ø16x300mm

Standards : NFE 71211, DIN 7255

NO WARRANTY



OM 0803
AUTOMATIC PUNCH

Spring-loaded trigger lets you punch metal without using a hammer. Use the knob to adjust the impact force.

Length: 143mm
36kg impact force
Chrome vanadium steel, can be resharpened.

NO WARRANTY



OM 0806
MORTICE CHISEL

Standards: DIN 6453

Length: 150mm
Ø12mm
Chrome vanadium steel, can be resharpened.

NO WARRANTY



OM 0810
EXTRA LONG BRASS DRIFT 250X20mm

NEW

NO WARRANTY



Extra flat splitting chisel - Chrome vanadium steel, can be resharpened.

Standards : DIN 5463

OM 0800
EXTRA FLAT SPLITTING CHISEL

Length: 240mm
Width: 26mm
Thickness: 7mm



Norms: DIN 6453

OM 0805
FLAT CHISEL

Length: 300mm
Width: 23mm
Thickness: 13mm

NO WARRANTY





LIFTING & PRESSES

PRESSES

OH 0921

HYDRAULIC PRESS 20T



Protective plexiglass grille to shield the operator



Specifications:

- 2 speed hydraulic pump
- chrome piston with adjusting screw
- plexiglass protection to protect the operator from splinters
- table height adjustable 12 positions
- winch-assisted up and down movement of the table
- 2 oversized pins to hold the table in place
- 159x88x40mm sliding drip tray
- large manometer
- reversible V-shaped support block, including punch kit and protective plexiglass

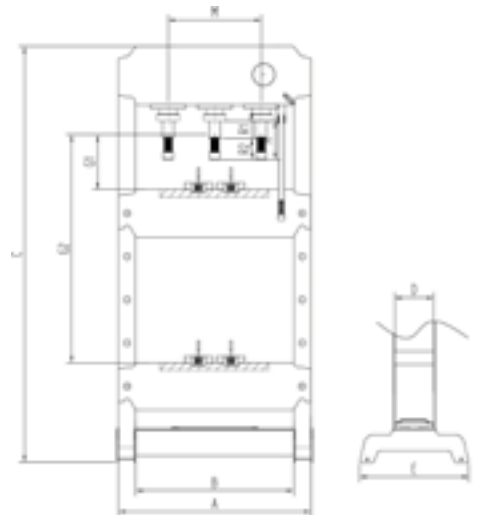

Dimensions												
REF	Capacité Capacity	A (mm)	B (mm)	C (mm)	D (mm)	E (mm)	G1 (mm)	G2 (mm)	R (mm)	R 1 (mm)	R 2 (mm)	M
OH 0921	20T	710	540	1800	134	505	25	850	220	145	75	/





Protective plexiglass grille to shield the operator



OH 0931

DUAL-CONTROL HYDRAULIC PRESS 30T
SLIDING CYLINDER

Max. T **30** WARRANTY **2**

OH 0951

DUAL-CONTROL HYDRAULIC PRESS 50T
SLIDING CYLINDER

Max. T **50** WARRANTY **2**

Specifications:

- 2 speed hydraulic pump
- manual override or hydropneumatic pedal
- chrome piston with adjusting screw
- sliding cylinder jack with handle and rating scale
- plexiglass protection to protect the operator from splinters
- table height adjustable 12 positions
- winch-assisted up and down movement of the table
- 2 oversized pins to hold the table in place
- 226x136x55mm sliding drip tray
- large manometer
- reversible V-shaped support block, including punch kit and protective plexiglass

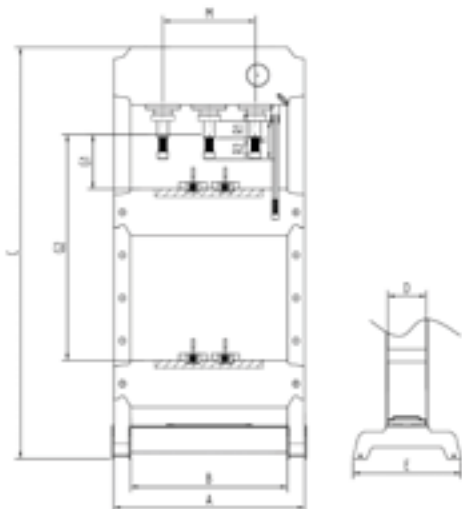

Dimensions												
REF	Capacité Capacity	A (mm)	B (mm)	C (mm)	D (mm)	E (mm)	G1 (mm)	G2 (mm)	R (mm)	R 1 (mm)	R 2 (mm)	M
OH 0931	30T	770	600	1800	148	505	25	850	220	145	75	200
OH 0951	50T	930	750	1900	200	535	80	780	220	145	75	280



- Contents:**
- 8 puncher tools diameter 10-12-16-18-20-22-25-30mm
 - 1 adapter
 - 1 plate
 - 1 storing device

OH 0821

20T PUNCHER TOOLS

Spare part of OH 0820/OH 0921



OH 0831

30T PUNCHER TOOLS

Spare part of OH 0830/OH 0430/OH 0931



OH 0851

50T PUNCHER TOOLS

Spare part of OH 0850/OH 0951



OH 0833

UNIVERSAL 20-30T PRESS SUPPORT STRUCTURE

Accessory of OH 0820/OH 0921/OH 0931/OH 0430/OH 0830/OH 0920/OH 0930

Ensures that the part under the press is stable and held in place.
Allows the height to be adjusted and the part to be precisely positioned.



- Supplied with 5 threaded adjustment/retaining rods:
- 1 rod L.105mm
 - 3 rods L.150mm
 - 1 rod L.190mm



OM 3419

BEARING FORK SEAL INSTALLATION/EXTRACTION KIT



- Contents:**
- 50 kits Ø18 to Ø74mm
 - 1 cup support: 18mm
 - 1 extender: 220mm



CRANES

OH 1001

MOBILE CRANE 1T



NEW

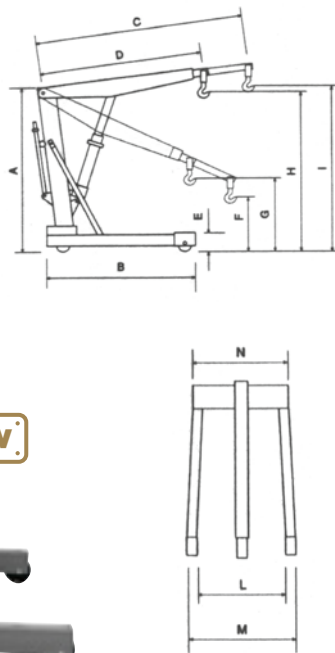

REF	Capacité Capacity	A (mm)	B (mm)	C (mm)	D (mm)	E (mm)	F (mm)	G (mm)
OH 1001	1T	1610	1380	1450	1150	150	380	600

H (mm)	I (mm)	L (mm)	M (mm)	N (mm)	Poids Weight
2220	2450	860	960	965	120kg

Max. T **1** WARRANTY **2**

OH 0238

LOAD BALANCER 680kg



Max. Kg **680** WARRANTY **2**

OH 0009

DRUM GRIP 350kg



Specifications:
 • for steel and plastic drums
 • max. opening 620mm

Max. Kg **350** WARRANTY **2**

OH 1300

500kg HYDRAULIC LIFT TABLE

Ideal for handling parts (boxes, engines, axles...)

Pads and blocks page 166



Specifications:
 • pedal hydraulic lift command
 • dead man-type descent command
 • tray dimensions 1010x520mm
 • 2 fixed wheels and 2 swiveling wheels with protective casing and brakes
 • h. min.: 440mm
 • h. max.: 1575mm

Max. Kg **500** WARRANTY **2**



OH 0335

1T LOW PROFILE FOLDABLE CRANE



Specifications:

- double acting pump
- 360° rotating pump
- deadman lowering control
- 3 positions arm: 1000-750-500kg
- low profile: 85mm
- nylon wheels

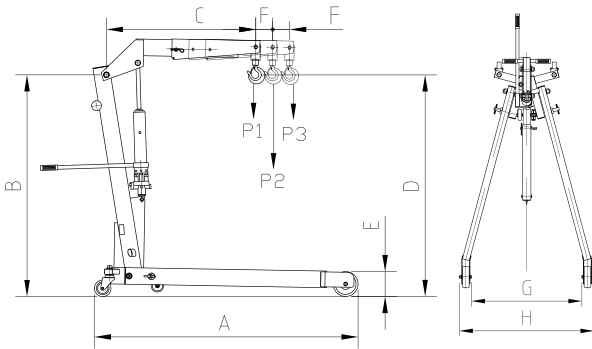

REF	Capacité Capacity	A (mm)	B (mm)	C (mm)	D1 (mm)	D2 (mm)	D3 (mm)	D4 (mm)
OH 0336BL	1T	1610	1440	890	410-1810	340-1890	260-1970	170-2050
OH 0335	1T	1380	1600	1085	245-2330	100-2415	0-2500	-
OH 0338	2T	1977	1977	1290	230-2505	80-2630	0-2705	-

REF	E (mm)	F (mm)	G (mm)	H (mm)	P1 (kg)	P2 (kg)	P3 (kg)	P4 (kg)
OH 0336BL	185	90	700	830	1000	750	4500	250
OH 0335	85	100	865	970	1000	750	500	-
OH 0338	205	150	994	1158	2000	1700	1500	-

OH 0336NBL

1T FOLDABLE CRANE



B.LINE



Specifications:

- lifting capacity: 0-2060mm
- 4 positions arm: 1000-750-500-250kg
- height feet: 185mm
- 6 rotating wheels



OH 0338

2T FOLDABLE CRANE



Specifications:

- deadman lowering control
- double acting pump
- 360° rotating pump
- 3 positions arm: 2000-1700-1500kg
- nylon wheels





JACK STANDS

OM 3002BL

PAIR OF 2T JACK STANDS WITH SECURITY PIN

B.LINE



Specifications:

- min. H.: 278mm
- max. H.: 420mm
- weight: 5.1kg



OM 3030

PAIR OF 3T JACK STANDS WITH SECURITY PINS



Specifications:

- min. H.: 288mm
- max. H.: 425mm
- weight: 6.4kg



OM 3060

PAIR OF 6T JACK STANDS WITH SECURITY PINS



Specifications:

- min. H.: 395mm
- max. H.: 605mm
- weight: 12.9kg



OM 3100

PAIR OF 10T JACK STANDS WITH SECURITY PINS



Specifications:

- min. H.: 468mm
- max. H.: 715mm
- weight: 27kg



OM 3021

JACK STANDS WITH SCREW 20T (x2)



Specifications:

- h. min.: 420mm
- h. max.: 680mm
- base: 315mm-330mm



OM 0684

PAIR OF HEIGHT ADJUSTABLE JACK STANDS 22T



Specifications:

- min. H.: 311mm
- max. H.: 505mm
- base: 280x280mm
- weight: 30.6kg

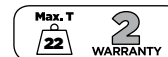

OM 3023

20 T JACK STANDS WITH SCREW HIGH ELEVATION



Specifications:

- h. min.: 665mm
- h. max.: 1170mm
- base: 315mm-330mm



OM 2013

PAIR TALL JACK STANDS 2T



Specifications:

- h. min.: 1050mm
- h. max.: 1850mm

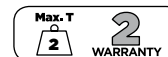

JACKS

OH 4502

BOTTLE JACK 2T

Specifications:

- min. height: 181mm
- max. height: 345mm
- soleplate adjustable from 0 to 48mm
- base: 92x87mm



OH 4504

BOTTLE JACK 4T

Specifications:

- min. height: 193mm
- max. height: 373mm
- soleplate adjustable from 0 to 70mm
- base: 114x114mm



OH 4506

BOTTLE JACK 6T

Specifications:

- min. height: 210mm
- max. height: 415mm
- soleplate adjustable from 0 to 70mm
- base: 114x114mm
- weight: 4.2kg



OH 4512

BOTTLE JACK 12T

Specifications:

- min. height: 230mm
- max. height: 465mm
- soleplate adjustable from 0 to 60mm
- base: 140x126mm
- weight: 7kg



OH 4520

BOTTLE JACK 20T

Specifications:

- min. height: 240mm
- max. height: 455mm
- soleplate adjustable from 0 to 60mm
- base: 159x143mm



OH 4550

BOTTLE JACK 50T



Specifications:

- min. height: 265mm
- max. height: 425mm
- base: 210x176mm
- weight: 25kg



OH 4530

BOTTLE JACK 30T



Specifications:

- min. height: 275mm
- max. height: 440mm
- base: 169x153mm
- weight: 13.3kg



OP 0209

PNEUMATIC FLOOR JACK 2T-2 STAGES

New internal structure to increase stability, internal telescopic guide.

Overload safety feature



NEW

Specifications:

- max. pressure: 7-10bar
- base: 240x240mm
- stroke: 235mm
- min. H.: 350mm
- max. H.: 115mm
- weight: 15kg



OP 0309

PNEUMATIC FLOOR JACK 2T-3 STAGES

New internal structure to increase stability, internal telescopic guide.

Overload safety feature



NEW

Specifications:

- max. pressure: 7-10bar
- base: 272x220mm
- h. min. (without rubber pad and extension): 200mm
- h. max. (without rubber pad and extension): 500mm
- stroke: 300mm



SA 9132

EXTENSION L.80mm

Spare part of OP 0209/OP 0309



Ø pin: 20mm



SA 9131

EXTENSION L.60mm

Spare part of OP 0209/OP 0309



Ø pin: 25mm



OP 0452

EXTRA LONG HANDLE FOR PNEUMATIC JACK

Accessory of OP 0209/OP 0309

Can be installed instead of the handle in a few seconds. When access is difficult it facilitates setting up the jack thanks to its 2 casters. Utilization is also made easier by the offset control box.

Specifications:

- length: 1050mm
- possible inclination: 6°-60°-80°



OH 5302BL

SERVICE GARAGE JACK 2T

B.LINE



Specifications:

- rotating soleplate
- robust chassis
- anti-overload system
- transportation handle
- min. H.: 130mm
- max. H.: 326mm
- handle length: 740mm
- dimensions: 445x205x140mm
- weight: 9.3kg



OH 5304

HYDRAULIC FLOOR JACK 2T 85mm



Specifications:

- rotating saddle
- robust chassis
- safety overload system
- h. min.: 85mm
- h. max.: 381mm
- dimensions: 560x212x145mm
- weight: 12.6kg

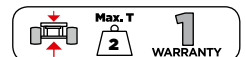

OH 5311

HIGH ELEVATION HYDRAULIC FLOOR JACK 3T

Telescopic head
(+5cm)



Specifications:

- rotating saddle
- robust chassis
- safety overload system
- h. min.: 192mm
- h. max.: 533mm
- dimensions: 635x255x192mm
- weight: 19kg



OH 5306

SERVICE GARAGE JACK 2.25T



Specifications:

- robust chassis
- metered release system for a precise load control
- safety overload system
- swivelling steel saddle
- swivelling rear casters
- h. min.: 140mm
- h. max.: 490mm
- dimensions: 645x345x185mm

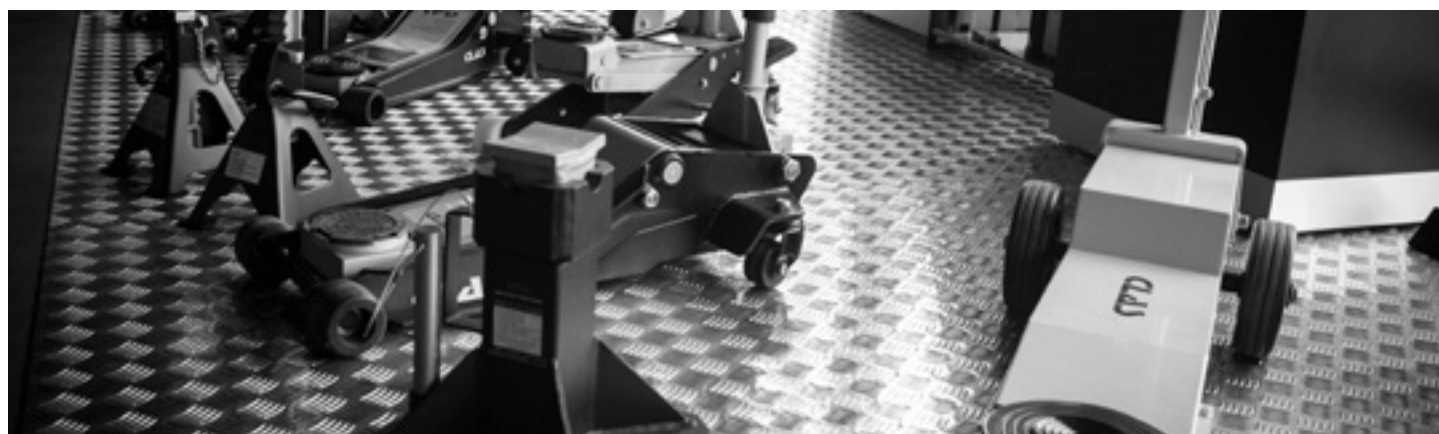

OH 5309

ALUMINUM FLOOR JACK 1.25T 85mm

Ultra light



Specifications:

- rubber pad
- safety overload system
- twin pump design
- protective foam on the handles
- swivelling rear castors
- min. H.: 375mm
- max. H.: 85mm
- weight: 11.5kg
- dimensions: 580x240x150mm



OH 6014

EXTRA LOW PROFILE SERVICE GARAGE JACK 2.5T 75mm



Specifications:

- safety overload system
- magnetic stripe
- swiveling rubber saddle
- fast lifting dual pump system
- nylon wheels
- h. min.: 75mm
- h. max.: 515mm
- dimensions: L.722xW.328xH.150mm
- weight: 33.5kg



OH 5303

GARAGE FOOT PEDAL FLOOR JACK 3T



Specifications:

- foot pedal design
- automatic safety valve prevents jack from overload
- handle locking device
- front and rear polyurethane casters
- swiveling saddle
- h. min.: 145mm
- h. max.: 475mm
- weight: 35.5kg
- dimensions: L.672xW.341xH.180mm

OH 6035

SERVICE GARAGE JACK 3T 95mm

NEW

Dead man type descent



Specifications:

- fast lifting dual pump system
- foot pedal with rubber pad
- anti-overload system
- swiveling rubber soleplate
- nylon wheels
- min. H.: 95mm
- max. H.: 515mm
- dimensions: L.772xW. 367xH.1225mm
- weight: 39.5kg

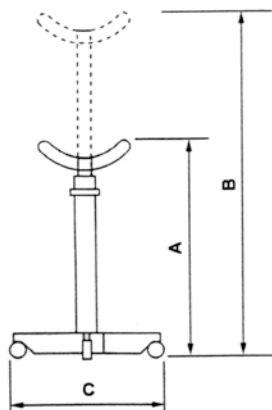

OH 0266

PIT JACK 600kg

Specifications:

- foot control
- chromed rod
- overload safety
- deadman lowering control
- 4 swiveling wheels

Max. Kg
500
WARRANTY
2

OH 0273

PIT JACK 300kg

Specifications:

- foot control
- chromed rod
- overload safety
- deadman lowering control
- 4 swiveling wheels

Deadman lowering control

Max. Kg
500
WARRANTY
2

OH 0235

PIT JACK 1T

Max. T
1
WARRANTY
2

Dimensions					
REF	Capacité (Capacity)	A (mm)	B (mm)	C (mm)	Poids (Weight)
OH 0266	600kg	1180	2000	800	34kg
OH 0272	300kg	1120	1890	800	23kg
OH 0235	1000kg	1140	1990	560	37kg

OH 9150

HYDROPNEUMATIC MOBILE LIFTING COLUMN 1500kg



Specifications:

- 2 swivel wheels to facilitate handling
- safety pin: 5 secure heights
- lifting by the wheel or the car body

SA9151: Lifting under the wheel
Max. working height: 735mm
Min. height: 100mm
Wheel diameter from 480 to 730mm

SA9152: Lifting under the car body
Max. working height: 835mm
Min. height: 140mm

Supplied with hydraulic air pump 10T

Max. T
1.5
WARRANTY
2

OH 5355

LONG CHASSIS SERVICE JACK 5T L.1505mm

Specifications:

- h. min.: 150mm
- h. max.: 560mm
- SA5355: pair of swiveling wheels
- SA5356: pair of front wheels
- weight: 87kg

Max. T
5
WARRANTY
2

OH 5360

LONG CHASSIS SERVICE JACK 10T L.1637mm

Characteristics:

- h. min.: 160mm
- h. max.: 560mm
- weight: 129kg

Max. T
10
WARRANTY
2

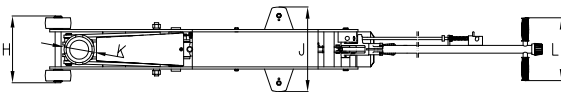
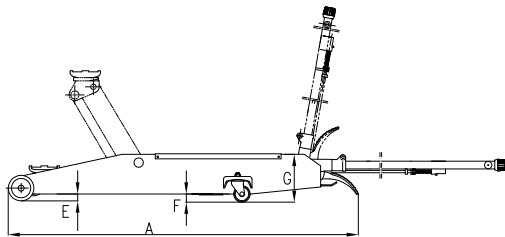

Dimensions											
REF	A (mm)	E (mm)	F (mm)	G (mm)	H (mm)	J (mm)	L (mm)	K (mm)	Long. manche Handle length	Ø roues avant Front wheel Ø	Ø roues arrière Rear caster Ø
OH 5355	1505	31	31	200	290	364	245	130	1155mm	111mm	70mm
OH 5360	1637	24	24	250	333	490	245	150	1155mm	141mm	90mm

OH 9021

AIR HYDRAULIC JACK 15-30T

Carrying handle
Ultra compact



Specifications:

- provides quick and effortless lifts
- safety overload system
- 2 stages: 30T/15T
- equipped with a speed control descent system for enhanced security
- handle: 2 sectionable parts
- foldable handle which becomes a transportation grip- separate controls for utilization with or without the 2nd part of the handle
- angular cutting of the chassis facilitates handling
- min. height: without extension 150mm/with extensions 270mm
- max. height: without extension 289mm/with extensions 409mm
- length: 500mm
- width: 290mm
- extensions: Ø67mm L.45-75mm, ergot Ø25mm
- air pressure: 9-12bar
- weight: 24kg

Applications: Trucks, trailers, buses

Max. T
30
WARRANTY
2

OH 3015N

AIR HYDRAULIC JACK 15-30T

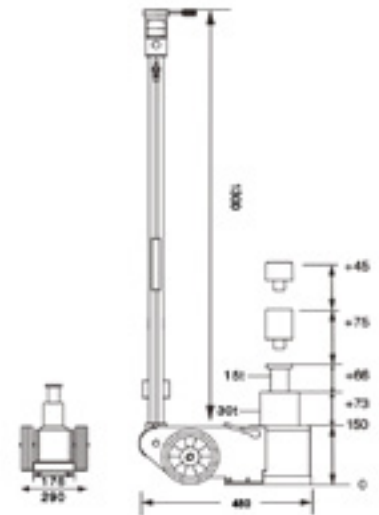

Specifications:

- provides quick and effortless lifts
- safety overload system
- equipped with a speed control descent system for enhanced security
- 2 stages: 30-15T
- long T-handle allows you easily position your jack under the vehicle
- 3 positions: 90-45-0° with metal locking system
- tempered piston for high resistance
- extensions: 45-75mm
- air pressure: 9-12bar
- weight: 38kg



OH 9042N

AIR HYDRAULIC JACK 10-22-40T

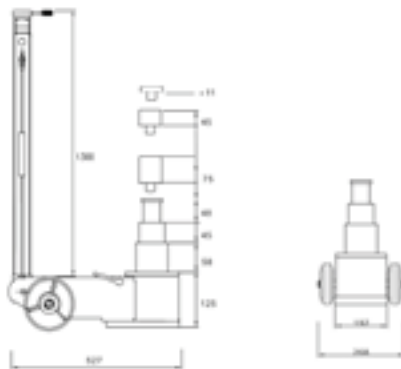

Low profile

Applications: Trucks, trailers, buses, agricultural machinery, civil engineering machinery.

Specifications:

- provides quick and effortless lifts
- safety overload system
- 3 stages : 40-22-10T
- equipped with a speed control descent system for enhanced security
- long T-handle allows you easily position your jack under the vehicle
- 3 positions: 90-45-0° with metal locking system
- tempered piston for high resistance
- h. min.: without extension 125mm/with extensions 256mm
- h. max.: without extension 276mm/with extensions 407mm
- length: 527mm
- width : 268mm
- extensions: 11-45-75mm
- air pressure: 9-12bar
- weight: 36kg



OH 5030N

AIR HYDRAULIC JACK 15-30-50T

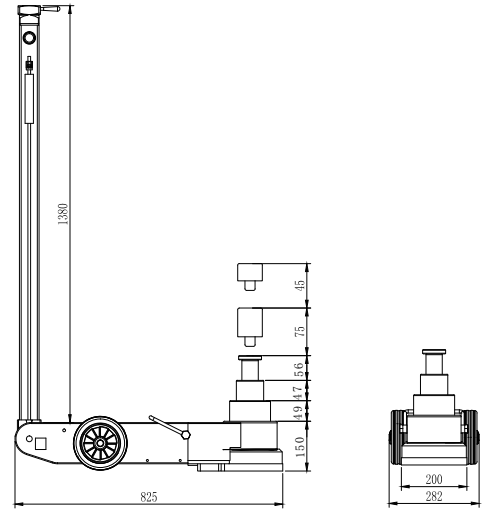

Specifications:

- provides quick and effortless lifts
- safety overload system
- equipped with a speed control descent system for enhanced security
- 3 stages : 50-30-15T
- long T-handle allows you easily position your jack under the vehicle
- 3 positions: 90-45-0° with metal locking system
- tempered piston for high resistance
- extensions: 45-75mm
- air pressure: 9-12bar
- weight: 56kg



OH 9032N

HIGH LIFT AIR HYDRAULIC JACK 30T



Holds full power in high rise

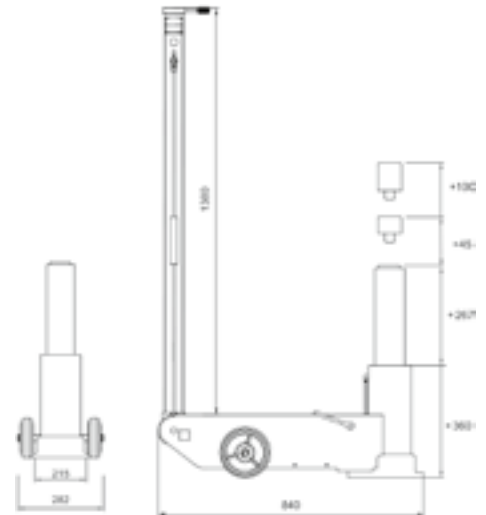

Applications: Civil engineering machinery, agricultural machinery, military machinery, trains.

Specifications:

- provides quick and effortless lifts
- safety overload system
- equipped with a speed control descent system for enhanced security
- long T-handle to ease jack positioning under vehicle
- 3 positions: 90-45-0° with metal locking system
- tempered piston for high resistance
- min. height: without extension 360mm/with extensions 505mm
- max. height: without extension 627mm/with extensions 772mm
- length: 840mm
- width: 282mm
- extensions: 45-100mm
- air pressure: 9-12bar
- weight: 87kg



PADS & BLOCKS

EG 1135

ROUND RUBBER PAD Ø160x28mm

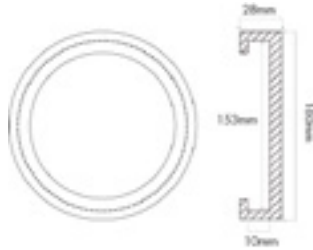

Suitable for Koni,
Romero, Car-o-Liner

Outer diameter 160mm
Inner diameter 150mm
Height 28mm

Rubber SBR 85° SHORE A
Only sold per 4



EG 1139

ROUND RUBBER PAD Ø120x26mm

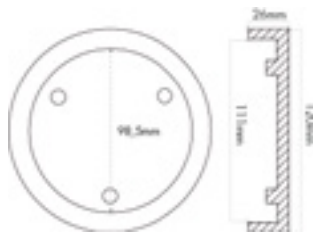

Suitable for Ravaglioli

Outer diameter 120mm
Inner diameter 98.5 & 111mm
Height 26mm

Rubber SBR 80° SHORE A
Only sold per 4



EG 1140

ROUND RUBBER PAD Ø98x21mm

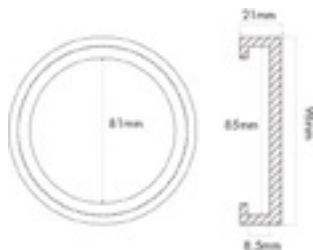

Suitable for Ravaglioli, Sirio,
Space

Outer diameter 98mm
Inner diameter 81 & 85mm
Height 21mm

Rubber SBR 85° SHORE A
Only sold per 4



EG 1141

ROUND RUBBER PAD Ø124x26mm

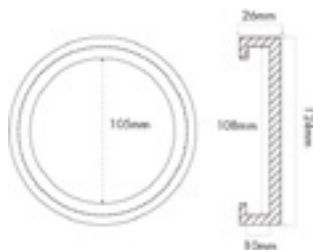

Suitable for ATH,
Ravaglioli, Werther

Outer diameter 124mm
Inner diameter 105 & 108mm
Height 26mm

Rubber SBR 80° SHORE A
Only sold per 4



EG 1142

ROUND RUBBER PAD Ø143x25mm

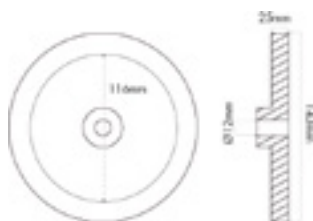

Suitable for OMCN

Outer diameter 143mm
Inner diameter 116mm
Height 25mm
Hole diameter 12mm

Rubber SBR 80° SHORE A
Only sold per 4



EG 1144

ROUND RUBBER PAD Ø147x26mm

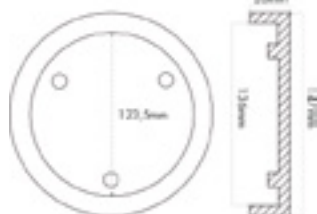

Suitable for Ravaglioli

Outer diameter 147mm
Inner diameter 123.5 & 136mm
Height 26mm

Rubber SBR 80° SHORE A
Only sold per 4



EG 1145

ROUND RUBBER PAD Ø140x27mm

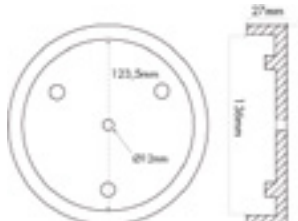

Suitable for OMCN

Outer diameter 140mm
Inner diameter 133mm
Height 27mm
Hole diameter 12mm

Rubber SBR 80° SHORE A
Only sold per 4



EG 1146

REINFORCED ROUND RUBBER PAD (2 METALLIC WASHERS) Ø120x32mm

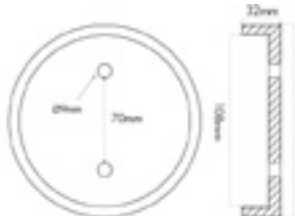

Suitable for Launch, Twin Busch, RP Tools

Øext. 120mm
Øint. 108mm
Height 32mm
Holes Ø9mm hole pitch 70mm

Rubber SBR 80° SHORE A
Only sold per 4



EG 1147

REINFORCED ROUND RUBBER PAD (METALLIC PLATE) Ø125x24mm

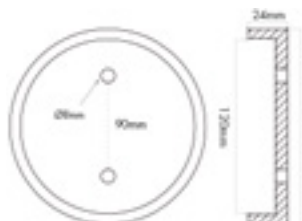

Compatible with Nussbaum, AMI

Øext. 125mm
Øint. 120mm
Height 24mm
Holes Ø8mm hole pitch 90mm

Rubber SBR 80° SHORE A
Only sold per 4



EG 1148

ROUND RUBBER PAD Ø130x10mm



Suitable for Ravaglioli, Siro, Space

Øext. 130mm
Øint. 125mm
Height 10mm

Rubber SBR 80° SHORE A
Only sold per 4



EG 1149

ROUND RUBBER PAD Ø150x10mm



Suitable for Ravaglioli

Øext. 150mm
Øint. 130mm
Height 10mm

Rubber SBR 80° SHORE A
Only sold per 4



EG 1151

REINFORCED ROUND RUBBER PAD (METALLIC PLATE)
Ø120x22mm



Øext. 120mm
Øint. 113mm
Height 22mm
Holes Ø9mm hole pitch 83mm

Rubber SBR 85° SHORE A
Only sold per 4

Compatible with
MAHA



EG 1152

REINFORCED ROUND RUBBER PAD (METALLIC PLATE)
Ø125x26mm



Øext. 125mm
Øint. 120mm
Height 26mm
Holes Ø8mm hole pitch 90mm

Rubber SBR 85° SHORE A
Only sold per 4

Compatible with
SLIFT, IME



EG 0607

LV BLOCK



Hardness 85° SHORE A
Dimensions: L.125xW.77xH.65mm



EG 1150

REINFORCED ROUND RUBBER PAD (1 METALLIC WASHER) Ø120x4mm



Rubber SBR 80° SHORE A
Only sold per 4

Suitable for ATH,
Hofmann, Hermann,
JAB Becker

Øext. 120mm
Øint. 110mm
Height 4mm
Hole Ø9mm

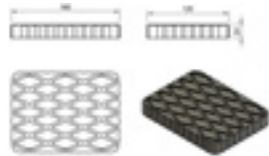
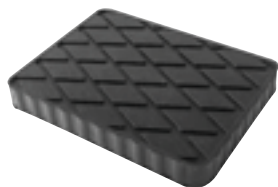

EG 1138

RECTANGULAR RUBBER PAD
160x120x20mm

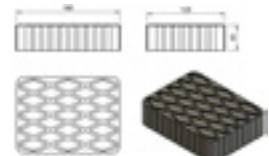

EG 1137

RECTANGULAR RUBBER PAD
160x120x30mm

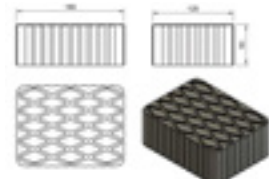
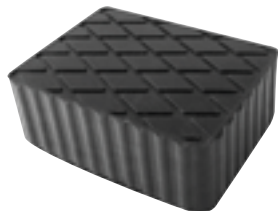

EG 1136

RECTANGULAR RUBBER PAD
160x120x60mm

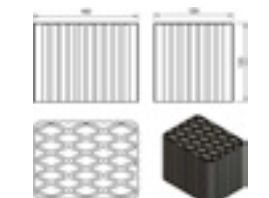

EG 1143

RECTANGULAR RUBBER PAD
160x120x115mm

Hardness 85° SHORE A
Only sold per 4





LUBRICATION & SPILL CONTAINMENT TRAYS



HU 0031

FLUID COLLECTION CONTAINER



- Specifications:**
- dimensions: 780x495x120mm
 - max. wheelbase :920mm
 - equipped with 4 swiveling wheels
 - 2 carry handles
 - pouring spout



HU 0035

HGV AXLE DRAIN PAN

This pan has been designed to collect fluids from HGV axles. When removing a wheel shaft on an industrial vehicle, the oil in the reducers flows onto the rim. This pan has been designed to collect this oil.



- to be placed directly onto the wheel to collect the oil
- suitable for several rim sizes
- with pouring spout



DISTRIBUTION/PUMP

HU 0014BL

METAL TRANSFER PUMP

Pump with a lateral lever, ideal for transferring various types of liquid (non corrosive) such as oil, diesel or kerosene from a standard 200l barrel.



B.LINE



Specifications:

- flow: 20l/min
- extendable tube to reach the bottom of the barrel

NO
WARRANTY

HU 0657BL

MANUAL PRIMING PUMP WITH TAPPET

Manual priming pump, suitable to transfer several kind of liquids (non-corrosive) from a standard 200l drum.



B.LINE



- flow: 18l/min with anti-drip system
- standardized clamping ring
- 1100mm hose
- polyethylene pump

110 cm
NO
WARRANTY

HU 0011

TRANSFER PUMP FOR DRUMS 200L

Side lever barrel pump suitable for pumping various (non corrosive) liquids such as oil, diesel, anti freeze and washer fluid from standard 200l drums.



Specifications:

- viton® seals
- 3 flow positions: 310/330/350 mL by pumping
- extending tube to reach the bottom of drums
- 2 in 1 fixing: Ø59mm thread 200-Ø63 thread 400

2
WARRANTY

HU 0013

ROTARY PUMP SUITABLE FOR ADBLUE

Special pump to transfer AdBlue. Also suitable for other fluids like water, diesel, oil...



Specifications:

- supplied with a 2" bsp fitting
- 0.3 litre per crank turn
- inlet tube 1000mm
- fixing Ø59mm thread 200

2
WARRANTY

HU 0637

0.2l SYRINGE



SA 0637 SEAL KIT FOR 0.2L SYRINGE



HU 0638

1.5l SYRINGE



SA 0636 SEAL KIT FOR 1.5l SYRINGE



HU 0002

2l GRADUATED PITCHER



HU 0005

5l GRADUATED PITCHER



HU 0511

OIL CAN 500ml



HU 0629

FUEL TRANSFER PUMP



Supplied with 130cm transfer hoses



HU 0645 ADAPTER FOR DRUMS M/F Ø55mm

HU 0647 ADAPTER FOR DRUMS M/F Ø70mm



HU 0650

TRANSFER PUMP 12V

Perfect for draining or filling of tank, electro pump useable for diesel, oil, water, cooling liquid transfer...



Specifications:

- power 12V
- flow-rate 50L/min
- hose L.4m 3/4" with filter
- supply cable L.4m
- 25A fuse
- 30min operating cycle



HU 0513BL

FLEXIBLE SPOUT FUNNEL Ø145mm

B.LINE



B.LINE



Specifications:

- funnel Ø145mm with filter (L.153mm)
- flexible spout L.260mm

Funnel with spout and filter.



HU 0514

3 PCS FUNNEL SET Ø165mm

Funnel with flexible spout, filter and hose.



Specifications:

- Ø165mm funnel with filter (L.480mm)
- flexible spout L.350mm
- flexible clear hose 3/8" L.600mm



HU 0620

PNEUMATIC OIL DISTRIBUTOR 24L



Specifications:

- supply for tank discharge: 0.5bar
- level indicator
- trigger with holding in discharge position
- fixed filling funnel, with strainer



HU 0631

FLUID EXTRACTOR/DISPENSER

For motor oil, cooling fluid, brake fluid...
Do not use with flammable liquids



- probe length: 1600mmx3
- Ø6-8-10mm
- manual pump
- pressure/vacuum inverter

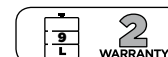

HU 0613

MOBILE OIL DISTRIBUTION BARREL
180-220kg

Contents:

- HU0617: volumetric oil gun 1/2"
- HU0619: pneumatic oil pump + suction tube for 180-220kg drums
- HU0616: 180-220kg drum trolley



HU 0617

DIGITAL VOLUMETRIC GUN 1/2" OIL/ANTIFREEZE



This gun ensures simple, rapid and measured distribution. For oil and anti-freeze.

Specifications:

- variable flow speed: 0-35l/min
- max. pressure: 100bar
- precision: ±0.5%
- swivel connector 1/2"
- automatic anti-drip hose bit L.180mm
- locking handle clip
- 3V 1400mAh battery
- autonomous operation: 8 years / 500,000L



HU 0619N

PNEUMATIC OIL PUMP+SUCTION TUBE FOR 180-220kg DRUMS

Compatible with 180-220kg drums thanks to its 845mm suction plunger equipped with a strainer.

Contents:

- HU0619-1 : 1 x pneumatic oil pump tube for 180-220kg drums
- HU0619-2 : 2 x suction tube for pneumatic oil pump for 180-220kg drums

Specifications:

- maximum flow rate: 12l/min
- ratio: 5:1
- 4m hose included
- supply pressure: 6-8bar



HU 0512

GREASE GUN 500ml

This high pressure grease gun works at 550bar and has an improved plunger for complete grease removal for both cartridge and bulk grease loading.



500ml cartridge



HU 1818

GREASE HOSE REEL Ø8mm 20m 350bar



- epoxy powder coated steel brackets
- stop device every 50cm
- reinforced hose SAE 100R2AT
- hose Øint. 8mm
- length 20m
- max pressure 350bar
- connector 1/4"



Oil collectors
page 208

SPILL CONTAINMENT

HU 0220

SPILL CONTAINMENT TRAY 20L

- dimensions: L.600xW.405xH.155mm
- removable slats

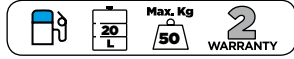

HU 0230

SPILL CONTAINMENT TRAY 30L

- dimensions: L.800xW.400xH.155mm
- removable slats

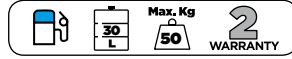

HU 0235

SPILL CONTAINMENT TRAY 60L

- dimensions: L.1000xW.600xH.175mm
- removable slats

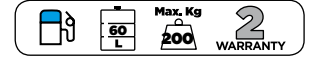

HU 0265

SPILL CONTAINMENT TRAY 100L

- dimensions: L.1200xW.800xH.175mm
- removable slats

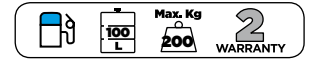

HU 0120

SPILL CONTAINMENT TRAY 110L



- dimensions L.1600xW.800xH.150mm

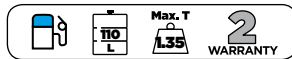

HU 0240

SPILL CONTAINMENT TRAY 230L

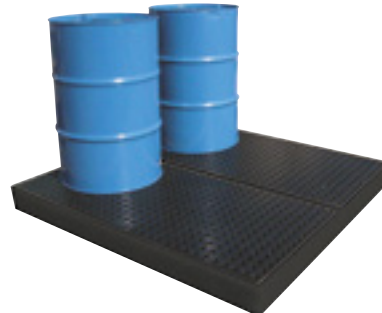

- dimensions L.1600xW.1600xH.150mm

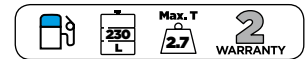

HU 0440

DRUM SUPPORT 220L

For CLAS HU0450 tray

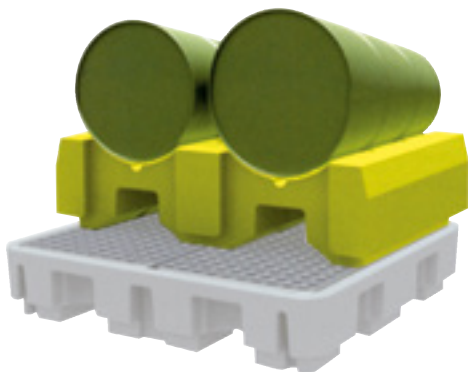

- stores drums flat
- dimensions: L.1375xW.940xH.390mm
- compatible with forklifts and pallet trucks



HU 0121

PLATFORM RAMP

For easy loading

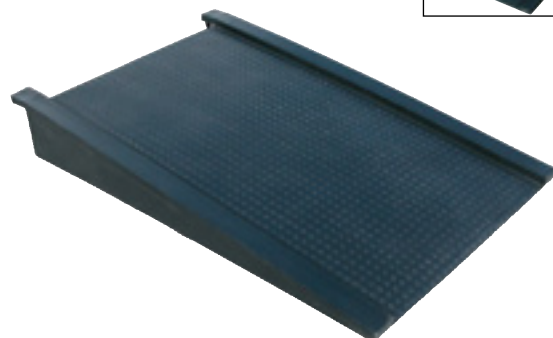
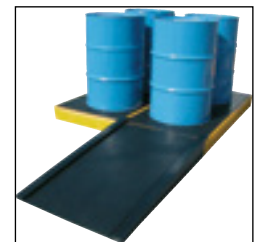

Dimensions: L.1290xW.810xH.180mm



HU 0250

SPILL CONTAINMENT TRAY 250I 2 DRUMS

Spare part of HU 0290

- for 1 or 2 drums
- removable plastic slats
- dimensions:
L.1300xW.750xH.440mm
- compatible with forklifts and pallet trucks

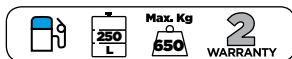

HU 0450

SPILL CONTAINMENT TRAY 480I 4 DRUMS

- for 1 to 4 drums
- removable plastic slats
- dimensions:
L.1380xW.1290xH.480mm
- compatible with forklifts and pallet trucks

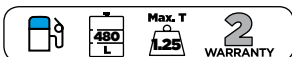

HU 0255

SPILL CONTAINMENT TRAY 1100I

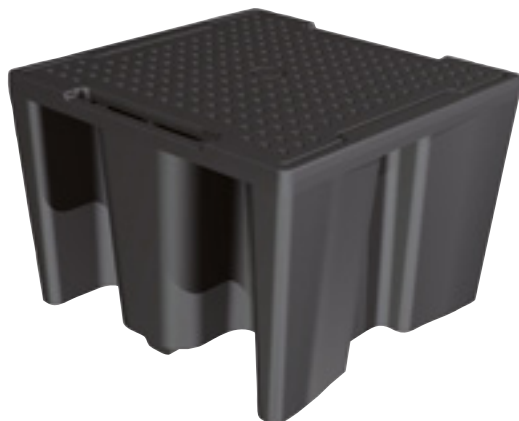

- cubic format (not included)
- dimensions: L.1450xW.1450xH.1000mm
- compatible with forklifts and pallet trucks

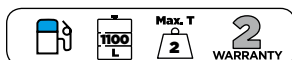

HU 2016

FUNNEL FOR DRUMS 200L



Strainer

- Øint. 545mm
- h.180mm



OH 0009

DRUM GRIP 350kg

Specifications:

- for steel and plastic drums
- max. opening 620mm



HU 0260

SPILL CONTAINMENT TRAY 1100L for 2xIBC

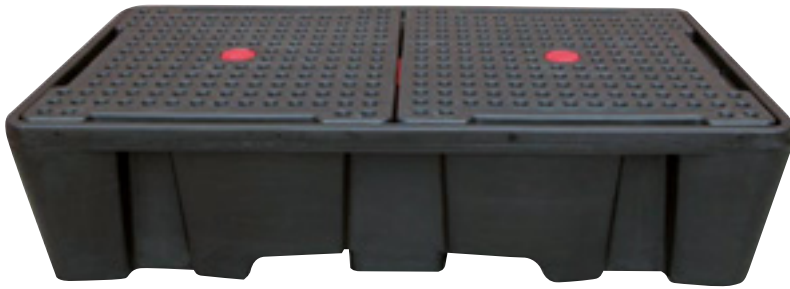

- cubic format (not included)
- removable plastic slats
- dimensions: L.2450xW.1450xH.575mm
- compatible with forklifts and pallet trucks

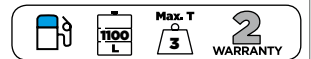

HU 0290

2 SPILL STORAGE SET WITH DRUM 250L

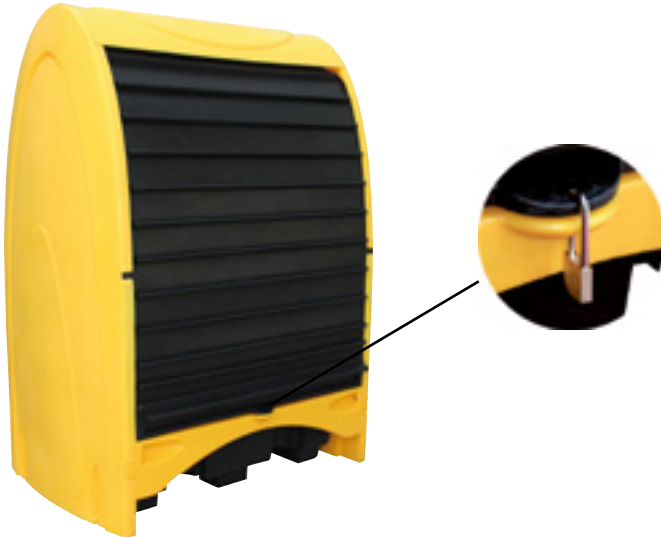

- dimensions: L.995xW.1565xH.2100mm
- storage of chemical products and hazardous waste
- opening on 2 sides

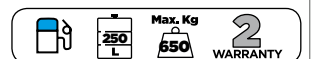

MORE

Extract from article 10 of the decree of February 2, 1998 (France):

I. Any liquid that could pollute the groundwater or soil must be stored within a bund wall with a retention capacity of at least the larger of the following two volumes:

- 100% of the capacity of the largest storage tank,
- 50% of the total capacity of all the storage tanks combined,

(...) For the storage of containers with a unit capacity equal to or less than 250 liters, the retention capacity must be at least:

- In the case of flammable liquids, with the exception of lubricants, 50% of the total capacity of the barrels,
- In other cases, 20% of the total capacity of the barrels, (...)

II. The bund wall must be leak-proof for the substances it may have to contain and resistant to physical and chemical attack by these substances. This must also be the case for its shut-off device, which must be kept closed.

It must be possible to test the leak proofing of the associated tank(s) at any time (...)

Tanks or recipients containing incompatible substances must not be stored within the same bund wall (...)

SOURCE: Ministry of Ecology, Energy, Sustainable Development and the Sea (AIDA, INERIS)





CLEANING VACUUMS

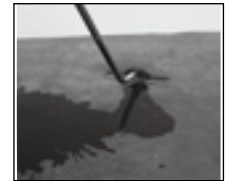

Specifications:

- stainless steel tank mounted on a 4-wheel dolly
- 2 motors of 1000W each
- 80l tank Ø420mm
- drain on 500mm tank
- pressure: 21kPa
- air flow: 108l/s
- sound level: 73dB
- Power supply- 220V 4m cable
- power: 2000W
- dimension (lengthxdepthxheight): 540x595x940mm

EG 0040

DRY AND WET VACUUM CLEANER 2x1000W

Included accessories:

- SA0442: thin tip with connector Ø42mm
- SA0443: Ø60mm brush with connector Ø42mm
- Ø42mm handle with accessory connector Ø37mm
- SA0440: 2200mm flexible hose Ø42mm
- SA0444: Ø37mm scraper
- SA0445: Ø37mm brush length 400mm
- SA0441: cloth filter



SA 0045 600mm FRONT BRUSH ASSEMBLY WITH HOSE

SA 0446 SPIRAL 4000mm Ø42mm

EG 0045

DRY AND WET VACUUM CLEANER 2x1000W+FRONT BRUSH ASSEMBLY 600mm

Included accessories:

- SA0442: thin tip with connector Ø42mm
- SA0443: Ø60mm brush with connector Ø42mm
- Ø42mm handle with accessory connector Ø37mm
- SA0440: 2200mm flexible hose Ø42mm
- SA0444: Ø37mm scraper
- SA0445: Ø37mm brush length 400mm
- SA0441: cloth filter
- SA0045: front brush assembly 600mm with hose



SPRAYERS



- viton® seal
- adjustable nozzle

OC 1501

1.5L RED PRESSURE SPRAYER



OC 1502

1.5L BLUE PRESSURE SPRAYER



EG 0056

WIRE BRUSH

Handy steel wire metallic brush ideal for a multitude of uses.



- carbon steel wire
- soft grip handle



OP 0044

PRO SPRAY GUN



Specifications:

- 2 adjustable jets and air flow
- nozzle L.300mm Ø2mm
- connector 1/4"
- service pressure: 2 to 8bar



OC 1510

1.7L PRESSURE SPRAYER
BRAKE CLEANER

Especially designed for use with brake cleaner.
Wider base for more stability when filling.



Designed for use with
brake cleaner

Specifications:

- viton seals
- adjustable nozzle
- capacity: 1.5l+10%
- graduation: 0.5l-16oz
- graduation dilution 5 and 10
- side relief valve
- expanded Base



EG 1530

RECHARGEABLE SPRAY 650ml

Ideal for lubricants, anti-seize, brake cleaners, air dust cleaning.
Long nozzle for hard-to-reach places.



Specifications:

- aluminium bottle
- 2 in 1 nozzle (fog and jet)
- schrader® pressure type valve
- safety valve 6.3bar



OC 1515

PRESSURE FOAM SPRAYER 11l

Especially designed for a careful bodywork cleanup.
 Nozzle with diffuser allowing a thick foam jet hooking the bodywork.
 Wider base for more stability when filling.
 Manual or pneumatic pressurization.



Foam diffuser

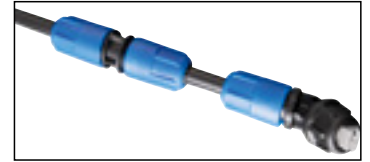

Specifications:

- viton seals
- adjustable nozzle
- capacity: 11,2l
- scale: 1l-0,5Gal
- handle with integrated strainer
- hose L.2m
- lance 110° hose L.57cm
- pressure gauge 0-12bar
- pneumatic pressure connection
- max. pressure: 3bar
- side relief valve
- expanded base with consumable storage compartment

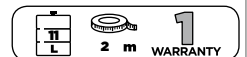

OC 1516

PRESSURE SPRAYER 11l

Especially designed for a careful bodywork cleanup.
 Wider base for more stability when filling.
 Manual or pneumatic pressurization.



Specifications:

- viton seals
- adjustable nozzle
- capacity: 11,2l
- scale: 1l-0,5Gal
- handle with integrated strainer
- hose L.2m
- lance 110° hose L.60cm
- pressure gauge 0-12bar
- pneumatic pressure connection
- max. pressure: 3bar
- side relief valve
- expanded base with consumable storage compartment

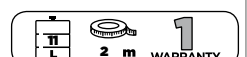

OP 0022

CLEANING GUN



SA 6022 CLEANING SOLUTION

Accessory of OP 0022/OP 0024

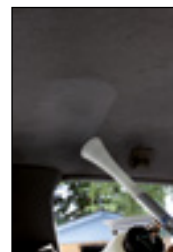

- Cleans bodywork, wheels, dashboard, air vents, engine... and door jambs
- Ultra-low consumption thanks to special vortex technology
- Its vortex propulsion system gives it unbeatable results

Connector supplied

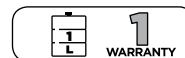

OP 0024

CLEANING GUN EVOLUTION

Use it on seats, air vents, gear shift, wheels, ventilation, registration plates, wheel rims...
Easy to carry and non-cumbersome



SA 6022 CLEANING SOLUTION

Accessory of OP 0022/OP 0024

- encapsulated ball bearing. No rubbing between the bearing and the cone
- reduced wear and tear
- increased efficiency
- improved power
- very fine vaporisation of the liquid for powerful cleaning
- can be used with a solution of water + cleaning solution or water alone

Specifications:

- nozzle rotating speed 4000-8000rpm
- operating pressure 5 to 8 bars
- consumption 180L/min
- bowl capacity 1L
- connector supplied



FOUNTAINS

EG 3521

MOBILE PARTS WASHER



Suitcase format,
waterproof and
transportable



Specifications:

- power switch
- filter
- dimensions: 460x660x260mm

For biodegradable, solvent-free cleansing products.



SA 3521	PUMP
CO 1018	DEGREASING/CLEANING PRODUCT FOR WASHERS 25L

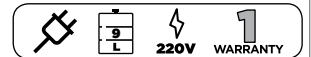

OE 7201

ULTRASONIC CLEANER 9L 200W 40KHz

Specifications:

- heating temperature adjustable from 0 to 80°C
- timer from 1 to 99 minutes
- heating power: 300W
- digital display
- tank drain valve
- external dimensions: 300x240x150mm
- tray dimensions: 330x310x270mm



OE 7200

ULTRASONIC CLEANER 3L 100W 40KHz

Specifications:

- heating temperature adjustable from 0 to 80°C
- timer from 1 to 99 minutes
- heating power: 100W
- digital display
- tank drain valve
- tray dimensions: 240x140x100mm
- external dimensions: 270x240x170mm



SA 7070	TUB OF ULTRASOUND CLEANING SOLUTION 2l
---------	--



CLEANING AGENT

CO 0500

90 CLEANSING WORKSHOP WIPES

Specially designed to clean the hands without rinsing, wiping or residues; the wipes also allow you to clean mechanical parts, tools, workbenches, bodywork, alloy wheels, instrument panels..etc



Double-sided:
Smooth/rough
Gentle for the skin

Specifications:

- double-sided: Smooth-rough
- plant-based solvents with high detergent qualities
- paraben-free
- packed in a bucket with carry grip handle



CO 1027

EXPRESS PAINT REMOVER SPRAY 500ml



Allows paint, varnish and ink pickling on every body repair painted element. Remove burned and imbedded seals (cylinder head, gearbox, water pump, etc).

Applications: Acrylic, Glycerol, Alkyd, Pliolite...



CO 1029

BODY REPAIR DEGREASING/ CLEANING SPRAY 500ml



Degreases and eliminates silicone anti-static

Allows you to degrease and clean bodywork parts before painting or adhesion. Eliminates residues of glue, grease, oil, silicone.



CO 0400

80 CLEANSING MULTI PURPOSE WIPES



CO 1530

5L CONTAINER OF BRAKES CLEANER

Accessory of EG 1530



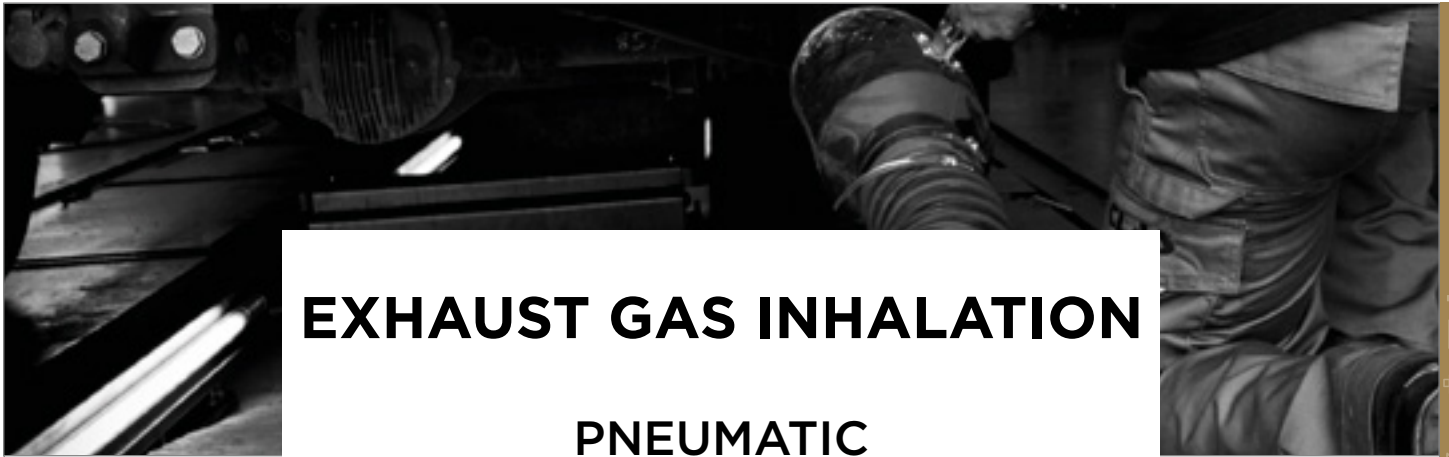

EXHAUST GAS INHALATION

PNEUMATIC

EG 0409

COMPRESSED AIR
POWERED EXHAUST
GAS EXTRACTOR



Connect the extractor to a filtered
non lubricated compressed air line

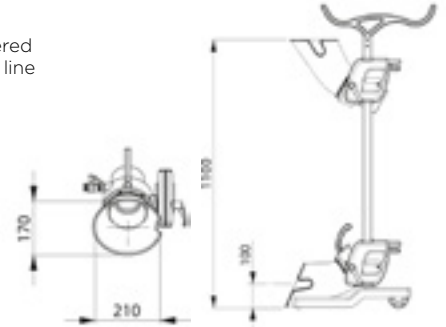

Specifications:

- extractor: 790m³/h
- 6m rubber discharge hose 200°C Ø120mm
- supply pressure 6bar
- minimum supply line Ø10mm



EG 0406

DUAL EXHAUST SYSTEM GAS EXTRACTOR

Accessory of EG 0405

Up to 200°C
Outlet: Ø90mm
Inlet: Ø52mm



EG 0405

EXHAUST GAS EXTRACTOR



Pneumatic exhaust gas extractor that requires 5 to
8bar Ø10mm compressed air supply.

- adjustable height min. 15cm max. 55cm
- inlet Ø130mm
- evacuation hose length 5m Ø75mm, 200°C
- compressed air supply Ø10mm

SA 0411	FILTER	Spare part of EG 0405
SA 0611	Ø80mm EXTRACTION HOSE L6m	Spare part of EG 0405



ELECTRICAL



EG 3200

PORTABLE EXHAUST GAS EXTRACTOR

Specifications:

- aluminum cast fan 0.55kW
- 220V single phase-motor
- turbine rotation 2740rpm
- sound level 76dB
- on/off switch
- steel funnel
- funnel height : mini. 200mm, max. 600mm
- extractor 900m³/h
- back flow hose Ø125mm, length 6m

SA 3200 L3m FLEXIBLE BACKFLOW HOSE Ø125mm Spare part of EG 3200

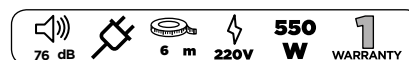

EG 0421

GAS EXTRACTOR REEL Ø100mm 0.75kW

Specifications:

- noise level 74dB
- stop catch
- automatic reel with stop device at end of travel
- metal fan -0.75kW-220V mono
- 10m non-crush rubber hose Ø100mm-200°C
- rubber funnel with CO plug
- extractor 1900m³/h
- discharge: Ø160mm



EG 0422

SINGLE EXTRACTOR GROUP



Specifications:

- aluminum cast fan 0.75kW
- 220V-50Hz single phase
- turbine rotation 2845rpm
- sound level 76dB
- emergency stop button (5m cable before and after stop button)
- 5m non-crush rubber hose
- Ø100mm-200°C
- wall supports
- rubber funnel with CO plug
- extractor 1350m³/h
- discharge: Ø160mm

76 dB IP 44 5 m 220V 750 W 1 WARRANTY

Sold by multiple of 5m



SA 3233	OVAL EXHAUST END (DUAL PIPE) Ø100
SA 3217	METER CRUSH-PROOF 200°C EXHAUST PIPE Ø100mm
SA 3222	EXHAUST END Ø100mm
SA 3231	RUBBER NOZZLE WITH CLIP Ø125mm
SA 3223	METER HIGH TEMPERATURE 500°C EXHAUST PIPE Ø100mm

EG 0423

DOUBLE EXTRACTOR GROUP

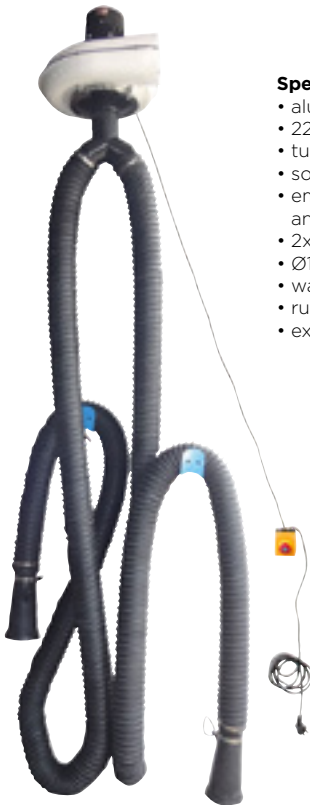

Specifications:

- aluminum cast fan 0.75kW
- 220V-50Hz single phase
- turbine rotation 2845rpm
- sound level 76dB
- emergency stop button (5m cable before and after stop button)
- 2x5m non-crush rubber hoses
- Ø100mm-200°C
- wall supports
- rubber funnel with CO plug
- extractor 1350m³/h

76 dB IP 44 5 m 220V 750 W 1 WARRANTY



EG 0424

MECHANICAL EXTRACTOR REEL GAS HG V



Specifications:

- aluminum cast fan 0.75kW-400V-3 phase
- switch provided
- sound level 76dB
- 10m non-crush rubber hose Ø150mm-200°C
- automatic reel with stop device
- extractor: 1350m³/h
- supplied without flexible back flow hose
- discharge: Ø160mm

76 dB IP 44 10 m 400V 750 W 1 WARRANTY



SA 3219 METER CRUSH-PROOF 200°C EXHAUST PIPE Ø150mm

Spare part of EG 0424/EG 0428 - Accessory of SA 3232

SA 3232 EXHAUST END Ø150mm

Accessory of SA 3219/EG 0424

EG 0428

EXTRACTOR UNIT GAS PORTABLE HG V



Specifications:

- adjustable height 375-750mm (middle's funnel)
- aluminum cast fan 0.75kW
- 220V-single phase
- turbine rotation 2845rpm
- sound level 76dB
- on/off switch
- 6m flexible back flow hose Ø150mm
- steel funnel hose
- extractor 1350m³/h

76 dB IP 44 6 m 220V 750 W 1 WARRANTY





TECHNICAL SOLUTIONS



189

FUEL

- 189 - PLIERS
- 190 - FILTRATION
- 193 - FILLING
- 194 - GPL



195

OIL

- 195 - FILTRATION
- 197 - REPAIR/REBUILDING
- 198 - COLLECTORS/DISTRIBUTORS



200

COOLING SYSTEM

- 200 - CONTROL/MEASUREMENT
- 202 - FILLING
- 203 - PLIERS



204

ENGINE BAY

- 204 - RENAULT/VOLVO
- 206 - IVECO
- 208 - SCANIA
- 210 - DAF
- 211 - MERCEDES/MAN
- 213 - BELT
- 214 - INJECTION
- 225 - CYLINDER HEAD



232

CLUTCH/GEARBOX

- 232 - CLUTCH
- 234 - GEARBOX



240

START & LOAD

- 240 - BATTERY
- 244 - IGNITION/PREHEATING



246

AIRCON

- 246 - CONTROL/MEASUREMENT
- 251 - MAINTENANCE



252

BRAKING

- 252 - CONTROL/MEASUREMENT
- 256 - BLEEDING
- 259 - REPAIR/REBUILDING



266

STEERING/SUSPENSION

- 266 - BALL JOINT
- 268 - STEERING ROD
- 269 - HUB
- 271 - SHOCK ABSORBER

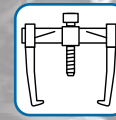

276

EXTRACTION

- 276 - SILENT-BLOCK
- 282 - BEARING
- 284 - HUB
- 284 - DRIVE SHAFT



285

WHEEL

- 285 - REPAIR/REBUILDING
- 286 - SERRAGE/DESSERRAGE

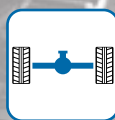

299

WHEEL BALANCERS/TIRE CHANGERS

- 299 - HANDLING
- 300 - TIRE CHANGER
- 310 - WHEEL BALANCER



316

LIFTING RAMPS

- 316 - 2-POST LIFT
- 317 - MOBILE COLUMN LIFT



FUEL PLIERS



OM 0610

3 PLIER SET FOR FUEL LINE CONNECTORS

These pliers can be used on most petrol or diesel vehicles.

Contents :

- 1 green 8mm pliers for GM (OPEL)/FIAT/FORD
- 1 red 8mm pliers for FORD/CHRYSLER and RENAULT with petrol engines
- 1 blue 10mm pliers for FORD/CHRYSLER and RENAULT with diesel engine



OM 9398

FAST FUEL CONNECTORS CLAMP

Specially designed for quickly unplugging connectors and fast connections with 2 buttons laterally accessible (fuel lines, ADblue, depressions, etc.)



Specifications:

- opening: 3 to 32mm
- torque locking system



OM 0504

PETROL AND DIESEL FUEL CONNECTION PLIER



FILTRATION

OM 0316

DIESEL FILTER WRENCH
Ø95mm 14-SIDED



Affectations : Applications:
Man F2000, TGA, TGV



OM 0315

OIL FILTER WRENCH Ø137mm
18-SIDED



Applications: Man



OM 9210

3/8" D. FILTER WRENCH
Ø46mm MERCEDES BLUE-TEC



HU 2027

DIESEL FUEL FILTER REMOVAL KIT OPEL/FIAT/PSA/SUZUKI/SAAB/LANCIA



This removal diesel fuel filter parts was created for removal and replacement of filter element without any risks of harming the filter's plastic body. This housing is not disposable and supplied filter is only a replacement element. This kit is composed with 2 pieces:

- A vice holder for external body of filter to hold it securely
- An adaptor which is positioned on the top of the housing to allow release with a 1/2" square

Applications:

Chevrolet, Citroën, Fiat, Saab, Suzuki, Vauxhall, Opel, Lancia

Engines:

- 1.3 JTD-CDTI-DDIS-MJTD
- 1.9 JTD-CDTI-TID
- 2.0 VCDI-HDI-JTD
- 2.2 JTD-HDI
- 2.3 JTD
- 2.8 JTD-HDI
- 3.0 JTD-HDI



OM 9267

FUEL FILTER WRENCH PSA/
RENAULT 3/8"



Ø108mm



OM 9336

FUEL FILTER WRENCH 3/8" FORD TRANSIT/MONDEO
2.2I TDCI



Specially designed to install and remove fuel filters on Ford Mondeo and Transit 2.2I TDCi >2012.

Does not damage the filter receiver, ensures correct and leak-free reassembly.

Drive: 3/8"



HU 0010BL

**STRAP WRENCH
DEHYDRATING CARTRIDGE**

B.LINE



Length of the strap:
500mm



HU 0008

HGV STRAP WRENCH 1/2"

Do not damage
filters



Specifications :

- max capacity: Ø150mm
- strap L.700mm, largeur 50mm
- drive / 1/2"



HU 0014

**METAL STRAP WRENCH FOR
DESICCANT CARTRIDGE**



- Ø min: 125mm
- Ø max: 140mm
- drive: 1/2"



Affectations :
PSA, Renault

OM 9339

**FUEL FILTER WRENCH Ø109mm PSA/
RENAULT 3/8"**

Specially designed for mounting/removing plastic covers when replacing fuel filters.

Specifications:

- Ø109mm
- 8 pins
- 3/8" drive
- can be tightened with a torque wrench
- doesn't damage the cartridge or its holder
- ensures watertightness



AC 4097

DIESEL STARTING BLEEDING PNEUMATIC KIT

Modern diesel engines need to generate fuel pressures in excess of 2000bar to work efficiently. Air in the fuel line adversely affects engine performance.

When servicing the fuel line and installing a new fuel filter, air gets into the line. Most modern systems incorporate an automatic purger or manual pump permanently installed in the vehicle. However, for many fuel lines, it takes some time to purge all the air in the line.

Modern diesel engines use two main fuel-supply methods:

- positive-pressure feed: this uses an electric pump installed in the fuel tank to push the fuel to the high-pressure pump.
- negative-pressure feed: this uses a motorized vacuum pump to generate a vacuum which draws the fuel to the high-pressure pump.

The tools in this kit have been developed to be connected to diesel fuel lines using the car-maker's connections.



Contents:

- OP0053BL: pneumatic vacuum brake bleeder
- AC4096: diesel starting bleeding kit





AC 4066

REFRACTOMETER

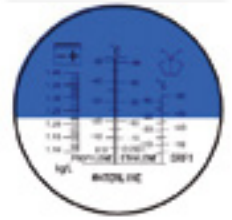

For checking:

- cooling liquid 0 to -50°C
- battery liquid density: 1.1 to 1.4kg/l
- windshield washer liquid 0 to -40°C
- adBlue



AC 0810

ADBLUE + LOW PRESSURE GAUGE SET

Digital pressure gauge, allows the taking of adblue measurements, or all types of fuels.

This version is intended for the following controls:

- pressure adblue PSA, others...
- low fuel pressure

Registration for expertise

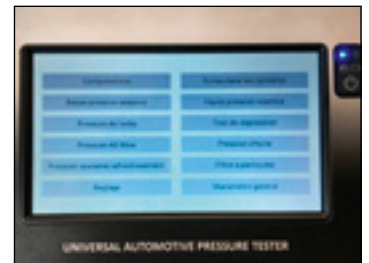

The instrument is equipped with a sound and visual safety device to identify the sensor according to the measurement, the calibration is simple and integrated into the instrument. Clear and precise reading of live values.

Contents:

- 1 TFT color display tester 7" with resistive touch screen
 - battery: lithium polymer 3.7V / 2000mA
 - USB smart battery charging with LED indicator
 - PC connection via USB port
 - ABS case with rubber bumpers
 - all screws are mounted on brass inserts
 - 1/4 thread brass insert at the back to fix the bracket
 - 1 sensor 0-300 bar
 - 4 quick connectors, original manufacturer, extremely flexible
- All components are available at retail

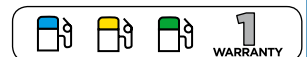

FILLING

HU 0013

ROTARY PUMP SUITABLE FOR ADBLUE

Special pump to transfer AdBlue. Also suitable for other fluids like water, diesel, oil...



Specifications:

- supplied with a 2" bsp fitting
- 0.3 litre per crank turn
- inlet tube 1000mm
- fixing Ø59mm thread 200

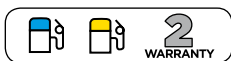

HU 0640

ADBLUE DISTRIBUTION DEVICE

Spare part of HU 0670

- Suitable for all kinds of transfer installations, even those which operate with gravity
- Simple and economical
- Excellent functioning thanks to low flow resistance



Equipped with lever protection with trigger blocking system (can be removed).





GPL

AC 9901

LPG DETECTION KIT

FOR USE IN TECHNICAL INSPECTIONS AND BY LPG SPECIALISTS
 A specially-designed case to detect leaks in LPG vehicles.
 This leak detector has a flexible probe to reach the most difficult places.
 Leaks are indicated by visual and sound signals whose frequency increases closer to the leak: a fast, efficient means of locating leaks with precision.



Contents:

- 1 magnifying glass
- 1 mirror
- 1 mini rechargeable inspection lamp 3W COB+1SMD (OE0395)
- 1x400ml PH neutral aerosol leak detector
- 1 electronic gas leak detector

Meets the latest directives for technical inspections.



OIL FILTRATION

HU 2004

FILTER WRENCH 45-111mm + 3/8" + 1/2" D.-3/8" REDUCER

Allows you to loosen the filters



HU 2006

FILTER WRENCH 122-155mm

Tighten/loosen

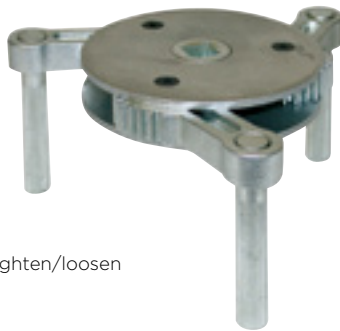

HU 9257

ADJUSTABLE PLIER FOR OIL FILTERS HGV

Ø80 to 190mm



Waist width: 36mm
Drive: 3/8"

HU 2258

FILTER WRENCH OIL/PETROL 3/8" MANN/MAHLE/KNECHT

Specially designed to loosen Mann, Mahle and Knecht filters which have grooves rather than indentations.

Applications:

Mann: W920, W920/7, W930, W930/9, W940, W940/15, W940/20, W940/25, W950, W950/1, W950/5, W962/2, W962/7, W962/14, W1130/1, WK940/4, WK 950/4, WK962/5, WP931, WP962/3
Mahle: OC51, OC83, OC214



HU 2024

DOUBLE-CHAIN FILTER WRENCH Ø60-160mm



HU 2236

FILTER WRENCH Ø107mm 18-SIDED



Models:
Renault: Trafic, Master...



OM 0337

OIL FILTER WRENCH Ø107mm 15-SIDED



Applications:

Renault, Volvo, Iveco, Scania, Claas, Demag, Caterpillar, Perta



HU 1992

IVECO OIL FILTER WRENCH SET



NEW



Contents:

- 91x15
- 96.5x15
- 108x15
- SA2069: 1/2"x3/8" reducer

2
WARRANTY

HU 1999

30 MULTI-BRAND CAP OIL FILTER SET

This oil filter wrench set lets you dismantle immersed filters as well as traditional screwed filters.



3/8" Drive
1/2"-3/8" D. reducer included

Sockets available to retail customers

2
WARRANTY



REPAIR/REBUILDING

HU 2050

OIL SUMP REPAIR KIT WITH PLUGS

This kit is designed for damaged oil sump threading repairs



Contents:

- HU2051: Set of 6 plugs+joints+ tap M13x1.25
- HU2052: Set of 6 plugs+joints+ tap M13x1.5
- HU2053: Set of 6 plugs+joints+ tap M15x1.5
- HU2054: Set of 6 plugs+joints+ tap M17x1.5
- HU2055: Set of 6 plugs+joints+ tap M20x1.5
- HU2056: Set of 6 plugs+joints+ tap M22x1.5

NO
WARRANTY

HU 2019

13 BLOCK DRAIN PLUGS KIT

These plugs eliminate the problem of damaged oil sumps being tapped, as they replace the original plug without any other intervention.

The thread pitch is the same as the original one, but with a larger thread diameter.

Using these drain plugs does not require the thread to be restored, they should be directly mounted.

Each plug includes a second plug.

Once mounted, the first plug is left on the oil tank while the other plug will be used for the next draining.

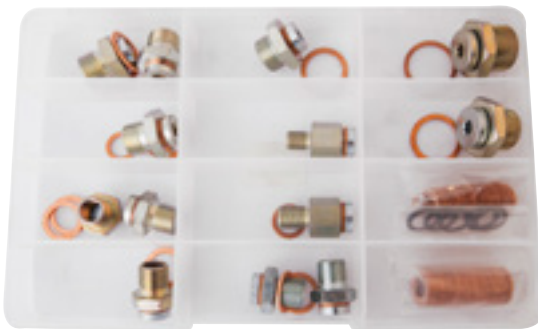
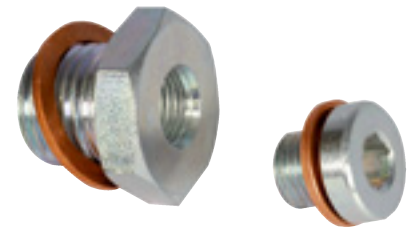

Contents:

- SA2025 plug M10x125 PSA HDI
- SA2024 plug M12x150 Renault/Toyota/Nissan/Mercedes
- SA2023 (x2) plugs M14x125 PSA Diesel and HDI
- SA2022 (x3) plugs M14x150 VW/Audi/Ford/Opel/Mercedes/Fiat JTD
- SA2021 (x3) plugs M16x150 PSA/Renault/Volvo
- SA2020 plug M18x150 PSA/Renault/Volvo/Toyota/Mitsubishi
- SA2019 plug M20x150 Fiat/Alfa/Lancia
- SA2018 plug M22x150 PSA/Fiat
- 25 copper sealing joints: Ø10mm, 16x1.5
- 5 rubber joints Ø1/4"
- 20 copper joints Ø12mm, 16x1.5

Plugs and joints available retail also.

NO
WARRANTY

HU 2002

3/8" DRAIN BIT SET

Suitable for draining differentials, axles and gearboxes.



Contents:

- hex: 8-9-10-12-14-17mm
- 3-sided: 10mm
- XZN tamperproof: 16mm
- square: 7-8-10-11-12-13-14-5/16"-3/8"
- square female: 10mm

NO
WARRANTY



COLLECTORS/DISTRIBUTORS

HU 0079BL

70L GREY WASTE OIL DRAINER



B.LINE



Specifications:

- capacity: 70l
- air pressure for oil discharge: 1 to 2 bar
- standard: tool plate+stand for scroll
- 4 wheels (2 swivel wheels)
- min height: 1005mm
- max height: 1610mm
- Total container capacity: 620mm
- Ø tray: 420mm



HU 0180N

80l WASTE OIL DRAINER



Specifications:

- capacity: 80l
- drain pressure : 0.5bar
- 4 wheels including 2 directional
- h. min.: 1200mm
- h. max.: 1795mm
- oil level indicator
- tray Ø: 520mm

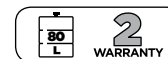

HU 0149N

80l MIXED WASTE OIL DRAINER



Specifications:

- gravity draining
- vacuum draining
- air inlet pressure: 6 to 8bar
- Ø tray: 520mm
- air pressure for oil discharge: 0.5bar
- oil level indicator
- h. min.: 1210mm
- h. max.: 1795mm

Supplied with flexible and rigid probes (shank Ø: 12.2mm)



HU 0159N

80l MIXED WASTE OIL DRAINER WITH BOWL



Specifications:

- transparent pre-chamber with level indicator
- 1.5m suction hose with valve and quick connect for probes
- gravity draining
- vacuum draining
- air inlet pressure: 6 to 8bar
- Ø tray: 520mm
- pre-chamber capacity: 9l
- air pressure for oil discharge: 0.5bar
- oil level indicator
- h. min.: 1350mm
- h. max.: 1795mm

Includes flexible and rigid probes



**HU 0620****PNEUMATIC OIL DISTRIBUTOR 24L****Specifications:**

- supply for tank discharge: 0.5bar
- level indicator
- trigger with holding in discharge position
- fixed filling funnel, with strainer

NEW**HU 0631****FLUID EXTRACTOR/DISPENSER**

For motor oil, cooling fluid, brake fluid...
Do not use with flammable liquids



- probe length: 1600mmx3
- Ø6-8-10mm
- manual pump
- pressure/vacuum inverter

**HU 0139****24L SUCTION DRAINER**

Supplied with flexible and rigid probes

**Specifications:**

- venturi design
- air inlet pressure: 6 to 8bar
- air pressure for oil discharge: 0.5bar
- oil level indicator

**HU 0033****65I HGV FLUID COLLECTION CONTAINER**

For HGV ground draining.
For engine oil, gearboxes...



- equipped with a breakwater grid and anti-drain back
- dimensions: 250x700x500mm

**HU 0114****65I HGV PIT COLLECTOR**

For engine oil, gearboxes...



- equipped with a breakwater grid and anti-drain back
- drain valve underneath the tank
- waist width adjustment: 750mm mini, 1200mm maxi
- dimensions: 250x700x500mm



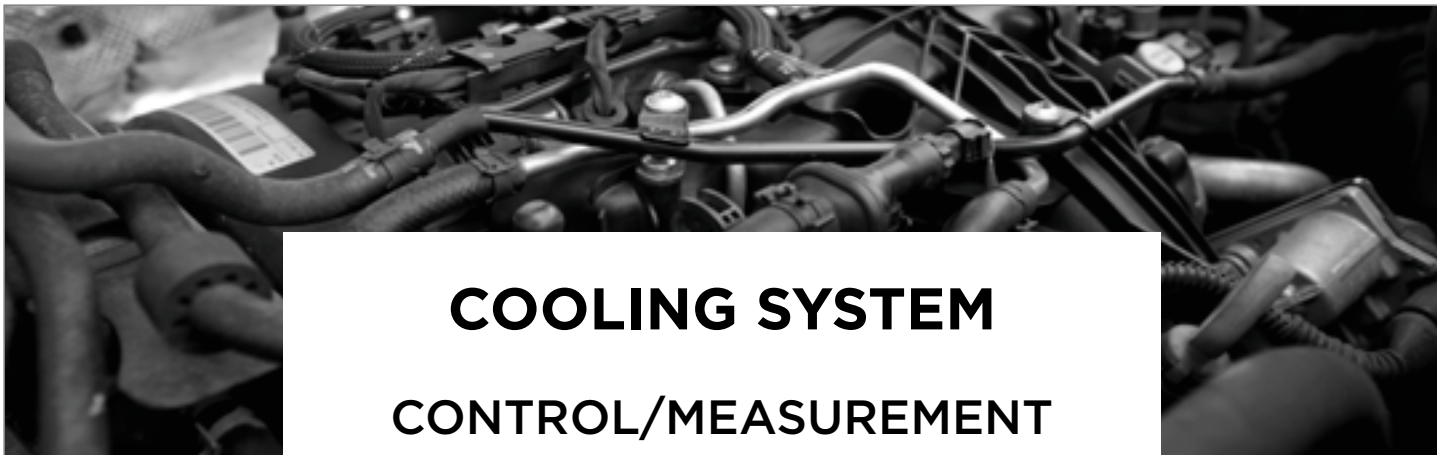

COOLING SYSTEM CONTROL/MEASUREMENT

AC 1002

HGV COOLING LINE TESTER SET

Allows simple and quick control by pressurizing the cooling circuits by connecting instead of the expansion tank cap.



NEW

Contents:

- 5 metal plugs with quick coupling
- pressure regulator with relief valve
- control manometer 0 to 5bar
- vacuum filling kit
- 3 conical filling adapters
- filling pressure gauge -1 to 0bar
- filling pipes with strainer

Applications: Volvo, GM, Kenworth, Peterbuilt, Freightliner

2
WARRANTY

OH 8006

BUSES RADIATOR CRANE

Specifically designed for dismantling radiators on buses.



NEW

Specifications:

- lifting height: 1890mm
- 4 wheels including 2 braked castors

Max. T
90
2
WARRANTY

AC 4066

REFRACTOMETER

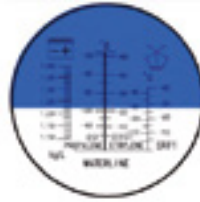

For checking:

- cooling liquid 0 to -50°C
- battery liquid density: 1.1 to 1.4kg/l
- windshield washer liquid 0 to -40°C
- adBlue



AC 3300

CO2 DETECTION KIT



- checks for gas combustion in the radiator
- the test fluid changes colour if a leak is detected
- fast identification of defective head gasket

1- with the engine hot, take off the radiator cap or the expansion-tub cap and pour in the indicated dose of the tracking fluid.

2- Put the bulb on the tube and squeeze it several times. Any gas in the cooling system mixes with the tracking fluid. The blue tracking fluid changes color (turns yellow) if there is an internal combustion fault that forces CO2 into the cooling fluid. Conclusion: problem with the cylinder head gasket.



AC 3350 CO2 DETECTION FLUID



Exclusive gel formula with flakes of aluminum incorporated

Treats 4 to 8L of liquid.

CO 1012

RADIATOR LEAK SEALER 300ml

Plugs leaks in the coolant circuit, ensures the radiators and water pumps are leakproof and avoids overheating.

Allows almost the full circuit to be repaired. This product, which is composed of gel and aluminum flakes, permits you to carry out repairs by creating a patch on non-rigid parts (water container, hoses..) and the aluminum flakes repair the radiator by sealing the leak using the flakes.



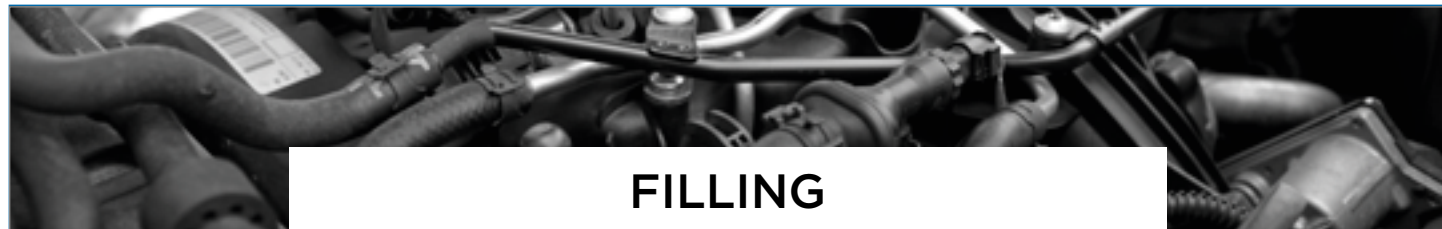

FILLING

AC 1104

COOLING LINE FILLING DEVICE

Pressure loss system that forces rapid total refilling of the circuit.
Compressed air is used to empty the system.
Supplied with 4 rubber bushes Ø30-35-39.5-44mm (expanding) suitable for radiator caps from Ø31mm to 52mm.
The tool requires the system to have been previously emptied.



2
WARRANTY

HU 4029

CONNECTION DRAIN AND COOLING CIRCUIT FILLING SCANIA



2
WARRANTY

PLIERS

Pinch brakes hoses, fuel, heating, cooling, etc.
Perfect for hard-to-reach areas



OM 5105

3 HOSE CLAMP SET

Permettent de pincer les durites de freins, carburant, chauffage, refroidissement, etc.

OM 5010	HOSE CLAMP Ø6-Ø19mm
OM 5020	HOSE CLAMP Ø12.5-Ø32mm
OM 5030	HOSE CLAMP Ø19-Ø57mm

OM 5104

SET OF 3 L-SHAPED HOSE CLAMP

OM 5014	L-SHAPED HOSE CLAMP Ø15mm
OM 5024	L-SHAPED HOSE CLAMP Ø22mm
OM 5044	L-SHAPED HOSE CLAMP Ø42mm

Specifications:

- 90° elbow



Opening: 80mm

OM 9390

UNIVERSAL CRIMPING PLIER FOR HGV

Tool remotely operatable by cable, for installing/ removing the entire range of self-tightening elastic clamps Ø18 to 54mm, even in difficult places to reach.



OM 9389

PLIER FOR CLAMPS WITH DOUBLE GRIP

This multidirectional plier facilitates the removal of self-tensioning clamps (water, fuel, air) which are not easy to reach.



Specifications:

- opening/closing of clamps horizontally or vertically without adjustment
- opening: 70mm
- non-slip handles



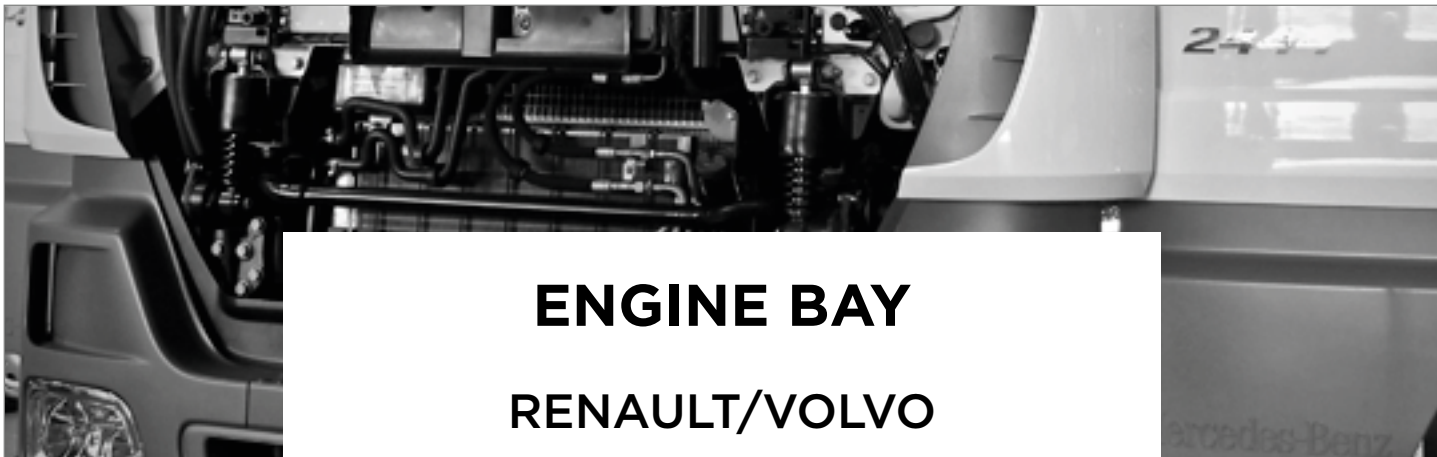

ENGINE BAY

RENAULT/VOLVO

OM 0328

FLYWHEEL ROTATOR TOOL FOR RENAULT MAGNUM ENGINES



OM 0327

FLYWHEEL ROTATOR TOOL FOR RENAULT/VOLVO ENGINES



Suitable for Volvo MP8/MP10, FH, D13A520 and Renault DCI-DXI engines (Mechanical gearboxes) OEM 88800014



OM 0325

FLYWHEEL ROTATOR TOOL FOR VOLVO ENGINES



OM 0326

FLYWHEEL ROTATOR TOOL FOR RENAULT/VOLVO ENGINES



Suitable for D9A, D12, D16C, DXi optidriver engines OEM 9996956



OM 0150

INSTALLATION AND REMOVAL ROCKER ARM RAMP TOOL RENAULT/VOLVO 9-12-16L



OM 3685

CABIN SHOCK ABSORBERS ASSEMBLY/DISASSEMBLY PACK

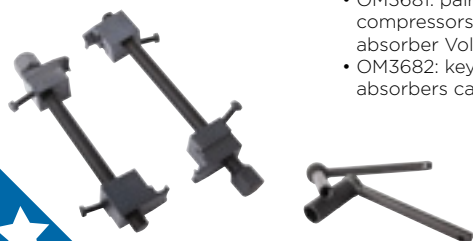

Contents:

- OM3681: pair of spring compressors cabin shock absorber Volvo/Renault
- OM3682: key assembly nut shock absorbers cabin Volvo/Renault



OM 0112

MOUNTING GUIDE CYLINDER SET VOLVO/RENAULT 11-12-13-16L



OM 6100

MASTER TIMING TOOL SET RENAULT/NISSAN/OPEL/VOLVO

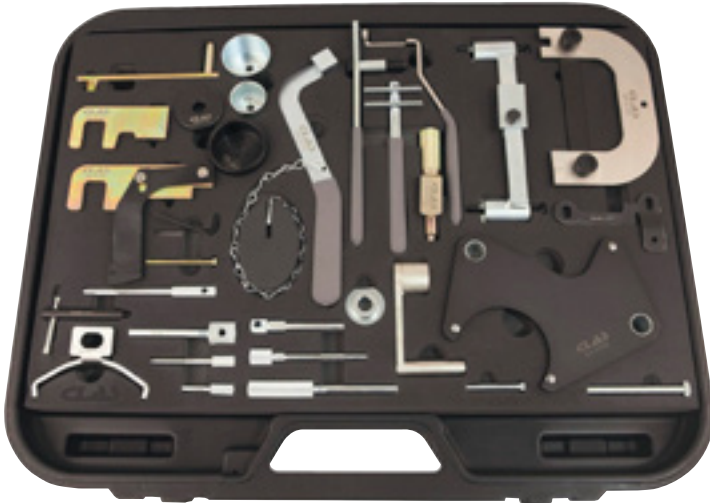

Models:

Renault: Clio 1-2-3-4, Clio Sport 1-2-3, Mégane 1-2-3, Master 1-2, Mégane Scénic 1-2-3, Vel Satis 1-2, Avantime, Kangoo 1-2-3, Laguna 1-2-3, Espace 1-2-3, Trafic 1-2, Wind, Modus, Twingo, Koleos

Dacia: Logan, Duster, Sandero, Dokker

Nissan: Note, Qashqai, Micra, Interstar, Primastar, Kubistar, Almera, Primera

Opel: Vivaro, Movano

Volvo: S 40, V 40

Engines: 1.2, 1.2 16V, 1.4, 1.4 16V, 1.5 DCI, 1.6, 1.6 16V, 1.6 D, 1.7, 1.8, 1.8 16V, 1.9 TD, 1.9, 1.9 DCI, 1.9 DTI, 1.9 CDTI, 2.0, 2.0 16V, 2.1 TD, 2.2, 2.2 DCI, 2.2 DTI, 2.2 TD, 2.5 DCI, 2.5 CDTI, 2.5 TD, 2.8 D

OEM codes:

D4F702/706/708/712/714/716/722/728/730/740/764
 D7F700/701/710/720/722/726/730/744/746/764/766
 E7F700/704/706/750
 E7J601/624/626/634/635/680/700/706/710/711/716/718/719/720/724/726/728/740/742/745/754/756/757/764/770/771/773/780
 F3P670/682/700/704/706/708/710/712/714/720/724/755/758/760
 F7P704/722
 F3R611/722/723/728/729/750/751/752/791/796/797/798
 F5R700/701/740
 J7R732/733/734/735/768
 F7R710/714
 J7T600/760/761/762/766/772/780/782
 N7Q704/710/711
 N7U700/701
 K4J700/710/711/712/713/714/715/730/732/740/750/770/780
 K4M700/701/704/706/707/708/709/710/711/712/714/716/718/720/724/730/732/734/736/740/742/743/744/745/746/748/750/752/753/754/760/761/762/764/765/766/768/776/782/788/790/791/794/800/801/802/804/812/813/830
 K9K700/702/704/706/710/712/714/716/718/722/724/728/729/732/734/740/750/752/760/762/764/766/768/802/804/806
 F9Q610/650/664/670/674/711/716/717/718/720/722/730/731/732/733/734/736/738/740/744/748/750/752/754/758/759/760/768/762/770/772/774/780/782/784/786/788/790/796/800/803/804/808/812/816/818/820
 G9T600/605/700/702/703/706/707/710/712/720/722/742/743/750
 G9U720/724/726/730/750/754
 F8M736/760
 F8Q600/610/606/620/622/624/630/632/640/644/646/648/662/672/678/680/682/684/692/696/706/714/720/722/730/732/740/742/744/764/768/706/776/784/786/788
 J8S620/621/622/758/760/776/778
 G8T714/716/740/752/760/790/792/794
 S8U720/722/730/731/742/748/750/752/770/772/780/782
 S9U700/702/704/714/740
 S9W700/702/206/208/212
 E5F, E6J, K7M, F4P/F4R, F1N, F2N, F3N, F2R, F3P, F4P, F3R, J5T, J6R, J7R



OM 3674

TIMING TOOLS RENAULT/OPEL/NISSAN/SUZUKI DCI



Models:

Renault: Clio, Kangoo, Laguna, Espace, Master, Mégane/Scénic, Trafic

Nissan: Kubistar, Interstar, Qashqai

Opel: Vivaro, Movano

Suzuki: Gran Vitara

Engines: 1.5 DCI, 1.9 TD, 1.9 DCI, 2.2 DCI, 2.5 DCI

OEM codes:

K9K 700, K9K 704, K9K 706, K9K 710, K9K 712, K9K 714, K9K 716, K9K 718, K9K 722, K9K 724, K9K 728, K9K 729, K9K 732, K9K 734, K9K 734, K9K 750, K9K 752, K9K 760, K9K 762, K9K 764, K9K 766, K9K 768, K9K 790, K9K 792, K9K 830, K9K 832, K9K 834, K9K 836, F9Q 650, F9Q 660, F9Q 664, F9Q 670, F9Q 674, F9Q 680, F9Q 690, F9Q 740, F9Q 746, G9T, G9U



OM 3686

TIMING TOOL RENAULT/NISSAN/OPEL 1.6-2.0-2.3 DCI-CDTI



Models:

Renault: Megane, Scenic, Laguna, Latitude, Fluence, Espace, Trafic, Koleos, Vel Satis

Nissan: Primastar, Qashqai, X-trail, NV 400

Opel: Vivaro, Movano

Engines: 1.6, 2.0, 2.3 DCI et CDTI

Engine codes: M9R





IVECO



OM 0157

GEARBOX AND DISTRIBUTION SHAFT MOUNTING GAUGE IVECO 10L



OM 0158

GEARBOX AND DISTRIBUTION SHAFT MOUNTING GAUGE IVECO 13L

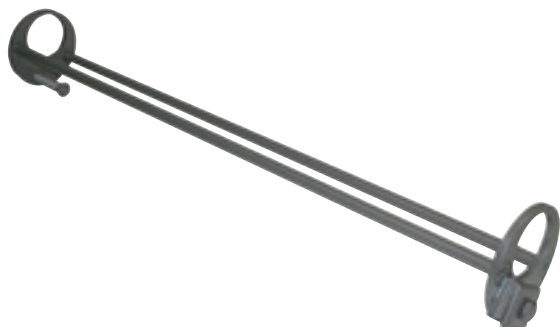

OM 0151

INSTALLATION AND REMOVAL ROCKER ARM RAMP TOOL IVECO 8L



OM 0152

INSTALLATION AND REMOVAL ROCKER ARM RAMP TOOL IVECO 10-13L



OM 0339

FLYWHEEL ROTATOR TOOL FOR IVECO ENGINES

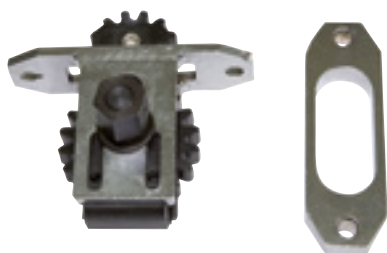

Suitable for 8360.46/F3A/F3B engines
Specific for Eurocargo/Cargo 150E27R/FPR
320E27T/PT Eurotech/Eurostar



OM 0340

FLYWHEEL ROTATOR TOOL FOR IVECO ENGINES

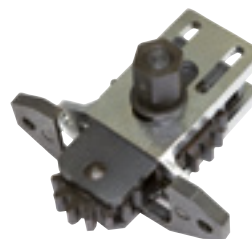

Engines 8040-25-45/9060-25-45/8210.42/8260/8280/190.38/190.42
Specific for Eurocargo/Cargo /Eurotech/
Heavyon/OffRoad/Bus



**OM 4025****TIMING TOOLS FIAT 2.3 JTD**

Models: Ducato, Iveco, Daily
Engines: 2.3 JTD, 3.0 JTD, 3.0 HPI

OEM codes:
 F1AE0481C, F1CE0481D, F1AE0481A, F1AE0481B, F1CE0481A

**OM 0521****CRANKSHAFT FRONT SEAL INSTALLATION TOOL IVECO/
ASTRA 10-11-13-16L****Specifications:**

- seal (MVQ) silicone rubber
- Øext. 130mm
- Øinn. 100mm
- thickness 12mm

Engines: F3A/F3B

Models: IVECO Eurostrar, Eurotech MP, Eurotrakker, Stralis, Trakker, ASTRA HD7-C and HD8

**OM 0522****CRANKSHAFT REAR SEAL
INSTALLATION TOOL IVECO/
ASTRA 10-13L****OM 0525****CRANKSHAFT REAR SEAL
INSTALLATION TOOL IVECO
EUROCARGO 1-3****Specifications:**

- PTFE seal
- Øext. 155mm
- Øinn. 130mm
- thickness 16mm

Engines: F4A, N40, N45, N60
Models: IVECO Eurocargo 1-3, Eurofire, Tector, Vertis

**OM 0523****CRANKSHAFT FRONT SEAL INSTALLATION TOOL
IVECO STRALIS 10L (F2C)****Specifications:**

- FPM seal (fluor rubber)
- Øext. 160mm
- Øinn. 130mm
- thickness 14mm

Engines: F3A/F3B/F2C

Models: IVECO Eurostrar, Eurotech MP, Eurotrakker, Stralis, Trakker, ASTRA HD7-C and HD8

**OM 0527****CRANKSHAFT REAR SEAL INSTALLATION
TOOL IVECO DAILY/FIAT DUCATO****Dimensions:**

- Øext. 113mm
- Øinn. 83mm
- thickness 14mm

Engine: F1A 2.3l

**OM 4052****IVECO AIR-CONDITIONING ELASTIC BELT
MOUNTING TOOL**

Requires a second operator to rotate the engine.

Applications: IVECO Cursor





SCANIA



OM 0492

CRANKSHAFT REAR SEAL
INSTALLATION TOOL SCANIA Ø175mm

Engines: 8.9l PDE, 9.3l PDE, 10.6l PDE, 11.7l PDE, 11.7l HPI, 15.6l PDE,
serie 4, serie S, serie 520
For seal ref OEM 1433183



OM 0493

CRANKSHAFT REAR SEAL
INSTALLATION TOOL SCANIA Ø185mm

Engines: 8.9l PDE, 9.3l PDE,
10.6l PDE, 11.7l HPI, 15.6l PDE

For seal inner Ø 145mm

OM 0494

CRANKSHAFT REAR SEAL INSTALLATION
TOOL SCANIA Ø175-185mm

Engines: 8.9l PDE, 9.3l PDE, 10.6l PDE, 11.7l PDE,
11.7l HPI, 15.6l PDE
OEM ref for seal Ø175: 1433183

OM 0491

CRANKSHAFT FRONT SEAL INSTALLATION
TOOL SCANIA 12L Ø119



Engine: 11.7l



Dimensions:
Øext. 159.5mm
Øinn. 140.5mm
Thickness 7.7mm

Engines: 9-11-12l
Injection PDE/HPI



OM 0481

CRANKSHAFT FRONT SEAL
INSTALLATION TOOL SCANIA
9-13L Ø119mm



Engines: 12.7I XPI



OM 0482

CRANKSHAFT FRONT SEAL
INSTALLATION TOOL SCANIA
Ø149mm



Engines: 12.7I XPI second generation



OM 0483

CRANKSHAFT FRONT SEAL
INSTALLATION TOOL SCANIA
Ø119-138mm



Engines: 15.6I PDE, 16.4I XPI second generation



OM 0484

CRANKSHAFT REAR SEAL INSTALLATION
TOOL SCANIA Ø185mm



For seal inner Ø
155mm

Engines: 8.9I PDE, 9.3I PDE, 9.3I XPI,
12.7I XPI, 15.6I PDE, 16.4I XPI



OM 0346

ENGINE CRANK ROTATOR TOOL
SCANIA



Suitable for SCANIA after 1996 and BL 2003R.

OEM codes:
99309



OM 7051

DPF ASSEMBLY/DISASSEMBLY SCANIA

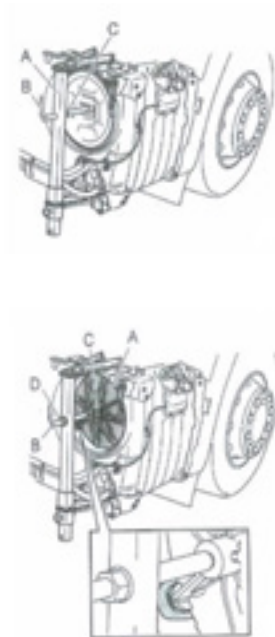

OH 8005

HGV BATTERY CRANE





DAF

OM 0531

CRANKSHAFT FRONT SEAL INSTALLATION TOOL DAF



Dimensions:
 • Øext. 180mm
 • Øinn. 154mm
 • thickness 12mm

Models: DAF 75, 85, 95 CF/XF
 OEM code seals : 0681704 - 682961 - 1457021 - 681704 - 1370127 - 1275083



OM 3970

GEARBOX OIL COOLER SUBSTITUTE DAF 105

Specially designed to remedy gearbox oil cooler failures that immobilize the vehicle, the radiator replacement is mounted instead of the defective radiator. It then allows a normal circulation of oil in the circuit. The vehicle can be driven back to the nearest garage.



OM 3971

GEARBOX OIL COOLER SUBSTITUTE DAF 95

Specially designed to remedy gearbox oil cooler failures that immobilize the vehicle, the radiator replacement is mounted instead of the defective radiator. It then allows a normal circulation of oil in the circuit. The vehicle can be driven back to the nearest garage.





MERCEDES/MAN

OM 0304

FLYWHEEL ROTATOR TOOL FOR ACTROS/ATEGO/MAN ENGINES



Suitable for Actros/Atego
Mercedes 900, 904, 906
Man 5, 6, 8 cylinder engines,
D25/D28



OM 0348

FLYWHEEL ROTATION TOOL MAN



Suitable for MAN engines D20, D25, D26, D28.



OM 0302

FLYWHEEL ROTATOR TOOL FOR MERCEDES/MAN ENGINES



2 gears
Suitable for Actros 6,8,10 cylinder engines
Mercedes 400, 401, 402, 403, 404, 407, 409H/HA,
421, 424, 441, 444A/LA, 427, 4289, 447H/HA
Man 12 cylinder engines



OM 4055

ADJUSTMENT KIT VAG 2.5 PD TDI



Models: Touareg, Transporter
Engines: 2.5 TDI PD

OEM codes:
AXD, AXE, BAC, BLJ, BLK, BNZ, BPC, BPD, BPE





OM 0366
LIEBHERR ENGINE ROTATION TOOL



OM 5038
SEAL TOOL KIT 24PCS

This kit allows the SPI seals to be replaced with diameters of Ø21.5 to Ø64mm.
Removal: compact puller with unique extracting hooks, quick removal without any damaging.
Installation: the interchangeable seal mandrels mean that the seal can be guided back into place for perfect positioning.
2 pairs of claws L.70 and L.115mm for increased polyvalence.



SA 5038 HOOK KIT L.70 and 115mm



OM 5041
17 CRANKSHAFT SEAL INSTALLATION CUPS

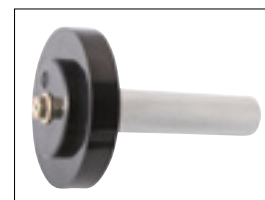

- Contents:**
- 1 crankshaft seal installation tool
 - 3 cups Øint 53.4 - 61.5 - 80mm
 - 14 cups Øext 33 - 37.8 - 41.2 - 42.6 - 48.7 - 52 - 53.4 - 61.2 - 75.6 - 64.4 - 68.8 - 82 - 84.9 - 88.8mm



OM 9216
4 HOOK SET FOR JOINTS

Special hooks for joints L.130mm



BELT

OM 3789

30PCS FREEWHEELING ALTERNATOR PULLEY DISMANTLING KIT

Series of sleeves and locknuts, allowing the disassembly of the disengageable alternator pulley (dismantled or directly on the vehicle).



NEW

Compatible with 1.6 HDI
and TDCI PSA/FORD

Applications: Renault, Peugeot, Citroën, VAG, BMW, Mercedes, Opel, Ford, Fiat, Toyota, Honda, Porsche...



OM 4044

UNIVERSAL BELT PULLEY PULLER QUICK APPROACH Ø47-110mm



For the extraction of camshaft pulleys 2,3,4,6 and 9 arms. Also suitable for crankshaft pulleys/damper pulleys with threads in M8x1.25 and M10x1.5 and some flywheels.

Delivered with:

- claw set 1.5DCI (SA 4046)
- claw set M8x1.25 L. 50mm
- claw set M10x1.5 L. 50mm

2
WARRANTY



INJECTION

AC 4012

600bar PUMP FOR INJECTOR CALIBRATION

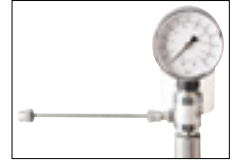

To check the diesel injectors: blocked openings, pressure and shape of jets.

Pump supply lines supplied with connections Ø12-14mm and manometer.

Warranty: never use this pump with diesel or other fluid, use only our special SA3013 fluid shown opposite.



SA 3013	2L CAN OF SPECIALIZED OIL	Spare part of AC 4012
AC 4023	CALIBRATION PUMP ADAPTER M31x100	

AC 4015

DIESEL FUME EXTRACTOR



Calibration pump not included

Improves visual trials of injectors and sucks out any spray.

- Specifications:**
- clip to hold the injector in place
 - compressed air vacuum
 - apparatus to protect the user's health



OE 7201

ULTRASONIC CLEANER 9L 200W 40KHz



- Specifications:**
- heating temperature adjustable from 0 to 80°C
 - timer from 1 to 99 minutes
 - heating power: 300W
 - digital display
 - tank drain valve
 - external dimensions: 300x240x150mm
 - tray dimensions: 330x310x270mm



OE 7200

ULTRASONIC CLEANER 3L 100W 40KHz



SA 7070 TUB OF ULTRASOUND CLEANING SOLUTION 2l

- Specifications:**
- heating temperature adjustable from 0 to 80°C
 - timer from 1 to 99 minutes
 - heating power: 100W
 - digital display
 - tank drain valve
 - tray dimensions: 240x140x100mm
 - external dimensions: 270x240x170mm

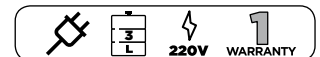

AC 5280**8-CYLINDER COMMON RAIL INJECTOR TESTER**

Covers the majority of vehicles with Bosch Common Rail injectors (excluding Opel), Denso, Delphi and Siemens. This composition allows to detect problems of injector flow rate.

Adapters for Bosch, Delphi and Denso injectors.

NEW

A) The engine runs without starting.
The placement of the graduated pencils allows you to diagnose:
- if all levels are similar:
The injectors are working properly.
- if one level is found to be significantly higher than the others (25%), this injector is damaged
The method is faster:
- direct connection to the injector
- the fuel penetrates directly into the rods.

B) The engine starts.
The use of vials is recommended.
If an excessive flow is found in one of the vials, replace the injector connected to this vial.

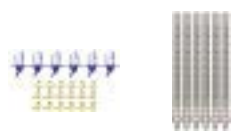

SA 5240	6 CRAYON SET
SA 5242	24 CONNECTOR SET
SA 5281	SET OF 8 VIALS + HOLDER + HOSES



Foaming penetrating formula, dissolves calamine and soot.

Injector extraction
see p. 217

CO 1025**INJECTOR/GLOW PLUG RELEASER 500ml**

Accessory of OP 9210

Allows injectors and glow plugs which have seized up due to calamine and soot to be released.
Can also be used to clean turbos, EGR valves and exhausts.



OM 9261

LCV/HGV INJECTOR-HOLDER REMOVAL WRENCH



Set of 4 pins sockets for the removal of injector holders on some commercial vehicles and HGVs.

- 1/2" D. 4 pin socket L.72mm: Mercedes OM Series 401/421, 403/423, LA, A, 470
- 32mm D. 4 pin socket L.70mm: Mercedes, Neoplan, Setra
- 1/2" D. 3 pin split socket L.120mm: Mercedes, MAN
- 32mm D. 4 pin socket L.120mm: MAN, Mercedes



OM 0070

1/2" D. SOCKET SET FOR INSTALLING/REMOVING INJECTOR HOLDERS



Contents:

- SA0081: 1x22mm hex socket L.110mm with window
- SA0082: 1x22mm double hex socket L.78mm with window
- SA0083: 1x27mm double hex socket L.78mm with window
- SA0084: 1x28mm double hex wrench L.78mm with window



OM 0071

1/2" D. HEX SOCKETS SET FOR REMOVING DIESEL INJECTORS HEADS



Contents:

- SA0011: 1/2" D. split socket 25mm
- SA0078: 1/2" D. split socket 27mm
- SA0012: 1/2" D. split socket 29mm
- SA0014: 1/2" D. split socket 30mm



OM 0080

DIESEL INJECTOR LINE SOCKETS SET 1/2" DOUBLE HEX Ø12-14-16-17-18-19mm



BMW/VAG/MERCEDES



OM 6058

1/2" D. 58T PRE-CHAMBER SOCKET DIESEL ENGINES



Suitable for diesel engines Opel 2.0DI, 2.2 DI with OEM codes X20DTL, X20DTH, X22DTH, Mercedes CDI, 601, 602, 603, 605, 606, 661, 662



OM 4033**SLIDE HAMMER 7.5kg**

Designed to furnish high impact forces, it is used by placing both hands on the sliding weight.

Shaft threaded at both ends 5/18" UNF thread at one end and metric M18x1.5 at the other making it compatible with injector adapters, hub extractors, etc.

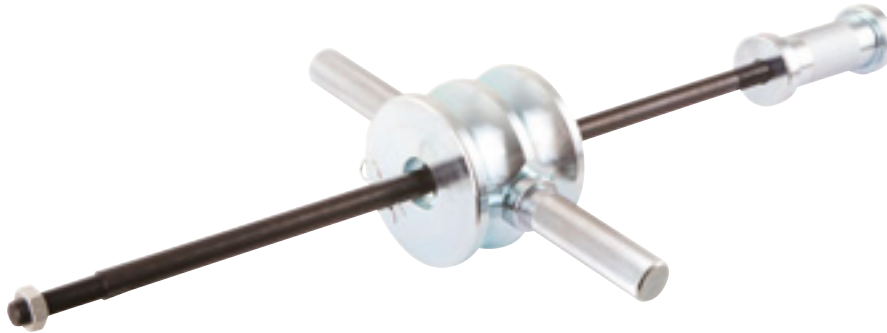
**Specifications:**

- total length 765mm
- shaft length 660mm
- weight of inertial extractor: 7.5kg
- double threaded shaft to suit adapters: 5/18" UNF

**OM 4224****INJECTOR ADAPTER M18x150**

Accessory of OM 4033/OM 4222

This ball joint was designed for inertial weight OM4022 and OM4033 for injectors that have seized up or blocked, facilitating the access to the extractor on vehicles where this is not difficult to access.

Examples: Espace, Scénic, C4 Picasso... with advanced windscreen bay.

**OM 9277****ELECTRODE REMOVAL WRENCH 1/2"**

Spare part of OH 0027/OM 5310



Hex 10mm

Allows you to remove the internal electrode of Bosch common rail injectors

**OM 4202****ADAPTERS FOR BOSCH AND DELPHI INJECTORS**

Accessory of OM 4033

**Contents:**

- bosch Adapter M20xM17x1.0
- delphi adapter M20xM14x1.5
- electrode removal wrench hex Ø10mm
- reducer M20x5/8" UNF



OM 4022

INERTIAL INJECTOR EXTRACTOR BOSCH/DELPHI

Allows fast and effortless extraction of the blocked injectors in the cylinder head.



SA 9026	FORK Ø16mm FOR EXTRACTOR
SA 4026	ADAPTER M18x1.5-M22x1.5
SA 4023	EXTERNAL GRIP ADAPTER BOSCH INJECTORS
SA 4027	INERTIAL INJECTORS ADAPTER BOSCH

Contents:

- slide hammer 3.5kg
- inertial extraction rod M18x1.5 L.280mm
- inertial extraction rod M18x1.5 L.360mm
- SA9026: fork 16mm for extractor
- SA4222: adapter M18-M20x1.5
- SA4026: adapter M18-M22x1.5
- SA4027: inertial adapter Bosch injectors



OM 5084

INJECTOR EXTRACTION LEVER M12x1.00 MALE

Accessory of OM 5081/OM 5085/SA 5080/SA 5083/OM 5083



- allows the injector to be unblocked.
- screws onto the connector to the fuel supply line.
- no injector disassembly required, can be reused if still functional.

For Bosch / Delphi (M12x1.00) / Denso / Siemens injectors



OM 5083

INJECTOR EXTRACTION LEVER M12x1.5 FEMALE

Accessory of OM 5081/OM 5085/SA 5083/SA 5080/OM 5084



- allows the injector to be unblocked.
- screws onto the connector to the fuel supply line.
- no injector disassembly required, can be reused if still functional.

For Bosch / Delphi (M12x1.5) / Denso / Siemens injectors



OM 5085

UNIVERSAL EXTRACTION KIT BOSCH/DELPHI/DENSO/SIEMENS



No disassembly of the injector required, can be reused



Contents:

- SA5080: 1340g slide hammer
- SA5081: Ø15mm inertial extraction rod
- SA5082: inertial injector extraction adapter Bosch 29-30mm
- SA5083: Ø15mm inertial extraction cardan
- OM5083: female injector extraction lever M12x1.5
- OM5084: male injector extraction lever M12x1.00
- OM9242: VW injector extraction adapter

Allows inertial injector extraction in three different ways: with the aid of pliers, a Bosch adapter or an extraction lever. Without uninstalling the body of the injector or the electronic connection section, the injector can be reused if it is still functioning well.

Adaptable inertia hammer on an inertial extraction cardan for increased efficiency on injectors which are difficult to access.



OP 1480**PNEUMATIC CHISEL TOOLS**

Chisel set for an easier removal of corroded, seized or crimped parts.

Specifications:

- capacity: 2200bpm
- operating pressure: 5 to 8bar
- consumption: 114l/min
- noise level 100dB

Contents:

- SA1480: chipping/chisel hammer
- SA1481: adapter for 1/2" D. impact sockets
- SA1482: adapter for Ø38-63-74mm blocks
- SA1483: circular shaped block Ø38mm
- SA1484: rounded hollow block Ø63mm
- SA1485: circular shaped block Ø74mm
- SA1486: circular shaped block Ø25mm
- SA1487: rounded hollow block Ø25mm
- SA1488: 10pcs O-rings

**OH 0025****INJECTOR MECHANICAL-HYDRAULIC EXTRACTOR 12T**

Essential tool for easy extraction of injectors which are stuck into cylinder head. Thanks to its small size, it can be used directly on the vehicle in addition to mechanical extractor: it is therefore unnecessary to take out the engine.

**Specifications:**

- maximum stroke: 8mm
- dimensions: Ø80x55mm
- screw torque: 67mm
- pressure: 700bar
- cylinder port: Ø21.5mm
- recommended fluid viscosity: -15/100mm2

Contents:

- SA0025: long extraction screw M18x1.5-M17x1 for OH0025/OH0027
- SA0019: long extraction screw M18x1.5-M25x1 for OH0025/OH0027
- SA0018: long extraction screw M18x1.5-M27x1 for OH0025/OH0027
- SA0020: long extraction screw M18x1.5-M14x1 for OH0025/OH0027
- SA2700: 12T mechanical-hydraulic ram for OH0025/OH0027

**OM 9366****INJECTOR EXTRACTOR RENAULT/NISSAN/OPEL 2.0-2.2-2.5 DCI****Contents:**

- SA9266: injector extractor Renault
- SA9269: Renault Master adapter
- SA9271: optional Renault support

Models:

Renault: Mégane 2-3, Scénic 2-3, Vel Satis, Laguna 2-3, Espace 3-4, Master 2-3, Trafic 2-3, Koleos
Opel: Movano, Vivaro
Nissan: Interstar, Primastar, Kubistar

Engines: 2.0-2.2-2.5 DCI

Codes: G9T, G9U, M9R

Injectors: Bosch, Bosch Piezo, Siemens, Siemens Piezo



OM 9276

INJECTOR EXTRACTOR PSA 2.0-2.2 HDI



Injectors: Bosch, Siemens

Models:

Peugeot: 307, 307cc, 308, 407, 407 coupé, 607, 806 (16V), 807, Expert

Citroen: C4, C5 II, C5 III, Sinergie, Evasion, Dispatch, Jumpy, C8

Fiat: Ulysse, Scudo

Lancia: Phedra, Zeta

Engines:

PSA: 2.0 HDI (only 16V), 2.2 HDI

Fiat/Lancia: 2.0 JTD, 2.2 JTD

Codes: RTH, RHW, 4HW, RHT, RHM, RHR, RHK



OP 9210

VIBRATION PNEUMATIC PULLER FOR EXTRACTION INJECTORS

Accessory of OH 0027/OH 0025/OM 9250/OM 9366

Allows the take-off of seized injectors in all simplicity and autonomy. Optimum efficiency coupled with a hydraulic or manual extractor, to apply traction on the injector simultaneously with vibrations.

Self-employment

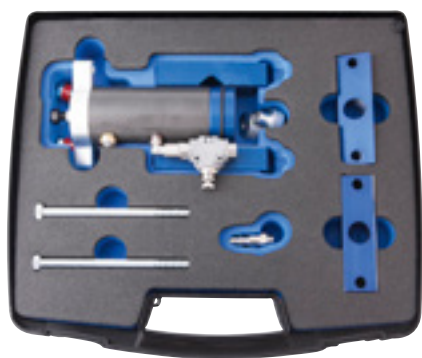

Specifications:

- average duration of use: 15min bursts
- max. pressure: 6.3bar
- no operator required after installation and start-up

Contents:

- pneumatic vibrator with regulator
- pair of inclined jaws
- pair of orthogonal jaws
- clamping screws jaws

Option:

- CO1025: injector/glow plug releaser 500ml



OM 9441

INJECTOR PULLER VOLVO/RENAULT/MAN/DAF



OEM codes:

VOLVO D13-D16

MAN TGA 460-480, TGS

MOTEUR D2676 EURO 5, BE, CE, FR, GR

DAF CF65, CF65II, CF65IV, LF45, LF45IV, LF55, LF55IV



OM 5310**INJECTOR EXTRACTOR KIT MERCEDES/CHRYSLER 2.1-2.2-3.0V6 CDI**

This kit allows the removal of Bosch and Delphi injectors mounted on 2.1, 2.2 and 3.0V6 Mercedes and Chrysler engines.
These tools allow the operator to access difficult to reach areas without dismantling the cylinder head.

Engine removal not required

**Models:**

Mercedes: Vito, Vario, CLK, Sprinter, Viano, Classe M, GL, C, GLK, E, CLS, S, R, G
Chrysler: 300 C

Engines:

Mercedes: 2.1, 2.2, 3.0 V6
Chrysler: 3.0 V6

Contents:

- SA9276: main body with extractor M18x1.5-M17x1 Bosch (2.1-2.2)
- extractor screw M18x1.5-M14x1.5 Delphi (3.0V6)
- 1/2" D. Injector socket double hex 29mm
- OM9277: 1/2" D. Injector socket hex 10mm
- extraction device (2.1-2.2)
- extraction supports (3.0V6)

**OM 0075****INJECTOR EXTRACTION KIT MERCEDES CDI****Models:** Sprinter-Vito-Viano-Vario

Up to 2000

Engine codes: OM0611/OM0612/OM0613/OM0646/OM0647/OM0648

**OM 9442****2 ADJUSTMENT JIGS FOR SCANIA PUMP INJECTORS**

Allows height adjustment (66.9mm) when installing the BOSCH injector type PDE 31/PDE 32 on 12 and 16L motors.

**OM 9432****REMOVAL ELECTRODE SOCKET INJECTORS HPI SCANIA PUMP (BOSCH)****OM 9433****INJECTOR SOCKET MAN Ø28mm DOUBLE HEX**

This socket is machined to disassembly the power supply of injectors mounted on MAN TGA 460-480cv.

Engine: D26 euro 5 SCR



OM 9443

INJECTOR EXTRACTOR MAN



For Common Rail TGL injectors on Euro 3-4-5/TGA/TGM/TGX engines.



OM 9410

INJECTOR LINER APPLICATION TOOL VOLVO/RENAULT 7-9L



OM 9411

INJECTOR LINER APPLICATION TOOL VOLVO/RENAULT FH-FM

Accessory of OM 9412



For 12-13 and 16L engines.



OM 9412

INJECTOR LINER APPLICATION TOOL VOLVO/RENAULT FH-FM

Accessory of OM 9411



For 9-11-12-13 and 16L engines.



OM 9420

INJECTOR LINER APPLICATION TOOL PDE SCANIA



OM 9421

INJECTOR LINER APPLICATION TOOL XPI SCANIA



OM 9422

INJECTOR LINER APPLICATION TOOL HPI SCANIA



OM 9275**INERTIAL INJECTOR GASKET EXTRACTOR****OM 9371****SLIDE HAMMER FOR INJECTOR SEALS**
Ø3.5-15.5mm L.440mm

Specially designed to extract copper-coated seals seized at the bottom of injector wells. As they are made from a single conical unit, it is not possible for any part to fall into the engine.

**Specifications:**

- conical in shape, adapts to any diameter
- minimum Ø interior socket: 3.5mm
- maximum Ø interior socket: 15.5mm
- hammer weight: 1.5kg
- length: 440mm

**OM 9110****COMPLETE INJECTOR SEAT CLEANING KIT**

This kit allows you to clean injector seats and wells. The depth-adjustable reamer support allows you to reshape the gasket seat without damaging it.

**Contents:**

- OM9280: 1 injector gasket extractor
- 1 reamer support
- SA9100: 1 brush drive line
- SA9110: 2 small diameter injector well brushes
- SA9111: 2 large diameter injector well brushes
- 1 brush support
- 6 injector well plugs
- 13 reamers (9 flat, 4 conical)
 - 1 flat reamer L.14mm Ø14mm
 - 1 flat reamer L.15mm Ø19mm
 - 1 flat reamer L.15.5mm Ø15.5mm
 - 5 flat reamers L.17mm Ø17-17.5-19-19.5-20mm
 - 1 flat reamer L.19 Ø21.5mm
 - 1 conical reamer L.15.5mm Ø15.5mm
 - 2 conical reamers L.17mm Ø17-21mm
 - 1 conical reamer L.17.5mm Ø20.5mm
- 1 hexagonal wrench 2.5mm
- 1 T-handle and 170mm extension
- 1 cleaning tool L.250mm Ø15.5mm

**OM 9100BL****INJECTOR SEAT CLEANING KIT**

This kit allows you clean injector seats and wells. The depth-adjustable reamer support lets you reshape the gasket seat without damaging it.

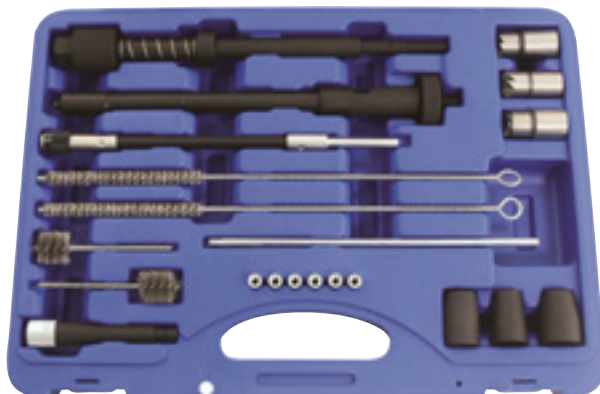
B.LINE**Contents:**

- 1 injector gasket extractor
- 1 reamer support
- 1 brush drive line
- 2 injector well brushes Ø8mm
- 2 injector well brushes Ø20mm
- 1 brush support
- 6 injector well plugs
- 2 flat reamers Ø17mm
- 1 conical reamer Ø17mm



OM 0666

BORE BRUSH SET

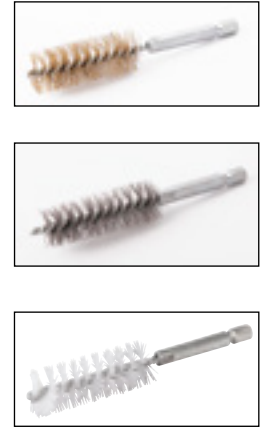

Steel-Nylon-Brass
Ø8 to Ø19mm

SA 0638	10 PCS Ø18mm BRASS BRUSHES SET
SA 0618	10 PCS Ø18mm NYLON BRUSH SET
SA 0619	10 PCS Ø19mm NYLON BRUSH SET
SA 0628	10 PCS Ø18mm METAL BRUSH SET
SA 0629	10 PCS Ø19mm METAL BRUSH SET
SA 0639	10 PCS Ø19mm BRASS BRUSHES SET

This kit allows you clean injector seats and wells.
The depth-adjustable reamer support lets you reshape the gasket seat without damaging it.



CO 1005

PETROL INJECTOR CLEANER 300ml

- High-performance fuel treatment:
- dissolves polluting deposits (calamine, gum, varnish...) for clean combustion for optimal performance
 - lubricates and protects cylinders
 - cleans the injection system

Treats up to 80 liters of fuel



The injection cleanser may be used as a preventive measure (injection circuit protection) as well as a curative measure. If you have never treated your vehicle before and if the first symptoms of injection malfunction are presenting themselves, the injection cleanser will allow you to deep clean the system.

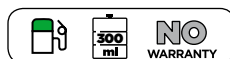

CO 1010

DIESEL INJECTOR CLEANER 300ml

- High-performance fuel treatment for direct injection diesel engines, common rail...:
- dissolves polluting deposits (calamine, gum, varnish, combustion residues...) for clean combustion for optimal performance
 - lubricates and protects mobile parts in diesel engines
 - facilitates cold-starts
 - cleans the injection system

Treats up to 80 liters of fuel



The injection cleanser may be used as a preventive measure (injection circuit protection) as well as a curative measure. If you have never treated your vehicle before and if the first symptoms of injection malfunction are presenting themselves, the injection cleanser will allow you to deep clean the system.

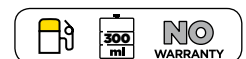

CYLINDER HEAD

AC 3300

CO2 DETECTION KIT



- checks for gas combustion in the radiator
- the test fluid changes colour if a leak is detected
- fast identification of defective head gasket

1- with the engine hot, take off the radiator cap or the expansion-tub cap and pour in the indicated dose of the tracking fluid.

2- Put the bulb on the tube and squeeze it several times. Any gas in the cooling system mixes with the tracking fluid. The blue tracking fluid changes color (turns yellow) if there is an internal combustion fault that forces CO2 into the cooling fluid. Conclusion: problem with the cylinder head gasket.

AC 3350 CO2 DETECTION FLUID

Spare part of AC 3300

2
WARRANTY



OM 5026

MECHANICAL STETHOSCOPE

Very simple diagnostic tool for listening to engines, cylinder heads, gearboxes, bearings... Made with steel and plastic, this tool is oil proof and complements researching sounds which are otherwise difficult to discern.

- extended steel probe: 290mm
- total length: 1100mm

2
WARRANTY

CO 1020

BLACK SEALANT CARTRIDGE -40/+250 DEGREES 200ml



Resistant to hydrocarbons

Allows joints to be sealed (sump, water pump, gearbox) and mechanical parts (fuel pumps, carburetors).

Also suitable for sealing headlights and electrical connections. Even adhesive in oil. Slow skin formation (20 minutes) to work serenely during major operations (gear box turning type).

Specifications:

- elastomer: 400% elasticity
- resistant to high temperatures (250°C)
- drying by touch: 20min
- vacuum package, with trigger

200 ml NO WARRANTY

CO 1014

300 ml ENGINE LEAK STOP



300 ml NO WARRANTY

AC 0800

DIGITAL MASTER KIT PRESSURE GAUGE SET

Universal digital pressure gauge, allows the measurement of vacuum, or pressure, air, all types of fuels and also adblue.

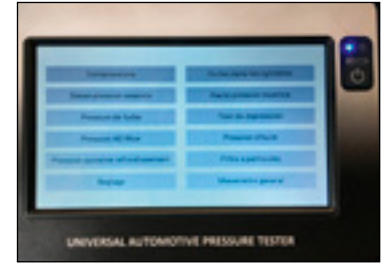

Clear and precise reading of live values
Registration for expertise



The instrument is equipped with a sound and visual safety device to identify the sensor according to the measurement, the calibration is simple and integrated into the instrument.

Contents:

- 1 TFT color display tester 7" with resistive touch screen
 - battery: lithium polymer 3.7V / 2000mA
 - USB smart battery charging with LED indicator
 - PC connection via USB port
 - ABS case with rubber bumpers
 - all screws are mounted on brass inserts
 - 1/4 thread brass insert at the back to fix the bracket
 - 1 sensor 0-300 bar
 - 1 sensor 1-3 bar
 - 1 universal diesel compression adapter
 - 1 universal fuel compression adapter
 - 12 quick connectors, original manufacturer, extremely flexible
- All components are available at retail



HU 4030
MALE CONNECTOR
SCANIA VOLVO ZF



HU 4031
FEMALE CONNECTOR SCANIA
VOLVO ZF

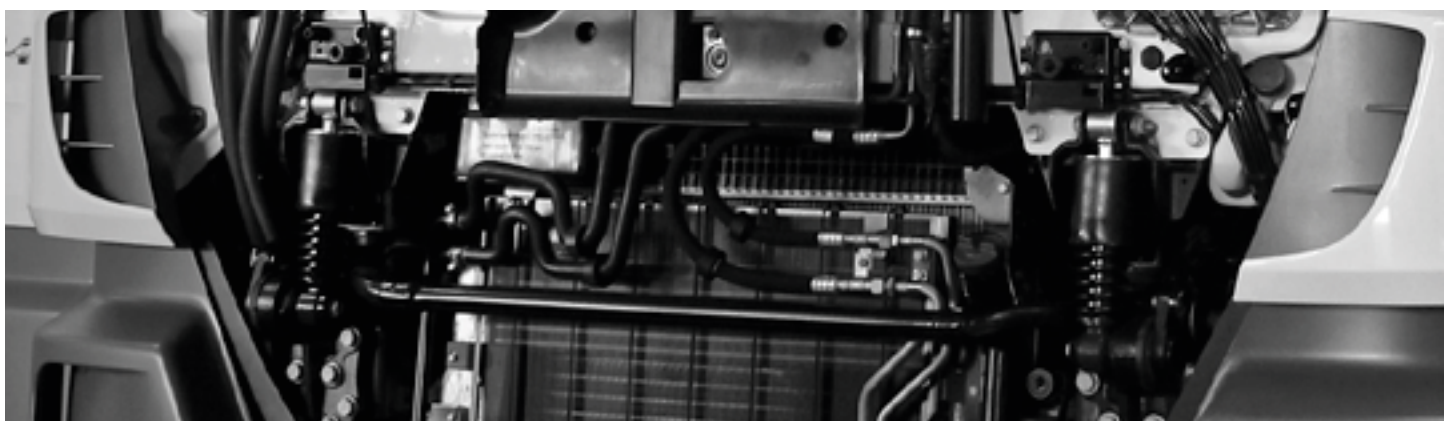

AC 0200**DIESEL COMPRESSION GAUGE**

Connection method using dummy injectors or glow plugs. Compatible with AC2024. Easy to use.

- supplied with AC0210: 50 high-precision, easy-to-read, 10-40bar diagrams- 8 attempt database recording (+2 in reserve)

**AC 0224****COMPRESSION MEASURING KIT FOR DIESEL ENGINES**

Easy and ready to use, this kit covers 90% of vehicles. Applications available on request.

Contents:

- AC2024: diesel glow plug kit
- AC0200: diesel compression gauge

**AC 2024****DIESEL GLOW PLUG KIT**

Accessory of AC 0200/AC 0118/AC 2016

Glow-plug kit (diesel and common rail) that can connect to AC0200 compression gauges and AC0118 seal sensors.

Applications:

Alfa, Audi, BMW, Chrysler, Citroen, Daewoo, Fiat, Ford, Honda, Hyundai, Isuzu, Jeep, Kia, Lada, Lancia, Land Rover, LDV, Mazda, Mercedes, Mitsubishi, Nissan, Opel, Peugeot, Range Rover, Renault, Rover, Saab, Seat, Skoda, Suzuki, Toyota, Vauxhall, VW, Volvo



Covers 90% of vehicle - applications available on request.

**AC 2021****UNIVERSAL DUMMY INJECTOR**

Accessory of AC 0200/AC 2024/AC 0224

Universal dummy injector, can be mounted in place of the original injector for engine compression.

Universal, 5 in 1

**Contents:**

- dummy injector body
- 5 adapters/nose injectors
- 7 injector length adjustment spacers
- 3 fixing flanges
- spare copper gasket pouch

Adapters/Nose:

- Ø16.75mm without nose
- Ø16.75mm nose Ø6.65mm
- Ø20.55mm nose Ø13.65mm
- Ø23.70mm nose Ø13.65mm
- Ø23.75mm nose Ø5.75mm





Prevents assemblies subject to vibrations from unscrewing. Affixes screws/bolts and various threads while allowing easy removal using tools.

CO 1039

STRONG THREAD LOCK 10ml

CO 1038

MEDIUM-STRENGTH THREAD LOCK 10ml



OM 0159

PISTON INSERT GUIDE DAF



Conical interior Ø139 to 129mm.



OM 7450

CYLINDER LINER APPLICATION TOOL 60-160mm

Allows the extraction of HGV cylinder liners. Also suitable for any other extraction requiring an interior grip and having a flat support.



Internal plug Ø60 to 160mm



OM 0503

EXPANDING ENGINE CYLINDER HONE

Allows quick cleaning and de-icing of cylinders by removing carbon deposits. Bevelled stones for an optimal contact surface and more precision. Flexible, diamond knurled shank for a better grip in the chucks.



Specifications:

- adjustable from Ø50 to Ø180mm
- SA5503: 100x11mm stones 3pcs
- grit 240 medium

SA 5503 3 STONE SET



AC 0118

UNIVERSAL CYLINDER LEAK DETECTOR TESTER



This tool allows the seal of the cylinders to be tested without the need to open up the engine. It is one of the simplest and fastest tests to use to check the engine's condition. Air is injected through the plug well into each cylinder, and the dial indicates if there's any pressure loss. Engine compression leaks can damage valves, wear segments, crack the cylinder head gasket or the cylinder head.

The adapters supplied with this leak tester fit with all the plug wells (10, 12, 14, 18mm) and the long adapter (220mm) is very useful for the plugs with deep wells, as mounted on various vehicles.



This piston ring compressor tool is necessary for the installation of pistons into the cylinder block. The compressor folds around the piston, holding the rings in their grooves and allowing the piston and ring assembly to slide into the bore without damaging the pistons or rings.



OM 0153

PISTON RING COMPRESSOR Ø53-125mm H.75mm



OM 0154

PISTON RING COMPRESSOR Ø65-135mm H.100mm



This piston ring compressor tool is necessary for the installation of pistons into the cylinder block. The compressor folds around the piston, holding the rings in their grooves and allowing the piston and ring assembly to slide into the bore without damaging the pistons or rings.



OM 0155

PISTON RING COMPRESSOR Ø90-175mm H.165mm



OM 0104

SPRING LIFTER VALVE SET

This tool is for compressing valve springs acting as a lever to increase strength and reduce effort. The compression cup can be adapted according to the spring's diameter.



Without disassembly of the cylinder head



Contents:

- 1 valve spring lifter
- 3 mounting brackets
- 4 compression cups Ø24, 28, 30, 36mm



OM 0103

VALVE SPRING LIFTER

Can be used generally on a wide variety of engines (OHC, OHV et CVH)
Designed for petrol and diesel engines



- opening capacity 55-175mm, height under groove 165mm
- SA0103: reversible valve spring lifter adapter Ø25 & 30mm



OM 0614

2 VALVE LAPPING TOOL SET

Suction cups: Ø15, Ø19, Ø27, Ø35mm



OM 0109

UNIVERSAL VALVE LIFT HGV/INDUSTRIAL VEHICLES



OM 0106

VALVE STEM SEAL DISMOUNTING PLIERS



AC 0010

STRAIGHT EDGE FOR CHECKING CYLINDER HEAD FLATNESS 600mm

Allows you to simply and precisely check for unevenness in surfaces such as the cylinder head or individual cylinder heads. Allows you to check up to 6 cylinder heads.



- tolerance: < 0.05mm
- material: Carbon steel
- dimensions: L.600xW.36xH.16mm



AC 0011

STRAIGHT EDGE FOR CHECKING CYLINDER HEAD FLATNESS 400mm

Allows you to simply and precisely check for unevenness in surfaces such as the cylinder head or individual cylinder heads. Allows you to check up to 4 or 5 cylinder heads.



Strong ribbing ensures high rigidity
Reinforced edges

Specifications:

- tolerance: < 0.05mm
- material: steel
- dimensions: L.400xW.40xH.8mm
- DIN 875



EG 1560

CAST IRON SURFACE PLATE FOR CHECKING HEAD FLATNESS

Allows simple and precise control of surface flatness flaws such as cylinder heads. Up to 6 cylinder heads can be checked.

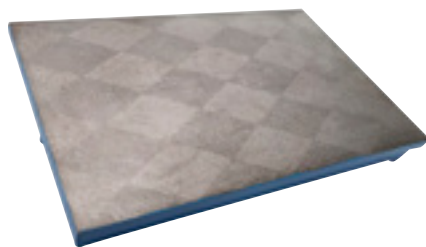

Specifications:

- strong ribbing for high rigidity
- reinforced edges
- tolerance: < 0.05mm
- weight: 80kg
- dimensions: L.800xI.500xH.90mm
- DIN 876



OP 0102

PNEUMATIC VALVE GRINDING TOOL

This device grinds the valves automatically and perfectly evenly, by rotating alternately to the right and the left. All the rotating parts are precisely tooled, ensuring that the device has a long life. Sold in a plastic box complete with suction cups and sockets so that the valves can be picked up by the stem or the head. Shaft speed adjustment carried out by increasing or decreasing the air flow.



- Pneumatic grinding tool supplied with:
- SA6955: 1 rubber suction cup Ø22mm
 - SA6956: 1 rubber suction cup Ø33mm
 - SA6957: 1 rubber suction cup Ø40mm
 - 1 articulated tip door socket
 - supplied in a box



AC 0517

EXTERNAL MICROMETER 0-25mm

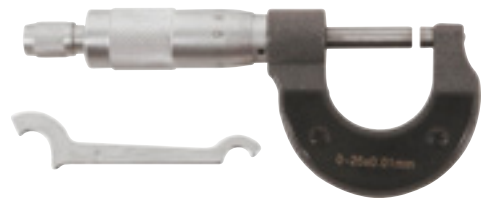

Specifications:

- tempered steel touch
- metal contact surface
- matt chrome-plated body, antireflection
- locking by lever



AC 0528

MICROMETER 25-50mm



AC 0513

CALIPER BASE



Specifications:

- from 0 to 150mm
- resolution 1/20mm
- depth gauge
- locking knob



AC 0511

DIGITAL CALIPER



Specifications:

- from 0 to 150mm
- resolution: 0.01mm
- reset in any position



AC 0520

COMPARATOR+MAGNETIC BASE PACK



Delivered with calibration certificate



Comparator specifications (AC0514):

- measurement range 0 to 10mm
- travel/turn : 1mm
- resolution 0.01mm
- chromed-steel case Ø57mm
- fixing rod Ø8mm
- point zero locking screw

Magnetic base specifications (AC0515):

- joint locking
- magnetic base, attraction strength 80kg
- height: 235mm
- vertical stalk Ø12mm
- weight: 1,850kg



AC 0518

FEELER GAUGE SET



Specifications:

- 20 blades
- 0.05 to 1mm
- resolution: 0.05mm



AC 0530

50-160mm DRILLING INSPECTION DEVICE SET



Allows to check the ovalization flaws of a drill hole from 50 to 160mm

Contents:

- 0.01mm resolution comparator
- cardan drill checker
- 12 pins L.50 to 105mm



OM 0112

MOUNTING GUIDE CYLINDER SET VOLVO/RENAULT 11-12-13-16L



OM 4528

IMPACT SOCKET E28 3/4" L 90mm CYLINDER HEAD FOR MAN/SCANIA





CLUTCH/GEARBOX

CLUTCH

OM 0639

CLUTCH ASSEMBLY/DISASSEMBLY SET



Nowadays, vehicles are more frequently equipped with SAC clutches (Self Adjusting Clutch). These clutches are self-adjustable thanks to their automatic adjustment mechanism which balances the increasing loosening that comes about with wear of the clutch disc. This device ensures regular clutch strength over time and optimal comfort.

Care is required when assembling these clutches because it could deform the clutch mechanism bell cover or displace it if it is done incorrectly. To avoid these problems, the assembly/removal of SAC clutches must be carried out with a special tool.

Applications:	Kia	Saab
Audi	Land Rover	Suzuki
BMW	Mazda	Toyota
Chevrolet	Mercedes	Volvo
Daewoo	Mitsubishi	VW/Skoda/Seat
Fiat	Opel/Vauxhall	Covered the majority of the vehicles equipped of SAC clutches.
Ford	Porsche	
Honda	PSA	
Hyundai	Renault/Nissan	

Supplied with Ø15.8mm new pin for PSA DV10 engines and with new pin for Puma and Opel engines.



OM 0617

CLUTCH ALIGNMENT TOOL



- Length 150mm
- Sockets Ø15-16-17-19-20-21-23-25mm



OM 0618

CLUTCH AXIS EXTRACTOR FIAT/PSA



For Fiat Ducato and Peugeot Boxer from 1994 with pull-type clutch. For extracting clutch stem to remove the transmission.



OM 0621

HGV CLUTCH ALIGNMENT TOOL

For accurate mouting, positioning and centric on single and double disc clutches.



- Contents:**
- 1 expanding guide from 36 to 48mm
 - 1 expanding guide from 42 to 52mm
 - 4 centering valves Ø20-25-27-30mm



HU 1108

MINERAL/MULTIGRADE OIL ELECTRIC
CLUTCH BLEEDER 5-20L 3.5bar



Recommended for HPS-2 gearboxes and
clutches with secondary expansion tank
(Mercedes Actros MP-II, ATEGO, AXOR...).

**Specifications:**

- 220V power supply (5m cord)
- equipped with an on/off switch
- with pressure regulator 0-3.5bar
- pressure gauge for pressure control
- capacity 5 to 20 litres, allowing several operations
- flow rate: 40l/h
- interchangeable canister: ensures compatibility of the mineral/multigrade/pentosin liquid...
- flexible L.3.5m
- automatic triggering
- dimensions: 850x400x330mm
- weight: 22kg

HU 1116	HGV MERCEDES PLUG SET	Accessory of HU 1103/HU 1102/HU 1101/HU 1108
HU 1117	HGV MAN TGA PLUG SET	Accessory of HU 1102/HU 1103

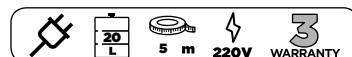

GEARBOX

Specially designed to remedy gearbox oil cooler failures that immobilize the vehicle, the radiator replacement is mounted instead of the defective radiator. It then allows a normal circulation of oil in the circuit. The vehicle can be driven back to the nearest garage.

OM 3970

GEARBOX OIL COOLER
SUBSTITUTE DAF 105

OM 3971

GEARBOX OIL COOLER
SUBSTITUTE DAF 95



2
WARRANTY

HU 8005

GEARBOX REFILLING DEVICE WITH ADAPTERS

Pneumatic and manual pump for fluid refilling. Includes an adapter kit with various outlet angles: made for the poorly accessible areas.



SA8515: oil filling adapter set



Specifications:

- manual flow speed: 0.1l/pump
- pneumatic flow speed: 0.18 at 0.2l/sec
- maximum pressure: 7bar
- drain valve of tank: 1bar
- supplied with a set of 10 connectors
- graduated bowl
- 60 psi manometer
- transport handle
- 1/4 turn valve supply/drain
- offset filling plug

12.5
L **150cm** **2**
WARRANTY

REF	Capacité Capacity	A (mm)	B (mm)	C (mm)	Poids Weight
OH 0236	800kg	850	1870	480	49kg
OH 0237	1500kg	880	1900	700	58kg

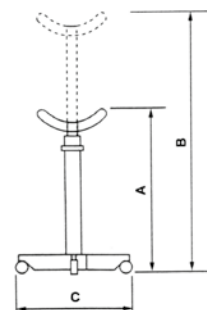

OH 0236

2 STAGE PIT JACK 800kg

Specifications:

- foot control
- chromed rod
- overload safety
- deadman lowering control
- 4 swiveling wheels

Max. Kg
800 **2**
WARRANTY

OH 0237

2 STAGE PIT JACK 1.5T

Max. T
1.5 **2**
WARRANTY



OM 0478

PRIMARY SHAFT SUPPORT FOR ZF ECOSPLIT GEARBOX



ZF 16 S 130
ZF 16 S 160
ZF 16 S 190
ZF 16 S 220
ZF 16 S 221



OM 0475

SPLITTER ADJUSTMENT TOOL FOR ZF ECOSPLIT GEARBOX

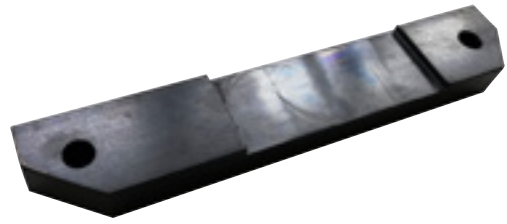

OM 0460

ZF16 GEARBOX BEARING PULLER

Delivered with 5 sets of cups allowing the bearing to grip at the bar turning level, without risk of damage.



OM 0462

NEUTRAL POSITION ADJUSTMENT TOOL FOR ZF AS TRONIC GEARBOX

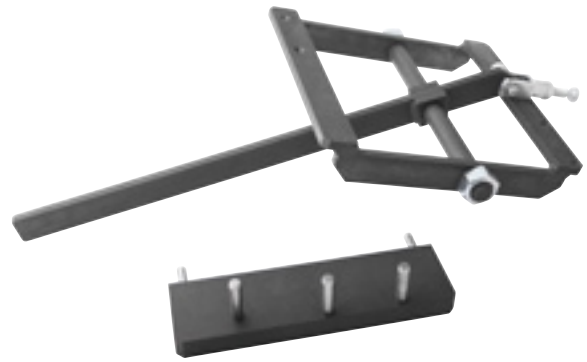

DAF (Euro 3-4-5)

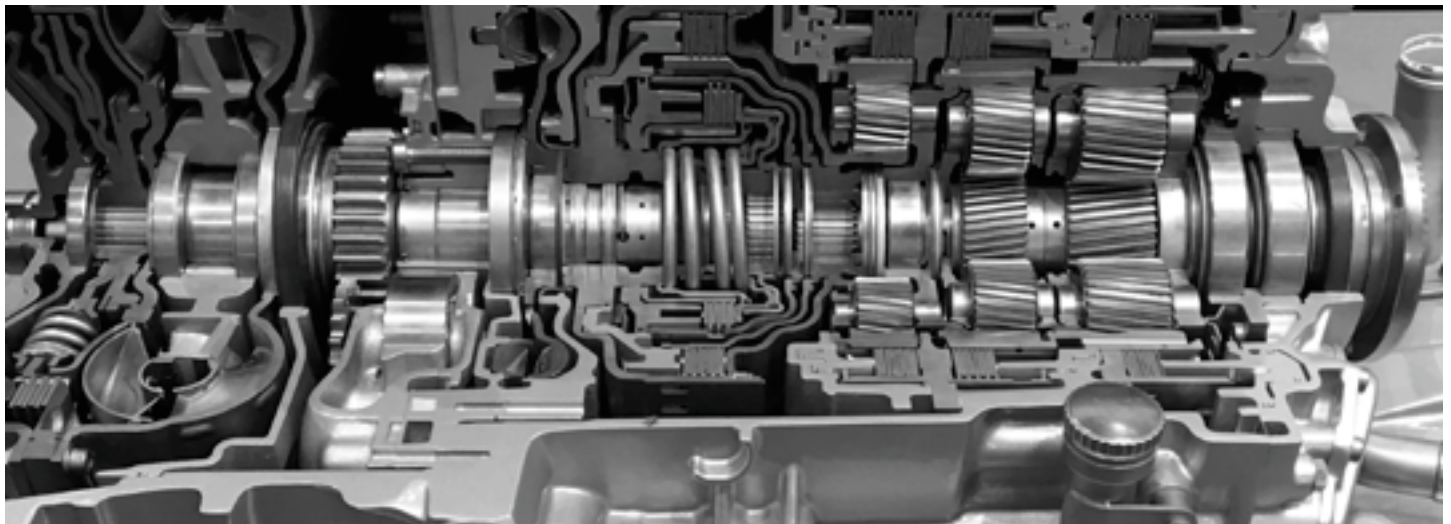

OM 0470

3 BEARING MOUNTING TUBES FOR ZF16 ECOSPLIT GEARBOX



Contents:

- OM0471: Ø93x77mm bearing mounting tube for ZF16 ECOSPLIT gearbox
- OM0472: Ø96x90mm bearing mounting tube for ZF16 ECOSPLIT gearbox
- OM0473: Ø102x96mm bearing mounting tube for ZF16 ECOSPLIT gearbox



OM 0477

PRIMARY SHAFT SUPPORT FOR ZF ECOSPLIT GEARBOX



OM 0476

PRIMARY/SECONDARY SHAFT UNLOCKING TOOL FOR ZF16 ECOSPLIT GEARBOX



OM 0461

BEARING AND GEARWHEEL PULLER FOR ZF16 221-251 GEARBOX



Contents:

- 4 sets of cups
- 1 push screw with support pad
- removing body Ø286mm
- 3 sets of connecting sticks (L. 290-378-500mm)

Cup dimensions:

- 1 set Ø ext. 179mm and Ø inn. 98mm
- 1 set Ø ext. 261mm and Ø inn. 155mm
- 1 set Ø ext. 261mm and Ø inn. 189mm
- 1 set Ø ext. 282mm and Ø inn. 198mm



OM 0465

INSTALLATION/REMOVAL PRIMARY SHAFT ZF AS TRONIC GEARBOX



12 AS 2301 - 16 AS 2601



OM 0467

FORK HOLDING TOOL FOR ZF AS TRONIC GEARBOX



12 AS 2301 - 16 AS 2601



OM 3986

BEARING PULLER FOR GEARBOXES ZF SET



Puller + crankshaft for removing the gearbox bearing infeed for extractor.
For AS TRONIC 10-12-16-speed.

Contents:

- OM3980: bevel gear puller for ZF AS TRONIC gearboxes
- OM3985: crankshaft for removing the ZF gearbox bearing infeed for extractor



OM 3980

BEVEL BEARING GEAR PULLER FOR ZF AS TRONIC GEARBOXES



For ZF Astronic 10-12-16 speed gearboxes.



OM 0469

SET OF 6 SYNCHRO MOUNTING CLIPS. REDUCING GROUP FOR ZF AS TRONIC GEARBOX



AS TRONIC 10 - 12 - 16 speed gearboxes



OM 0468

3 SYNC CENTERING GUIDES FOR ZF AS TRONIC GEARBOX



AS TRONIC 10 - 12 - 16 speed gearboxes



OM 0466

PRIMARY SHAFT POSITIONING TOOL ZF AS TRONIC GEARBOX

Allows the reverse pin to be held when removing the secondary shaft.



12 AS 2301 - 16 AS 2601



OM 3987

11 BALL BEARING EXTRACTOR FOR ZF AS TRONIC GEARBOX



OEM codes:
1X53188009



OM 0562

MOVE/REMOVE HYDRAULIC KIT FOR VT
VOLVO/RENAULT GEARBOX SYNCHRO



Reversible through-cylinder
20T



OM 0561

OIL DISTRIBUTOR REMOVAL WRENCH VT
VOLVO/RENAULT GEARBOX



OM 0560

2 SPACER PLIERS GEARBOX COVER



OM 0563

OUTPUT FLANGE LOCKING TOOL
FOR VOLVO/RENAULT GEARBOX



OM 0515

4-LUG SOCKET 1" FOR INTERNAL NUT SCANIA BOX



OM 0511

4-LUG SOCKET 1/2" FOR DELAYING SCANIA (TYPE 1)



OM 0512

4-LUG SOCKET 1/2" FOR DELAYING SCANIA (TYPE 2)



OM 0556

SET OF TOOLS GASKET INSTALLATION DELAY TIME SCANIA (TYPE 2)



Applications:
Scania Series P, G, R, T



OM 0513

4-LUG THIN SOCKET 3/4" FOR SCANIA GEARBOXES WITH DELAYER



For gearboxes:
GR801-GR900
GRS890-GRS900-GRS920
GRSH900
GRSO900



OM 0514

4-LUG SOCKET 3/4" FOR SCANIA GEARBOXES WITHOUT DELAYER



For gearboxes:
GR801-GR900
GRS890-GRS900-GRS920
GRSH900
GRSO900
Also suitable for transmissions





START & LOAD BATTERY

AC 5245

12V BATTERY TESTER & 12/24V ALTERNATOR

Instruction manual
supplied with the device



1800mm of cable
Suitable for start &
stop batteries

AC 5244

12/24V BATTERY ELECTRICAL SYSTEM TESTER
& 12/24V ALTERNATOR WITH DETACHABLE
PRINTER

Specifications:

- for 12/24V SLI or AGM batteries
- option to select the main national standards of batteries: CCA-SAE-DIN-JIS-IEC-EN-CA
- allows to test: batteries, starters, grounding, alternators (compatible with intelligent alternators)
- test report: results can be printed or transferred to a computer (via supplied USB cable)
- multilingual: FR, ENG, ESP, ITA, GER, NL, ROM, FIN, SWE
- paper 55mm width (SA5245=2 rolls)

SA 5245	2 PAPER ROLL SET	Spare part of AC 5244/SA 5244 Accessory of AC 5245
SA 5244	PRINTER	Spare part of AC 5244 Accessory of AC 5245



MORE

Battery status can be tested by different ways:

- Visual control
- Test with a voltmeter
- Test with a diagnostic device
- Test with a densiometer

BATTERY STATUS	ELECTROLYSE DENSITY	TENSION/VOLT
100%	1.270	12.65
80%	1.250	12.55
60%	1.200	12.35
40%	1.170	12.15
20%	1.130	11.95

OE 3150

DIGITAL VOLTMETER 6-12V



Conversion table of the values (volts) into a charge level (%) integrated in the housing for easy interpretation of the measured values.

Specifications:

- measurement range: 4.5 to 19.99V
- digital display of measured values
- surge protection
- reverse polarity protection
- dimensions: L.120xW.70xH.18mm

**AC 522BL**

12V BATTERY TESTER

**B.LINE**

Battery and load circuit tester with digital display. EASY TO USE: Press the load button and in 10 seconds the test is completed.

Specifications:

- 12V battery of 200-1000 CCA
- also tests the 12V load and starter circuits
- device equipped with a resistor



OH 8005

HGV BATTERY CRANE

Specially designed for dismantling and handling batteries and catalyser on trucks, buses and industrial vehicles. Preserves the physical integrity of the operator.



NEW



Security chain

Adjustable battery holder



Battery strap

Specifications:

- Max. load: 90kg
- 4 wheels including 2 brake swivelling wheels
- lifting height: 1890mm

Max. Kg **90**
WARRANTY **2**

OE 5051

BOOSTER 12V 2500A

Compatible with all 12V vehicles
 Oversized and insulated copper/brass clamps
 Anti-shock ABS case



NEW

Specifications:

- starting current: 850A
- peak current: 2500A
- capacity: 22Ah
- cables: 25mm²
- integrated cigar lighter socket
- charging time: 4-8H
- battery: AGM
- weight: 10,6kg
- dimensions: 320x130x300mm



OE 5052

BOOSTER 12-24V 6200A/3100A

Compatible with all 12V vehicles
 Oversized and insulated copper/brass clamps
 Anti-shock ABS case



Wheels + Handle

NEW

Specifications:

- starting current: 2400A-1200A
- peak current: 6200A-3100A
- capacity: 2x33Ah
- cables: 50mm², L.165cm
- integrated cigar lighter socket
- charging time: 4-8H
- voltmeter digital charge indicator
- battery: AGM
- weight: 29kg
- dimensions: 410x280x550mm

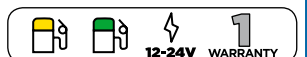

IGNITION/PREHEATING

OP 1404

VIBRATION GLOW PLUG REMOVAL KIT 1/4"

Allows the glow plugs to be removed in a progressive, controlled and secure manner.
Reduces the risk that the electrode may break within the glow plug's housing.



Drive: 1/4"

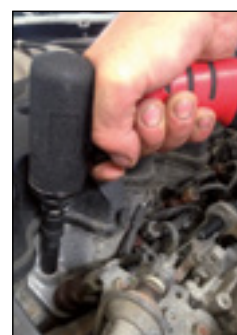
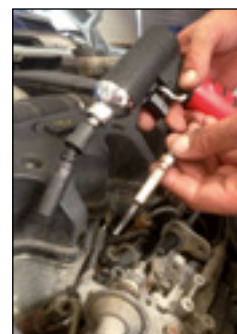

Contents:

- SA1404: vibration socket 1/4"
- SA1408: vibration socket 8mm
- SA1409: vibration socket 9mm
- SA1410: vibration socket 10mm
- SA1411: vibration socket 11mm
- SA1412: vibration socket 12mm
- SA1413: vibration extension 50mm
- SA1414: vibration extension 100mm
- SA1415: 1/4" universal joint for vibration socket

4 pre-set torque setting :
10-20-30 or 40Nm



OM 9213

3/8" PLUG WRENCH KIT Ø8-9-10-12-14-16mm

Friction CV joint that lets it stay in the ideal position
Plug retention gasket.

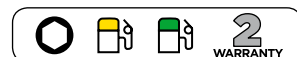

OM 3788**DIESEL UNIVERSAL GLOW PLUG EXTRACTOR**

Minimum space required for use: Ideal when the glow plug compartment is difficult to access.

Can be used in narrow engine compartments and with glow plugs on the firewall side.

Supplied with 3 hexagonal drive taps with easy centering, for thread repair.

**Contents:**

- SA 3801: electrode extractor
- SA 3802: reinforced electrode drill bit
- SA 5328: 2 electrode drilling guides
- SA 3803: 6.8mm stepped drill bit
- SA 3804: 8.8mm stepped drill bit
- SA 3805: drill bit holder
- SA 3809: extraction tap
- SA 3810: inertia extractor
- SA 3811: M8 hexagonal drive repair tap
- SA 3812: M10x100 hexagonal drive repair tap
- SA 3813: repair tap M10x125 hexagonal drive

**OM 3787****GLOW PLUG REPAIR KIT M8x100 M10x100 M10x125 M12x125****Contents:**

- 6 repair taps (M8x100-M10x100-M10x125-M12x100-12x125-M14x125)
- 2 insertion tools
- 3 plug well plugs
- SA3785: 5 inserts M8x100
- SA3786: 5 inserts M10x100
- SA3787: 5 inserts M10x125
- SA3788: 5 inserts M12x125





AIRCON

CONTROL/MEASUREMENT



1 syringe = 1 test



AC 4052

AIR CONDITION R134 CONTROL SET BY TRACER

Contents:

- SA1002: UV Glasses
- OE0396: mini rechargeable inspection lamp 3W COB+ISMD
- CO4077: 12 syringe tracer pack 7,5ml for R134 gas

AC 4053

AIR CONDITION R1234 YF CONTROL SET BY TRACER

Contents:

- SA1002: UV Glasses
- OE0396: mini rechargeable inspection lamp 3W COB+ISMD
- CO4078: 12 syringe tracer pack 7,5ml for R1234 gas



SA 1002	UV GLASSES
CO 4077	12 SYRINGE TRACER PACK 7,5ml FOR R134 GAS
CO 4078	12 SYRINGE TRACER PACK 7,5ml FOR R1234 GAS
CO 4079	12 SYRINGE TRACER PACK 7,5ml FOR HYBRID VEHICLE



OE 0396

UV MINI RECHARGEABLE INSPECTION LAMP



Specifications:

- aluminum body
- 2 magnets + belt clip
- double illumination: to the front + at the top
- LED UV
- UV wavelength: 390-400nm
- overheating and overloading protection
- autonomous operation: 3.5H
- charging time: 3-4H
- charge indicator
- battery: 3.6V 2200mAh
- 220V mains charger
- dimensions: L.111xW.27xH.24mm





- integrated measuring scale
- graduation dosing unit: 5ml
- graduation bottle: 25ml

CO 4068**UNIVERSAL AIR CONDITION TRACER BOTTLE 250ml**

Compatible with all gases: R12, R134, R1234YF

CO 4069**HYBRID VEHICLES AIR CONDITION TRACER BOTTLE 250ml**

Specially developed for air conditioning systems with electric compressors (hybrid vehicles...)

**AC 5028****ELECTRONIC STETHOSCOPE LEAK DETECTOR**

The electronic stethoscope allows you, simply by touching with the tip during static testing, to transmit the sound made by the target through headphones to locate engine pinging, bearing noise, slapping, etc. It also lets you detect air leaks normally imperceptible by the human ear by making the ultrasounds made by an airflow audible.

Specifications:

- can be operated with 2x9V batteries (6F22 type) or equivalent
- response frequency: 36000Hz to 44000Hz
- operating temperature: 0°C to 40°C
- storage temperature: -10°C to 50°C
- weight: amplifier 183g/transmitter 156g

Contents:

- amplifier 176x84x35mm
- ultrasonic transmitter 170x84x36mm
- headphones
- alu stethoscope probe 250mm
- plastic amplifier tube 270mm
- carrying case with foam

**CO 4065****AIR CONDITIONING LEAK STOP 30g****Economical solution**

Allows plugging micro-leaks in metal parts, hoses and joints. Saves time on hard-to-access leaks.

Vacuum canister, no gas is injected: no risk of overpressure or damage to the circuit (unlike syringes and aerosols)

Usable R12, R134. Recommended for vehicles containing up to 350ml of lubricant.

**SA 8989****PAIR OF ULTRANITRIL GLOVES FOR AIR CONDITIONING MAINTENANCE IN388 EN374**

Accessory of AC 1014/AC 1015/AC 1016

**CO 4081****UNIVERSAL AIR CONDITIONING LUBRICANT BOTTLE 1L PAG**

For mechanical and electric Sanden compressors (hybrid vehicles).

PAG lubricant. All gas compatible.

**SA 6500****NEUTRAL PH AEROSOL LEAK DETECTOR**

AC 1017

**NITROGEN/HYDROGEN LEAK KIT (N2-H2)
50bars**

The tooling contained in the case is used to "pressurize" the refrigeration and air conditioning systems in order to "simulate", inside the systems, at which pressure it will have to operate.

Compatible with R134
and 1234YF gas



The R1234YF gas is dedicated to the new cars (class M1 and N1). The new European directive 2006/40/CE stipulates that all used refrigerants must have a GWP (Global Warming Potential) of less than 150.

By pressurizing the installation with technical hydrogenated nitrogen (at an appropriate pressure and therefore different depending on the refrigerants as indicated by the visible sectors on the manometer), the installer will have the certainty, in the event of leakage due to improperly made clampings, "cold" welds or manufacturing faults, that these faults will be indicated by a loss of nitrogen detected by the manometer provided for this purpose. The controlled installation will no longer encounter this type of problem.

Contents:

- carrying case
- SA4062: pressure relief valve block with safety valve up to 50bar
- SA4060: insulation pressure gauge + flexible 100cm
- SA4063: reducer for 1kg bottle
- SA1090: hydrogenated nitrogen bottle (N2-H2)1kg
- SA4061: 160cm piping system
- SA4029: high pressure connection
- SA4052: gas-specific high pressure fitting R1234YF



SA 1092 2.2kg NITRO-TRACE CYLINDER (N2-H2)



AC 7495

UNIVERSAL ELECTRONIC LEAK DETECTOR R134/1234YF/HYDROGEN



Multi-gas

This leak detector with a sensor designed to detect the smallest concentrations of hydrogen nitrogen and other gases.

Compatible with Hydrogen Nitrogen (N2-H2), R134-a, R1234YF, R404-A, R410-A, R407-C, R22, Freon...

When a concentration is detected, an audible alarm is emitted and the display indicates the size of the leak (from 1 to 7).

Specifications:

- sensitivity adjustable on 3 levels
- automatic calibration
- sensor type: Semiconductor
- integrated fan
- power supply: 4 x AA alkaline batteries
- battery life: 4-6H continuously
- low battery indicator
- preheating time 45 s
- probe length: 40cm
- delivered in a suitcase with batteries



AC 1019**DETECTION KIT / AIR CONDITIONING
IMPURITIES FILTRATION SYSTEM R1234YF**

This kit allows you to visually check the condition of the air conditioning circuit.

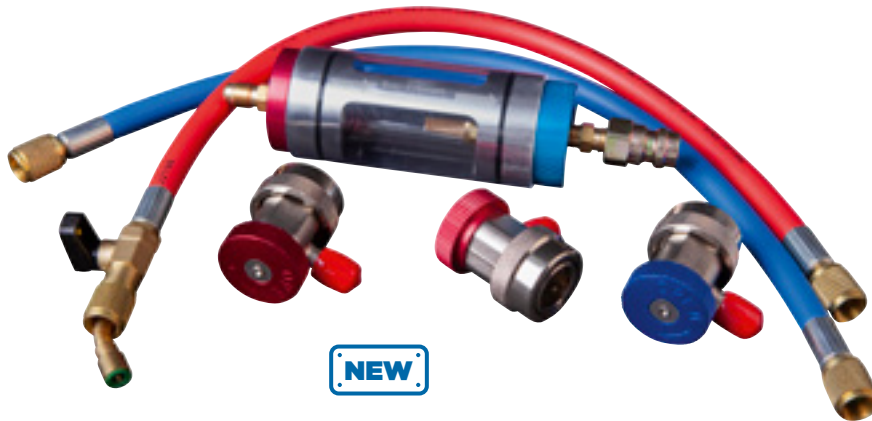
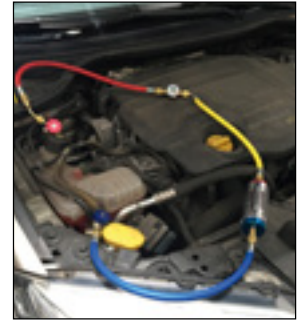
**AC 1018****DETECTION KIT / AIR CONDITIONING
IMPURITIES FILTRATION SYSTEM R134**

Controls the quality of the gas according to its clarity, allows to detect the presence of tracer, stop leak, impurities related to the failure of the circuit, or even the compressor. Our kit is also equipped with a moisture analyzer by changing the color as the gas passes through.

2
WARRANTY

CO 1019**AIR-CONDITIONING CIRCUIT CLEANER 400ml**

Cleans air-conditioning circuits and eliminates bacteria/germs. Enough to clean the system approx. 3 times.



The product is suitable for treating the air conditioning ducts by removing the bacteria, mould and impurities which are found there. It is easy to use and is sprayed out using the air vents. You will once again be able to operate your air conditioning system after 15 minutes.

400
ml
NO
WARRANTY

CO 4074**AIR CONDITION TRACER SPRAY CLEANER
400ml**

Accessory of CO 4077/CO 4078/CO 4079/AC 4052/AC 4053



NEW

Allows to remove the traces left by the tracer in the engine enclosure. Facilitates the detection of a new leak.

400
ml
NO
WARRANTY

CO 1053**AIRCON PERCEPTIBLE CLEANER 150ml**

NEW

Neutralizes odours,
antibacterial

Specially designed to sanitize the cabin by disinfecting and deodorizing aircon systems. Easy to use thanks to the diffuser.

150
ml
NO
WARRANTY

AC 1023

AIR CONDITIONING WASHING KIT



NEW

CO 1070 LIQUID CANISTER WASHING AIR CONDITIONING 5L



An economical way to remove contaminants and scale from air conditioning system components.

Specifications:

- the process thoroughly cleans the circuit by removing oil, contaminants, refrigerant residues and moisture from the circuit.
- essential intervention, when replacing a component of the circuit or simply opening the circuit, to quickly and efficiently remove refrigerant oil and debris when replacing a component (e.g. compressor).
- easy to use: simply fill the decontamination solution cartridge, pressurize with the nitrogen cartridge and purge each component.
The cleaning solution is a highly evaporating product, so there is no risk of leaving moisture in the circuit.
- the drying of the circuit is done naturally with the hydrogenated nitrogen gas used.

2
WARRANTY

OE 5036

INFRARED THERMOMETER -38°/520°



Reliable measurement thanks to high-precision laser aimer. Very practical, the infrared thermometer measures surface temperature requiring no contact, remotely and totally safely.

Specifications:

- temperature range: -38°C/520°C (-36.4°F/968°F)
- accuracy: ± 2°C
- response time: 1s
- resolution: 0.1°C, 0.1°F
- illuminance automatic stop after 15s
- automatic switch off after 60s if no action taken
- power source: 1.5V battery (x2)

1
WARRANTY

AC 4224

DIGITAL ELECTRONIC THERMOMETER



Specifications:

- digital display
- temperature range : -50° to 300°C
- stainless steel sensor
- pressure ±1°C
- battery power 1/5V AAA
- cable length: 900mm
- probe length (chromed part): 170mm
- cable + probe (with handle): 1200mm

1
WARRANTY

AC 4223

DIGITAL THERMOMETER



Specifications:

- digital display
- temperature range: - 40° to 250°C
- stainless steel sensor
- automatic stop
- power supply: LR44 battery (included)
- accurate to :
±2% (between -40°C and 200°C)
±3% (between 200°C and 250°C)

1
WARRANTY

AC 4228

4 COUPLING PUSH BUTTON SET

Dimensions 3/8", 1/2", 5/8", 3/4"



NO
WARRANTY

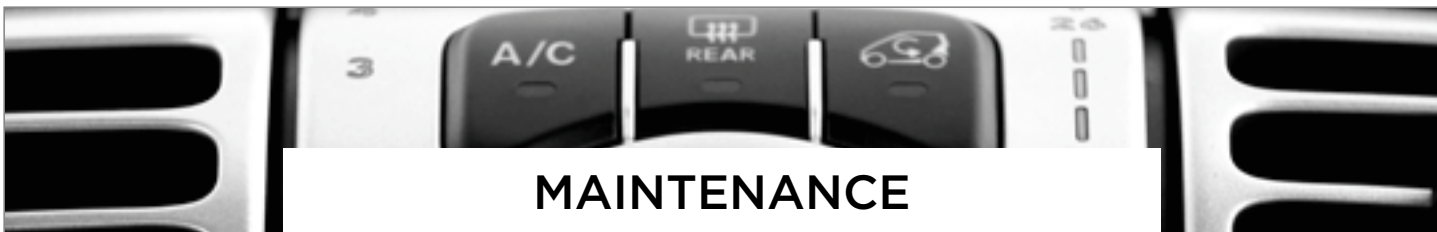

MAINTENANCE

AC 4034

VALVE/CONNECTOR/PLUG AIRCON MAINTENANCE SET

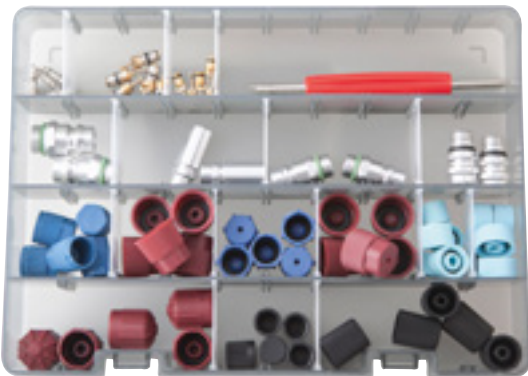

Set of connectors, plugs and valves for all basic maintenance of R134 air conditioning systems.



Components available at retail



AC 4054

AIR CONDITIONING MAINTENANCE KIT R1234YF



Contents:

- CO 4082: 5 valve core 19.0X5.12mm R1234YF
- CO 4083: 5 valve core 21.8X7.8mm R1234YF
- CO 4084: 5 valve core 22.1X9.8mm R1234YF
- CO 4085: 5 valve core 21.5.0X7.8mm R1234YF
- CO 4086: 5 valve core 20.0X7mm R1234YF
- CO 4087: 5 plugs M8X1,0 short R1234YF
- CO 4088: 5 plugs M8X1,0 long R1234YF
- CO 4089: 5 plugs M9X1,0 long R1234YF



AC 4008

SPECIAL A/C JOINT SET



Contents:

- 20 seals 7/32" x 1/46"
- 20 seals 1/4" x 1/16"
- 20 seals 6.8 x 1.9
- 20 seals 5/16" x 1/16"
- 20 seals 7.8 x 1.9
- 20 seals 8 x 2
- 20 seals 8.8 x 1.9
- 15 seals 7/16" x 1/16"
- 15 seals 7/16" x 3/32"
- 15 seals 11 x 2
- 15 seals 12 x 2
- 10 seals 13.9 x 1.8
- 10 seals 9/16" x 3/32"
- 10 seals 14 x 2
- 10 seals 15 x 2
- 10 seals 17 x 2
- 10 seals 11/16" x 1/16"
- 10 seals 11/16" x 1/8"



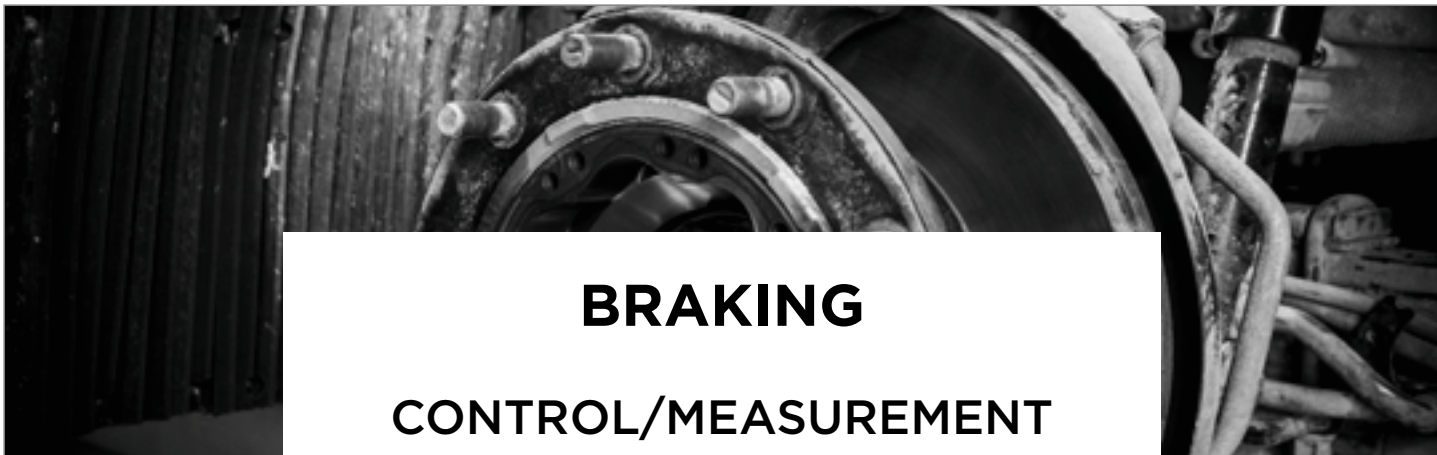

BRAKING

CONTROL/MEASUREMENT

AC 5014

BRAKE & ABS PRESSURE GAUGE SET



This set of brake pressure gauges includes 2 manometers, which connect directly in place of the bleed screws or connections specified by the manufacturer, and allow diagnostics on the brake system (including ABS system).

2
WARRANTY

AC 0520

COMPARATOR+MAGNETIC BASE PACK



Delivered with
calibration certificate

Comparator specifications (AC0514):

- measurement range 0 to 10mm
- travel/turn : 1mm
- resolution 0,01mm
- chromed-steel case Ø57mm
- fixing rod Ø8mm
- point zero locking screw

Magnetic base specifications (AC0515):

- joint locking
- magnetic base, attraction strength 80kg
- height: 235mm
- vertical stalk Ø12mm
- weight: 1,850kg



U
2
WARRANTY

AC 0519

CALIPER BASE Ø DISKS AND BRAKE DRUMS



Specifications:

- working range: 160mm-400mm
- fits a larger range than most similar products on the market
- high-grade steel
- imperial and metric measurement scale

2
WARRANTY

AC 5004

BRAKE FLUID TESTER PROBE



Allows to control the quality of the brake fluid by checking the quantity of water in the fluid. Clear, simple and quick reading of the test result (green/orange/red LED system).

Dot 3-4-5

1
WARRANTY

OM 0358

HGV BRAKE PLIERS L.670mm OPENING
200mm

**OM 0357**

BRAKE PLIERS HGV L.520mm OPENING
210mm

**OM 0320**

BRAKE DISMOUNTING TOOL L.450mm-620mm

**OM 0359**

DRUM BRAKE PLIER IVECO/VOLVO
WITH Z-CAM

Ideal for opening and fixing the brake shoe retaining
spring.

Suitable for Iveco, Volvo Z-cam : N7, N10, N12, F7, F12, F16, FH12,
FH16, FL7, FL10, ERF E series, EC series

**OM 0390**

HALDEX BRAKE LINKAGE ADJUSTER
EXTRACTOR

**OM 0391**

BPW BRAKE LINKAGE ADJUSTER
EXTRACTOR



GSK/AGS



OM 0669

16 PCS IMPACT SCREWDRIVER SET



- Bits:**
- flat 5-6-8-10-12mm
 - hex 4-5-6-8mm
 - philips 1-2-3-4
 - torx 40 (SA0656)
 - + adapter



OM 8023

BRAKE SPRING TOOL

Keeps the handbrake cable spring compressed to make the cable easy to attach to the brake lining.



OM 8022

SPRING COMPRESSION TOOL

Easily compresses spring cups when replacing rear brake linings. The striated cone ensures that the cup is held securely for locking.



OM 8052

BRAKE LINING PLIERS



L.330mm



OM 8053

HANDBRAKE CABLE PLIER



OM 9273

3 PENTAGONAL WRENCH SET



- 1 wrench Ø19mm for Bendix braking system on PSA, Renault
- 1 wrench Ø14mm for Bendix braking system on Smart, Opel, Ford, Mazda
- 1 hex wrench Ø10mm Girling



OM 0503

EXPANDING ENGINE CYLINDER HONE

Allows quick cleaning and de-icing of cylinders by removing carbon deposits. Bevelled stones for an optimal contact surface and more precision. Flexible, diamond knurled shank for a better grip in the chucks.

- Specifications:**
- adjustable from Ø50 to Ø180mm
 - SA5503: 100x11mm stones 3pcs
 - grit 240 medium



OP 4505**23 PCS PNEUMATIC BRAKE CALIPER REWIND SET**

This tool allows the operator to push back the brake caliper pistons very simply and effortlessly thanks to the gun's hydraulic jack which pushes up to 150kg.
The operating pressure is from 5 to 8bar.



This kit includes a pneumatic gun, the traditional adaptors and all the latest adaptors for:

- VW Passat (from 2005)
- Ford
- Iveco Daily
- BMW
- Mini/BMW
- Renault Laguna III/Scénic III
- Renault Master III

For left or right handed threaded pistons.
Supplied in a box.

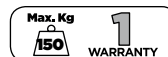
**OM 8168****37 PCS BRAKE PISTON PUSHER SET****Applications:**

- Alfa: 155, 164, GTV
- Audi: 80, 90, 100, 200, A3, A4, A6, A8, S8
- BMW: most models, including Mini
- Citroën: most models
- Fiat: Uno, Stilo, Tipo
- Ford (EU): Escort, Mondeo V6, Sierra, Granada
- Ford (US): Mercury, Monarch, Thunderbird
- Ford (Asia): Telstar, Laser
- Honda: most models
- Jaguar: Most models
- Lancia: Dedra, Delta, Thema, Kappa
- Mazda: RX-7, 323, 626, 929
- Mitsubishi: most models
- Nissan: Most models
- Opel: Astra C, Astra G, Corsa C, Zafira (with Lucas TRW rear calipers)
- Peugeot 206, 306, 405, 406, 409, 806
- Renault: most models including Master
- Rover: Most models
- Saab: 99L, 900, 9000
- Seat: Ibiza 16V, Toledo 16V
- Subaru
- Toyota: most models
- Volkswagen: most models
- Volvo: most models

Right-turn, left-turn
Pin punch

**OM 8158****PISTON PUSHER FOR PAIRED BRAKES WITH INTERCHANGEABLE PLATES**

3 in 1

Ideal for floating calipers.
Adapts to a wide range of calipers thanks to its interchangeable plates.
System to maintain the plate position using fixing screws.

Specifications:

- width of the plates: 88-125-150mm
- height of the plates: 57-77-87mm
- max. spacing: 185mm
- triple drive: manual, 21mm, 1/2"



BLEEDING

HU 1109

PNEUMATIC BRAKE AND CLUTCH BLEEDER

For bleeding brakes and hydraulic clutches of all vehicles, can also bleed vehicles equipped with load-sensitive brake control and ABS (max. 1bar).



Specifications:

- pneumatic operation
- comes with antifoaming rubber membrane
- air reserve in the bottom part of the tank
- 5-litre capacity allows it to be used repeatedly
- fast-connector hose
- balanced carrying handle
- pressure control gauge
- plug storage rack
- compatible with DOT3/ DOT4/DOT5/DOT6 /Pentosin/LHM/LHS

Supplied with:

- 1 metal plug
- 2 brake oil recovery jerrycans



HU 0700

12 BRAKE BLEEDER PLUG SET

Accessory of HU 1109/HU 1107/HU 1110/HU 1005/HU 1105

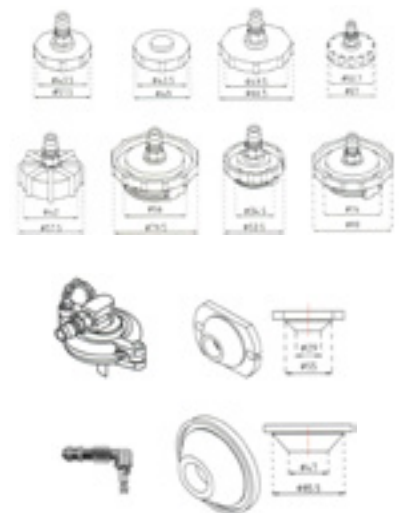

Alfa Romeo, Citroën, Ford, Opel, Peugeot, Seat, Skoda, Volkswagen, Cadillac, Chevrolet, Chrysler, Daewoo, Daihatsu, Dodge, Honda, Hyundai, Isuzu, Jaguar, Jeep, Kia, Lancia, Land Rover, Lexus, Mazda, Smart, Subaru, Suzuki, Toyota, Aston Martin, Bugatti, Maserati.

Contents:

- 2 conical plugs ranging from 30mm to 80mm
- 10 specific plugs



HU 1102**ELECTRIC BRAKE BLEEDER 5-20L 3.5bar**

Automatic stop when the level in the can is too low.
Automatic bleeding after canister change.
Checks low pressure brake system for leaks.
Suction function for expansion vessel, with graduated used liquid recovery canister (1.5L)



Maintaining liquid thrust in pulsating flow

**Specifications:**

- 230V power supply (5m cord)
- equipped with an on/off switch
- equipped with a pressure regulator 0-3.5bar with maintenance of the thrust of the liquid in pulsating flow
- pressure gauge for pressure control
- suitable for clutches and brakes (compatible with ABS, EDS, ESP, SBC systems)
- capacity 5 to 20 litres, allowing several operations
- interchangeable canister: ensures compatibility of the DOT3/DOT4/DOT5/DOT6 liquid
- flexible L.3.5m
- dimensions: 850x400x330mm
- weight: 23kg

Supplied with metal plug Ø43mm

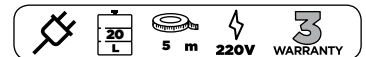

SA 8113 2 BRAKE OIL RECOVERY JERRYCANS

Spare part of HU 1003/HU 1004/HU 1005/HU 1105/HU 1025

HU 1103**ELECTRICAL BRAKE BLEEDER 30-60L 3.5bar**

Automatic stop when the level in the can is too low.
Automatic bleeding after canister change.
Suction function for expansion vessel, with graduated used liquid recovery canister (1.5L)



Maintaining liquid thrust under continuous pressure, pulsating flow

**Specifications:**

- 220V power supply (5m cord)
- equipped with an on/off switch
- equipped with a pressure regulator 0-3.5bar with continuous liquid thrust maintenance
- pressure gauge for pressure control
- suitable for clutches and brakes (compatible with ABS, EDS, ESP, SBC systems)
- capacity 30 to 60 litres, allowing several operations
- flow rate: 60l/h
- interchangeable barrel: ensures compatibility of DOT3/DOT4/DOT5/DOT6 liquid
- flexible L.3.5m
- dimensions: 920x450x560mm
- weight: 33kg

Recommended for Mercedes Actros/Atego equipped with HPS-1

Supplied with metal plug Ø43mm



HU 1113

5 PLUG SET FOR BRAKE/CLUTCH BLEEDERS

Accessory of HU 1101/HU 1102/HU 1103/HU 1104/HU 1108



Applications:

Peugeot : 3008
 VW : Tiguan
 Nissan : Micra
 Toyota : H-CR, Rav4
 Opel : Astra K, Insignia
 Ford : Fiesta, B-Max

Contents:

- universal plug Ø20 to 79mm
- expandable plug Ø41-47mm
- plug 1/4 turn Ø58mm
- plug Ø43mm with 90° connection L.110mm
- plug 1/4 turn expandable Ø35-38mm with 90° connection L.100mm



OP 0053BL

PNEUMATIC VACUUM BRAKE BLEEDER

Allows you empty the brake fluid reservoir and bleed the brake lines.

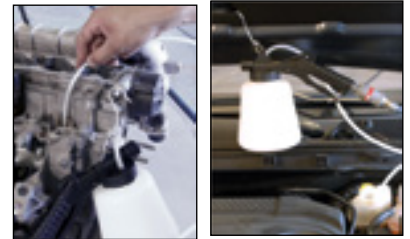

Used to vacuum out impurities:
 injector wells, plug wells, etc.

Bleed screw adapter



OP 0501

PNEUMATIC VACUUM BRAKE BLEEDER

Accessory of AC 4095



Single operator

Allows you empty the brake fluid reservoir and bleed the brake lines.

Vacuum kit capacity 800ml
 Powered by compressed air



HU 0550

METAL PRESSURE AND VACUUM PUMP (-1/+ 4bar)

To test: advance vacuum curve pressure regulator for fuel, LPG, EGR valve (exhaust fumes) TURBO...



- turbo oversupply pressure testing
- fuel pressure regulator watertightness testing
- advance vacuum curve testing
- pressure relief valve testing
- watertightness testing for fuel injection pump LDA membrane
- EGR valve testing
- brake servo-unit membrane

Supplied in a box

SA8071: 360° rotating pressure gauge
 SA8081: set of 8 bits



REPAIR/REBUILDING

OM 8043

HYDRAULIC BRAKE PIPE FLARING TOOL SET DIN/SAE Ø4.75-5-6-8mm

This device makes it possible to remake the brake pipe collars. It will produce SAE or DIN impressions, single or double on 4.75mm, 5mm, 6mm or 8mm pipes.



Does not require
hose removal



Contents:

- hydraulic gun flaring brake hoses
- frame press flaring brake hoses
- handle M8x1.25 L.119mm
- SAE/DIN die brake hoses Ø4.75mm
- SAE/DIN die brake hoses Ø5mm
- SAE/DIN die brake hoses Ø6mm
- SAE/DIN die brake hoses Ø8mm
- punch OP1 for pipes Ø4.75-5mm
- punch OP1 for pipes Ø6mm
- punch OP1 for pipes Ø8mm
- DIN punch for pipes Ø4.75-5mm
- DIN punch for Ø6mm pipes
- DIN punch for Ø8mm pipes
- punch OP0
- punch 45° Ø4.75-5-6mm
- punch 45° Ø8-10mm

SAE : male cone
DIN : female cone



OM 8047

DIN/SAE BRAKE LINE REPAIR KIT

Accessory of SA 8056/SA 8057/SA 8058



No need to remove
the line

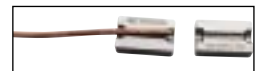

This tool lets you reshape brake line collars. It produces single or double SAE or DIN shapes on 4.75mm, 5mm or 6mm lines

SAE : male cone
DIN : female cone



OM 8050BL

10 PCS REPAIR TOOL SAE MALE/FEMALE SET

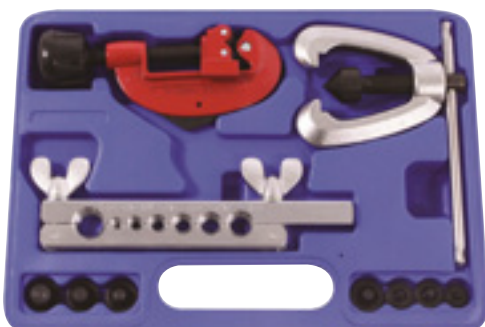

B.LINE



Contents:

- adapters: Ø3/16" (4.75mm)-5/8"-1/2"-7/16"-3/8"-5/16"-1/4"
- tube cutter Ø3 to 30mm

SAE : male cone
DIN : female cone

SA 5323 3/16" ADAPTER

Spare part of OM 8050BL/OM 8050





Non-return valve
for single operator
purging

OM 0501

**SET OF 6 BRAKE/CLUTCH BLEED
WRENCHES**

Specially designed for bleeding brake calipers, the key is equipped with a coupler with retaining gasket, ensuring optimum grip of the bleeding screw (even damaged) without any leakage.

Specifications:

- wrenches 7, 8, 9, 10, 11 and 12mm
- SA2113: hose L.105cm



OM 0220

VICE GRIP 200mm



Ø8 to
Ø20mm



OM 8157

BRAKE HOSE RECTIFIER

Allows easy rectifying of copper brake hoses supplied as a coil.



- knurled handle for a better grip.
- delivered with 3 interchangeable adapter sets: 4.75mm (3/16"), 6.35mm (1/4") and 8mm (5/16")



OM 8090

MINI TUBE CUTTER Ø3-22mm



OM 8057

**MANUAL BRAKE LINE
BENDER Ø3-Ø4-Ø6mm**



EG 0565

**COPPER CROWN Ø4.75mm
L.7.62m**



EG 0007

ASSORTED POPULAR BRAKE LINE FITTINGS BOX 135 PCS



Contents:

- SA0771: Brake lines connectors M10x1 Ø4.75mm stepped base L.16mm 50 pcs
- SA0772: Brake line nuts M10x1 Ø4.75mm 15 pcs
- SA0773: Brake line connectors M10x1 Ø4.75mm L.16mm 20 pcs
- SA0774: Brake line connectors M10x1 Ø4.75mm stepped base L.22mm 20 pcs
- SA0775: Brake line nuts UNF 3/8" Ø4.75mm 10 pcs
- SA0776: brake line connector UNF 3/8"Ø4.75mm stepped base L.20mm 20 pcs



Allows the brake caliper screws to be fitted and removed without removing the coupling lever.

**OM 0418**

3/4" E18 STRIKING WRENCH L.219mm

Applications: Man TGL/TGM

OM 0420

3/4" E20 STRIKING WRENCH L.219mm

Man TGL/TGM

OM 0424

3/4" E24 STRIKING WRENCH L.219mm

Man TGA/TGS/TGX

3/4" drive for use with torque wrench.
Integrated torque and effective length calculation rule.



Allows the brake caliper screws to be fitted and removed without removing the coupling lever.

**OM 0423**

3/4" M24 STRIKING WRENCH L.219mm

SAF

OM 0426

3/4" M26 STRIKING WRENCH L.219mm

DAF XF95/XF105/196

3/4" drive for use with torque wrench.
Integrated torque and effective length calculation rule.

**OM 4526**

2 FEMALE TORX SOCKETS FEMALE E20-E24
D. FOR BRAKE CALIPER MAN



For adjusting brake caliper
Exercice: hexagonal 30mm

**OM 8029**

ABS SEALANT INSTALLATION TOOL VOLVO/
RENAULT

**EG 0809**

LIFT TROLLEY WITH SCISSORS 800kg
(HGV DRUM HOLDERS)



Features:

- min. height: 150mm
- max. height: 800mm
- length: 960mm
- width: 325mm



OH 8001

HGV BRAKE CALIPER SUPPORT

Specially designed for dismantling or changing brake calipers, bushings and drums on trucks, buses and industrial vehicles.
 Reduces working time by up to 70%.
 Limits the risk of accidents (back injury, fall of the stirrup on the feet... etc).

For optimal operation, the recommended methodology is (ex.: disk replacement):
 1- use of the OH 8001 brake caliper support to maintain the initial position
 2- use of the OH 8010 hub/caliper support to extract the assembly
 3- possible use of the OH 8012 disc extractor by cylinder in a case of force majeure



NEW



Only 1 operator



- Specifications:**
- stroke: 200mm
 - 4 wheels (2 swivelling wheels)

- 4 positions caliper grip:
- 1' (12H)
 - 2' (10H/2H)
 - 3' (9H/3H)
 - 4' (Specific with the offset rod for Mercedes).



OH 8002**HGV HIGH ELEVATION BRAKE CALIPER SUPPORT**

Specially designed for dismantling or changing brake calipers, bushings and drums on trucks, buses and industrial vehicles.

Reduces working time by up to 70%.

Limits the risk of accidents (back injury, fall of the stirrup on the feet... etc).

**NEW**

Only 1 operator

**Specifications:**

- stroke: 900mm
- max. winch load: 50kg
- 6 wheels including 2 braked swiveling wheels
- 4 positions caliper grip : 8am/9am/10am/12pm

2
WARRANTY**OH 8012****BRAKE DISC EXTRACTION JACKS**

Specially designed to separate the discs from the hub in record time when they are stuck by corrosion.

Reduces working time and secures the operation by avoiding the use of hammers, discers, cutting machines...

Limits the risk of accidents.

**NEW****Specifications:**

- 2 independent 11T cylinders
- hoses length 2m
- 4 wheels including 2 braked castors

2
WARRANTY

OH 8010

HUB/CALIPER AND BRAKE DRUMS SUPPORT

Specially designed to accommodate the entire hub (hub, disc and caliper) when changing bearings on trucks, buses and industrial vehicles. The assembly can be dismantled directly on the support, without effort, assisted by a winch for the removal of the bracket and disc. Reduces working time by up to 70%. Limits the risk of accidents (back injury, fall of the stirrup on the feet...).



NEW

Specifications:

- stroke: 200mm
- max winch load: 120kg
- 6 wheels including 2 braked castors

For optimal operation, the recommended methodology is (ex.: disk replacement):

- 1- use of the OH 8001 brake caliper support to maintain the initial position
- 2- use of the OH 8010 hub/caliper support to extract the assembly
- 3- possible use of the OH 8012 disc extractor by cylinder in a case of force majeure



OH 8011**HUB/CALIPER AND BRAKE DRUMS HIGH ELEVATION SUPPORT**

Specially designed to accommodate the entire hub (hub, disc and caliper) when changing bearings on trucks, buses and industrial vehicles.
 The assembly can be dismantled directly on the support, without effort, assisted by a winch for the removal of the bracket and disc.
 Suitable for lifted vehicles.
 Reduces working time by up to 70%.
 Limits the risk of accidents (back injury, fall of the stirrup on the feet...).

**NEW****Specifications:**

- max. load: 120kg
- stroke: 500mm
- max winch load: 120kg
- 6 wheels including 2 braked castors
- weight: 58kg

2
WARRANTY



STEERING/SUSPENSION

BALL JOINT

OM 2510BL

3 BALL JOINT PULLER SET Ø23 TO Ø34mm

B.LINE



Ø34 H.63mm
Ø28 H.55mm
Ø23 H.55mm



OM 2501BL	BALL JOINT PULLER Ø23mm	Spare part of OM 2510BL
OM 2502BL	BALL JOINT PULLER Ø28mm	Spare part of OM 2510BL
OM 2503BL	BALL JOINT PULLER Ø34mm	Spare part of OM 2510BL



OM 2600BL

BALL JOINT SEPARATOR
Ø18mm

B.LINE



Specifications:

- to remove rod ends
- suitable for most light vehicles-
- width opening: 20-50mm
- drive profile: 19mm (removal), 22mm (height adjustment)



OH 5020

HYDRAULIC BALL JOINT PULLER KIT
Ø30-34-40mm

8T force



OM 0349

BALL JOINT PULLER Ø35mm



Suitable for Mercedes Sprinter and VW LT



OM 0344

BENZ ACTROS PITMAN ARM PULLER Ø42mm



Suitable for Mercedes Actros et Man 414

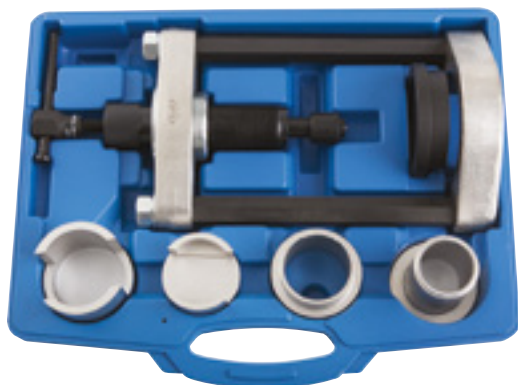

OM 3615

10T UNIVERSAL BALL JOINT/
SILENT-BLOCK REMOVER

Accessory of OM 2511/OM 2512/OM 9387

Supplied with universal rings

Compatible with BMW E36



OM 4533

EPL IMPACT SOCKET 32mm 3/4" L.90mm
MERCEDES



OM 4532

EPL IMPACT SOCKET 32mm 3/4" L.50mm
MERCEDES





STEERING ROD

OM 9330

DOUBLE DRIVE TIE ROD MASTER WRENCH



This wrench is made to install and remove ball joints with no need to remove the steering rack. It is made up of two reversible serrated drives for perfect removal meaning that it is not necessary to pay attention to the direction in which the tool is positioned.

It can be used with traditional 1/2" D. ratchets and extensions. Thanks to its capacity range (30 to 40mm), it is suitable for all types of cars and LCVs.



OM 9175

TIE-ROD ASSEMBLER/REMOVER Ø30-Ø45mm WITH INTERCHANGEABLE HEADS 4PCS

Allows the quick and professional installation and removal of axial steering rack from 30 to 45mm. The heads consist of a cage with three rollers made of treated steel. The rotation of the tool causes the rollers to lock themselves between the tool body and the ball joint, allowing the axial ball joint to be screwed in and out without damaging it.

Compatible with round, hexagonal or octagonal racks.



Head equipped with a retaining screw
3 in 1

Specifications:

- Ø head 30-35mm: 72mm
- Ø head 35-40mm: 78mm
- head Ø40-45mm: 90mm
- the head is retained in place using screws for greater security
- 1/2" drive + 32mm hexagonal for greater force
- length including head: 410mm (Hollow)
- weight: 2kg



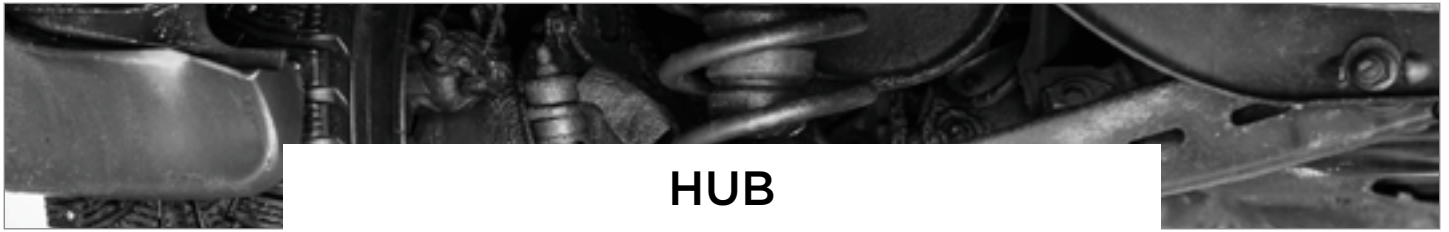

HUB

OP 1480

PNEUMATIC CHISEL TOOLS

Chisel set for an easier removal of corroded, seized or crimped parts.



Contents:

- SA1480: chipping/chisel hammer
- SA1481: adapter for 1/2" D. impact sockets
- SA1482: adapter for Ø38-63-74mm blocks
- SA1483: circular shaped block Ø38mm
- SA1484: rounded hollow block Ø63mm
- SA1485: circular shaped block Ø74mm
- SA1486: circular shaped block Ø25mm
- SA1487: rounded hollow block Ø25mm
- SA1488: 10pcs O-rings

Specifications:

- capacity: 2200bpm
- operating pressure: 5 to 8bar
- consumption: 114l/min
- noise level 100dB

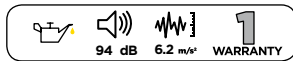

OM 7820

STEERING GEARBOX PULLER



OM 0345

FRONT WHEEL HUB REMOVER MAN Ø166mm



OH 0579

HYDRAULIC PULLER FRONT AXLE SPACER MERCEDES/MAN



OH 0011

HYDRAULIC PUMP 24V 0-40bar



For brake bleed, clutch system and hydraulic gearshift control HPS2, as well as the system with the new compensation tank. Pressure regulator 0-4bar.



OH 0017

HYDRAULIC CONNECTION KIT VOLVO/SCANIA/RENAULT

Accessory of OH 0011



OH 0019

HYDRAULIC CONNECTION KIT MAN

Accessory of OH 0011



OH 0018

HYDRAULIC CONNECTION KIT IVECO

Accessory of OH 0011



OH 0570

SWIVEL PRESS 100T+PUNCHES



Contents:

- 180° swivelling press on mobile trolley with handling handle
 - hydropneumatic pump 700bar suitable for body repair/lifting/ extraction hydraulic rams
 - flexible hose L. 200cm
- Punches:
- Diam. 21,5x150mm
 - Diam. 24,5x150mm
 - Diam. 29x120mm
 - Diam. 29x220mm
 - Diam. 35x120mm
 - Diam. 39x150mm
 - Diam. 39x220mm
- MERCEDES ACTROS-SK-0404 ring
 - reduction washer 35/25mm
 - reduction washer 70/65mm

Inner press frame dimensions: 250x600mm





SHOCK ABSORBER

OM 0393

REAR WHEEL SHOCK ABSORBER SOCKET
SCANIA OUTER Ø56mm



OM 0392

FRONT WHEEL SHOCK ABSORBER SOCKET
SCANIA INNER Ø28mm



OM 0394

REAR WHEEL SHOCK ABSORBER SOCKET
SCANIA OUTER Ø46mm



OM 0395

REAR WHEEL SHOCK ABSORBER SOCKET
VOLVO



OM 0623

NUT SPLITTER



This set allows the operator to quickly remove corroded, seized or damaged nuts.

The principle is simple: the nut is sheared to release the screw thread.

Practical and easy to use, this nut splitter set is a must-have in every workshop.

Contents:

- SA0624: nut splitter for nuts from 9 to 12mm
- SA0625: nut splitter for nuts from 12 to 16mm
- SA0626: nut splitter for nuts from 16 to 24mm
- SA0627: nut splitter for nuts from 22 à 27mm

SA 0624 NUT SPLITTER 9-12mm

SA 0625 NUT SPLITTER 12-16mm

SA 0626 NUT SPLITTER 16-24mm

SA 0627 NUT SPLITTER 22-27mm



OP 3231

PNEUMATIC SPRING COMPRESSOR 3T

Specially designed to fit and securely hold coil springs wide apart. Thanks to the innovative articulation system, the adjustment is automatic when the spring is compressed.



Specifications:

- compression force: 3000kg
- stroke : 330mm
- operating pressure : 6bar/max. 10bar
- dimensions: H.1800xL.871xl.690mm
- operating and maintenance instructions
- color: grey
- weight: 110kg
- conformity: 2006/42CE

Contents:

- OP2003 : articulated jaws
- SA6904 : 1 cup Ø125 to Ø205mm
- SA6916 : 1 cup Ø78 to Ø130mm
- SA6906 : fall arrest support



OP 2003 ARTICULATED UPPER JAWS



OP 3221**REINFORCED PNEUMATIC SPRING COMPRESSOR WITH ARTICULATED JAWS**

Specially designed to adapt to widely spaced loop springs and securely hold them in place.

Thanks to the innovative articulation system, automatic adjustment takes place when the spring is compressed.

**Specifications:**

- height: 1600mm
- base
Length: 500mm
Width: 300mm
- working pressure
6bar/max 10bar
Compression strength 2452kg
- use and maintenance instruction book.
- color: grey
- allocation:
SA6903: upper lateral jaw
OP2009: 1 cup Ø105 to Ø182mm (Mégane, C3, Stylo...)
SA6916: 1 cup Ø78 to 130mm
SA6906: fall protection
- weight: 70kg
- complies with standards 2006/42CE



OP 2003 ARTICULATED UPPER JAWS



OM 1100

SPRING COMPRESSOR 1500kg



Table of applications on request

This suspension spring compressor is suitable for passenger cars and vans. Its robust design and construction allows you clamp it into a vice for easy working, it can be used with an impact wrench. The coating on its compression cups protects the springs, and safety pins prevent any slippage.



Contents:

- 1 spring compressor 1500kg
- 2 pairs of cups Ø80-145mm and Ø145-195mm

Max. opening: 360mm
 Min. opening: 65mm
 TUV certified

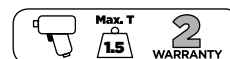

OM 1101 PAIR OF CUPS CITROEN C15 (REAR SHOCK-ABSORBER)

OM 1103 2 CUPS Ø80/120mm

OM 1104 CONICAL SPRING CUP

OM 1105 CUP BMW

OM 1107 CUP PEUGEOT 206

OM 1108 CUP MERCEDES CLASSE C

OM 1109 CUP MEGANE 2 AND MERCEDES CLASS E

OM 1114 SPRING LOCKING SECURITY SAWING CABLE L.450mm

OM 1115 CUPS RENAULT TWINGO III (2014)

OM 3637BL

PAIR OF SPRING COMPRESSORS



B.LINE



Specifications:

- 2 long shafts: 330mm, drive 13mm, opening 320mm
- 2 medium shafts: 215mm, drive 13mm, opening 200mm
- 2 short shafts: 175mm, drive 19mm, opening 170mm
- Jaws width 100mm, depth 13mm
- Ømax spring: 16mm



OM 0784**TORQUE WRENCH WITH INTERCHANGEABLE HEADS 3/8" D. 30-110Nm 331mm**

Heads: 10-11-12-13-14-15-16-17-18-19
Conform DIN ISO 6789 2017-1

Delivered with
calibration certificate

2
WARRANTY

OM 1112**SHOCK ABSORBER HEAD REMOVAL KIT**

This kit is specially designed for installing and removing shock absorber heads. Its go-through socket wrench lets you release or tighten the top cup nut while holding the damper piston steady to prevent it turning.

**Contents:**

- SA1132: ratchet wrench with loops 21mm
- SA1163: hex go-through socket 16mm L.82mm 1/2"
- SA1164: hex go-through socket 17mm L.82mm 1/2"
- SA1165: hex go-through socket 18mm L.82mm 1/2"
- SA1166: hex go-through socket 19mm L.82mm 1/2"
- SA1167: hex go-through socket 21mm L.82mm 1/2"
- SA1168: hex go-through socket 22mm L.82mm 1/2"
- SA1169: hex go-through socket 24mm L.82mm 1/2"
- SA1170: hex socket bit 6mm L.123mm 1/2"
- SA1171: hex socket bit 7mm L.123mm 1/2"
- SA1172: hex socket bit 8mm L.123mm 1/2"
- SA1173: hex socket 7mm L.123mm 1/2"
- SA1174: hex socket 8mm L.123mm 1/2"
- SA1175: hex socket 9mm L.123mm 1/2"
- SA1176: torx socket bit T50 L.123mm 1/2"
- SA1177: slotted socket bit 5x8 L.123mm 1/2"
- SA1178: slotted socket bit 6x8 L.123mm 1/2"
- SA1179: slotted socket bit 7.1x9.6 L.123mm 1/2"

2
WARRANTY

EXTRACTION

SILENT-BLOCK

OM 9386

HYDRAULIC PRESS TOOL SET 18T

Universal tool for silent-block, ball joint, bearings or sealing shaft.



This hydraulic press tool set allows for faster removal and reinstallation, efficient, accurate for safe work. No need to put down chassis components like suspension arms or undercarriages. You can work directly on the vehicle and save a lot of time on labor.

The OM 9386 set presents long (110mm) and short (40mm) bushes of different diameters (26 to 60mm) and also a 18T hydraulic cylinder which facilitates the extraction of parts to be replaced.

Contents:

- SA9382: hydraulic pump with pressure cups
- SA9389: Threaded rod M20x350 (with o ring to block the sockets)
- SA9383: pressure adapter
- set of 22 short bushes (40mm)
- set of 22 long bushes (110mm)
- plastic case
- SA4215: 1/4"-3/8" adapter

Specifications:

- internal length (press frame): 290mm
- internal width (press frame): 110mm
- maximum load of press frame: 14T
- maximum load of hydraulic cylinder: 18T

Max. T
18

2
WARRANTY

OM 9385

HYDRAULIC EXTRACTION SET

Contents:

- SA9384: hydraulic cylinder 18T with 3/8" adapter
- SA9385: push spindle M10x1.5
- SA9386: push spindle M12x1.75
- SA9387: push spindle M14x1.5
- SA9388: push spindle M16x2.0
- 22 short bushes (40mm)
- 22 long bushes (110mm)
- plastic case
- SA4215: 1/4"-3/8" interface connector

Max. T
18

2
WARRANTY

OM 9383**18T HYDRAULIC PRESS PACK + HYDRAULIC AIR PUMP/HOSE/CONNECTOR**

Universal tool for silent blocks, ball joints, bearings or sealing rings. This pack allows you to remove and reinstall them quickly, efficiently and precisely in a very safe manner.

Without any need to remove the chassis components such as the suspension arm or the undercarriage, it allows you to work directly on the vehicle and save a considerable amount of time on the labor.

It includes a hydraulic press set with pressure support sockets (L.40mm and L.110mm) with diameters of between 26 and 60mm and an 18T cylinder + 4 extraction rods of 10-12-14-16mm which facilitate the extraction of the parts for replacement.

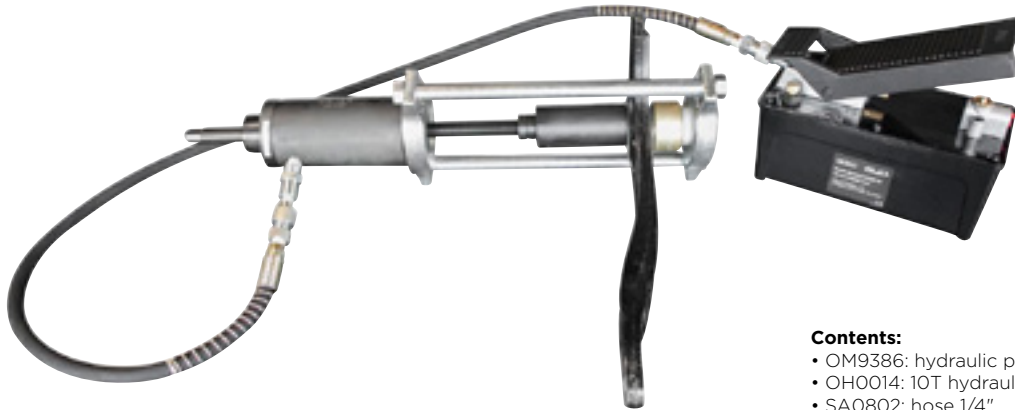
**Contents:**

- OM9386: hydraulic press set
- OH0014: 10T hydraulic air pump 1/4"
- SA0802: hose 1/4"
- SA0803: female hydraulic adaptor
- SA4215: hydraulic adaptor 1/4"-3/8"

**SA 9382****HYDRAULIC PUMP WITH FRAME AND SPINDLES**

Spare part of OM 9385/OM 9386/OM 9387/OM 9287

Accessory of OM 2511/OM 2512/OM 2518/OM 3616



Easy, without strain

The hydraulic press enables extraction and setting up of silent-blocks and hubs directly on the vehicle without even removing the car frame. The cylinder must be coupled with manual pump SA0808 or hydropneumatic pump OH0014 and an hydraulic adapter SA4215.

**OM 5023****UPPER/LOWER HUB RENAULT/OPEL EXTRACTION RING SET**

Accessory of OM 3615/OH 0820/OH 0830/OH 0430

For Renault Master, Opel Movano, Nissan Interstar

**Contents:**

- OM2511: bottom hub extraction rings Renault/Opel
- OM2512: upper hub extraction rings Renault/Opel

Compatible with OM3615 and workshop presses.



OM 9373

18T HYDRAULIC EXTRACTION PACK + HYDRAULIC AIR PUMP/HOSE/CONNECTOR

Universal tool for silent blocks, ball joints, bearings or sealing rings. This pack allows you to remove and reinstall them quickly, efficiently and precisely in a very safe manner.

It includes a hydraulic extraction set with pressure support sockets (L.40mm and L.110mm) with diameters of between 26 and 60mm and an 18T cylinder + 4 extraction rods of 10-12-14-16mm which facilitate the extraction of the parts to be replaced.



Contents:

- OM9385: hydraulic extraction set
- OH0014: 10T hydraulic air pump 1/4"
- SA0802: hose 1/4"
- SA0803: hydraulic female connector
- SA4215: hydraulic adaptor 1/4"-3/8"



OM 9384

18T HYDRAULIC EXTRACTOR

Accessory of OM 3420/OM 3424/OM 3425/OM 3426/OM 3427/OM 3428/OM 3429/OM 3430/OM 9387/OM 3417

Hollow ram for extraction and replacement of silent-blocks, ball joints, side shafts, crank shafts, wheel bearings.

Easy, without strain



Contents:

- SA9384: 18T hydraulic extraction ram
- SA9385: threaded rod M10x1.5
- SA9386: threaded rod M12x1.5
- SA9387: threaded rod M14x1.5
- SA9388: threaded rod M16x1.5
- SA4215: 1/4"-3/8" hydraulic adapter

- Options:
- SA0808: manual pump
 - OH0014: hydropneumatic pump

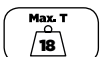

OM 9387

20 LARGE Ø SOCKET SET

Accessory of OM 9385/OM 9373/OM 9386/OM 9383/OM 9382



Contains 10 black long socket (L. 100mm) and 10 gold short socket (L. 30mm) with different diameters (70 to 88mm).



OM 9370

SILENT-BLOCK STAB. BAR EXTRACTOR Ø70mm MERCEDES ACTROS

Accessory of OM 9384/OM 9385



OM 9391

SILENT BLOCK EXTRACTOR SAF Ø158mm



SK INTRAAX XO/XU

Silent-block dimensions: 155/32x114
Silent-block OEM code: 4177302800A



OH 3512

GO-THROUGH MECHADRAULIC CYLINDER 12T+ADAPTERS

Accessory of OM 9381



Specifications:

- force: 12T
- stroke: 8mm
- tightening torque max: 56Nm

Supplied with adapters M10, M12, M14, M16, M18x1.5



OM 9381

HGV SILENT-BLOCK PULLER/INSTALLATION SET

Allows the extraction and installation of split silent-blocks, which need to be compressed to be installed.



Applications of half-rings + support ring:

- Ø56mm: Iveco Eurostar (Cabin)
- Ø58mm: Mercedes 3229B, 650,652 and Volvo
- Ø60mm: Mercedes and Iveco Eurostar (stabilizer), Renault Kerax, Magnum, Premium (blade spring)
- Ø63mm: DAF
- Ø65mm: Mercedes Actros (stabilizer) and Atego
- Ø66mm: Iveco Eurostar (cabin)
- Ø68mm: Man (front), ROR, SAF
- Ø70mm: Man
- Ø75mm: Mercedes Actros (stabilizer)

Contents:

- support sockets (long and short) small diameter
- support sockets (long and short) large diameter
- 9 sets of half-rings + support ring
- silent-block compression vice
- extraction rod M20 + Nuts
- spacer for mechanical-hydraulic cylinder
- 1 step stop



OM 9388

SILENT-BLOCK UNIVERSAL EXTRACTION KIT



SA 9289 THREADED ROD M10x1.5 L.350mm+NUT

SA 9290 THREADED ROD M12x1.5 L.350mm+NUT

SA 9291 THREADED ROD M14x1.5 L.350mm+NUT

SA 9292 THREADED ROD M16x1.5 L.350mm+NUT

Contents:

- 6 stepped end caps for cylinders: 34-36-38-40-42-44-46-48-50-52-54-56-58-60-62-64-66-68-70-72mm
- 4 threaded rods Ø10-12-14-16mm
- 2 guided bearings

Stepped end caps and numbered cylinders for easy identification.



OH 0570**SWIVEL PRESS 100T+PUNCHES****Contents:**

- 180° swivelling press on mobile trolley with handling handle
- hydropneumatic pump 700bar suitable for body repair/ lifting/extraction hydraulic rams
- flexible hose L. 200cm
- Punches:
 - Diam. 21,5x150mm
 - Diam. 24,5x150mm
 - Diam. 29x120mm
 - Diam. 29x220mm
 - Diam. 35x120mm
 - Diam. 39x150mm
 - Diam. 39x220mm
- MERCEDES ACTROS-SK-0404 ring
- reduction washer 35/25mm
- reduction washer 70/65mm

Inner press frame
dimensions: 250x600mm



BEARING

OM 3517BL

BEARING INSTALLATION/EXTRACTION KIT



Contents:

- 9 adapters Ø55,5-59-62-65-66-71,5-73-78-84mm
- 3 races Ø76-86-91mm
- 3 thrust screws M12x1,25
- 3 thrust screws M12x1,5
- 3 thrust screws M14x1,5



OM 0479

SHAFT BEARING
INSTALLATION GUIDE
IVECO DAILY



OM 5412BL

KNIVES + CLAWS SEPARATOR SET



B.LINE



Contents:

- 1 separator knife mini 13mm maxi 63mm
- 1 separator knife mini 5mm maxi 65mm
- 2 arms for knives length 60mm
- 2 arms for knives length 80mm
- 2 arms for knives length 104mm
- 2 arms for knives length 128mm
- 2 claws 110mm
- 1 mount for arms/claws width 45-150mm
- 1 pull spindle L.170mm drive 17mm



OM 3423

HYDRAULIC GEAR
PULLER SET 10T

Contents:

- SA3423: 1 10T hydraulic jack
- 2 arm supports 2 and 3 claws
- 3 claws L.230mm
- 3 claws L.170mm
- 3 claws L.120mm
- 2 arms for knife L.180mm
- 2 arms for knife L.235mm
- 1 arm support max. width 160mm
- 1 separating knife, 20mm - 105mm capacity - bearing separator up to Ø105mm
- 1 centerer Ø25mm
- 1. L.50mm extension, head Ø16mm
- 1 extension length 100mm, head Ø16mm

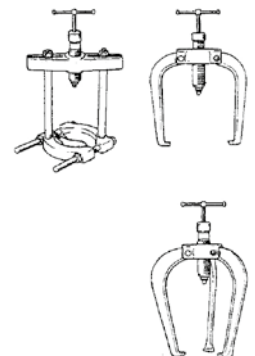

OM 3418

BEARING EXTRACTOR SET INTERNAL GRIP Ø8-Ø58mm



Contents:

- SA3411: slide hammer 1kg L.280mm
- SA3412: coming soon
- SA3413: internal grip tip Ø8-11mm
- SA3414: internal grip tip Ø12-17mm
- SA3415: internal grip tip Ø18-23mm
- SA3416: internal grip tip Ø24-29mm
- SA3417: internal grip tip Ø30-34mm

- SA3418: internal grip tip Ø34-38mm
- SA3419: internal grip tip Ø39-43mm
- SA3425: internal grip tip Ø44-48mm
- SA3426: internal grip tip Ø49-53mm
- SA3427: internal grip tip Ø54-58mm
- SA3428: adapter M10x1.5
- SA3429: reducer M10x1.5-M8x1.25
- SA3430: reducer M10x1.5-M6x1.0



OM 3409

BEARING EXTRACTOR SET INTERNAL GRIP Ø8-Ø32mm



Contents:

- SA3401: impact hammer 1kg L.380mm
- SA3402: 1 internal-grip tip Ø8mm to 10mm
- SA3403: 1 internal-grip tip Ø10mm to 12mm
- SA3404: 1 internal-grip tip Ø12mm to 14mm
- SA3405: 1 internal-grip tip Ø15mm to 17mm
- SA3406: 1 internal-grip tip Ø17mm to 20mm
- SA3407: 1 internal-grip tip Ø20mm to 24mm
- SA3408: 1 internal-grip tip Ø25mm to 29mm
- SA3409: 1 internal-grip tip Ø30mm to 32mm



Long-term protection

CO 1026

SUPER RELEASING GRAPHITE SPRAY 400ml

Thanks to its very low surface tension graphite formula, this super releasing spray penetrates deeply to erode rust, leaving a protective graphite film. Facilitates future removal.

Releases and protects, minimizes friction and stops rust.



HUB



OM 3455

UNIVERSAL HGV HUB PULLER (5 ARMS)

- Features:
- max. opening diameter: 425mm
 - for nuts M14 to M22
 - force up to 30T



OM 9208

MULTI-BRAND HUB PULLER (CARS & LCV)



Covers most light vehicles & vans (Jumpy, Iveco, Boxer, Master, Trafic, Ducato, Sprinter...)
Applications on demand.

Contents:

- 4 extraction screws M12x1.5
- 4 extraction screws M14x1.5
- 1 mechanical spindle
- disc Ø90 to Ø170mm
- 4.3kg slide hammer



SA 9205 4 PCS WHEEL BOLT SYSTEM (MALE/FEMALE) M12x125

SA 9206 4 PCS WHEEL BOLT SYSTEM (MALE/MALE) M12x125

SA 9207 4 PCS WHEEL BOLT SYSTEM (MALE/FEMALE) M12x150



DRIVE SHAFT

OH 5022

10T HYDRAULIC DRIVE SHAFT PULLER SET



Use with 3,4 and 5 hole vehicle studs Ø16mm max.
for hubs with Ø135 to Ø250mm.

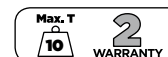

WHEEL

REPAIR/REBUILDING

OM 9344

7 PCS STUD CLEANING KIT

Specially designed for mounting on a drill/screwdriver or impact wrench, the tool allows quick and easy cleaning of studs. Delivered with 6 brushes of different diameters, the change is done in one click!



6 in 1
Brush change
in 1 click



Contents:

- SA9350: brush holder, 1/2" drive
- SA9344: brush Ø12mm
- SA9345: brush Ø13mm
- SA9346: brush Ø14mm
- SA9347: brush Ø16mm
- SA9348: brush Ø22mm
- SA9349: brush Ø28mm
- SA9351: drill/screwdriver adapter



OM 9311

WHEEL STUD THREAD RESTORER HGV

This tool is designed to restore and align damaged threads.

Particularly suitable for wheel studs.

Instructions:

- choose the thread that matches wheel stud
- stretch the thread and place over the base of the stud
- loosen with the thread-holding socket



- M18x1.5mm DAF/IVECO/MAN/Renault/Volvo
 - M20x1.5mm Mercedes/Scania
 - M22x1.5mm DAF/Ford/MAN/Renault/Volvo/Mercedes/Scania
 - 7/8"-11 Scania
 - adapter hex size: 32mm
- The set includes four threads to suit the most common HGV wheel studs thread sizes.



TIGHTNESS/RELEASE

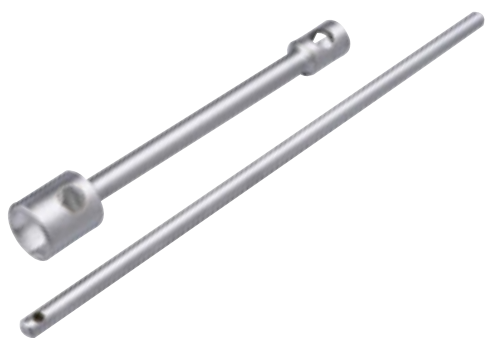

OM 0397

REVERSIBLE EXTENDED WRENCH 27-32mm
Ø25.4mm L.400mm

OM 0396

REVERSIBLE EXTENDED WRENCH 32-33mm
Ø25.4mm L.400mm



Hex
L.300mm

OM 0400

1" D. TORQUE CONTROL IMPACT SOCKET
32mm 450Nm

OM 0401

1" D. TORQUE CONTROL IMPACT SOCKET
32mm 500Nm

OM 0402

1" D. TORQUE CONTROL IMPACT SOCKET
33mm 550Nm

OM 0403

1" D. TORQUE IMPACT SOCKET EXTRA DEEP
33mm 650Nm



OM 7025

5 ALU WHEEL RIM 1/2" IMPACT SOCKET SET

Sheathed impact sockets to avoid rim damage,
colored to enable immediate size identification.
1/2" drive.

Contents:

- SA5015: 15mm impact socket (green)
- SA5022: 17mm impact socket (blue)
- SA5017: 19mm impact socket (gold)
- SA5023: 21mm impact socket (red)
- SA5021: 22mm impact socket (purple)



OM 4535

TORQUE MULTIPLIER R1:58 4800Nm+6
SOCKETS + 2 ADAPTERS 1" HGV

**Contents:**

- torque multiplier R1:58 L.270mm
- extension L.255mm
- sockets 24-27-30-32-33-38mm, H.80mm 1" drive
- adapters 1" female-female and 3/4" male-1" female H.80mm

Torquing and releasing

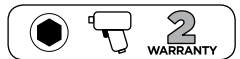
**NEW****OM 0586**

3/4" 17mm WHEEL NUT SQUARE SOCKET L.90mm

OM 0587

3/4" 19mm WHEEL NUT SQUARE SOCKET L.90mm

OM 0588

3/4" 20mm WHEEL NUT SQUARE SOCKET L.90mm

OM 0589

3/4" 21mm WHEEL NUT SQUARE SOCKET L.90mm

**OM 0135**

ANTI-REBOUND HAMMER 4.5kg L.900mm

Allows HGV wheels to be detached when they have adhered to the hub.



- anti-rebound technology
- plastic handle L.780mm
- head dimensions: L.180xW.105xH.105

**OM 0342**

1" D. HEX REAR HUB SOCKET
IRISBUS/VOLVO Ø105mm

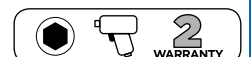
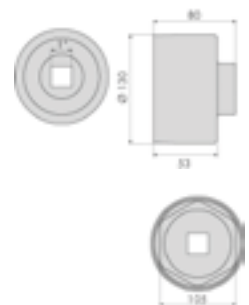
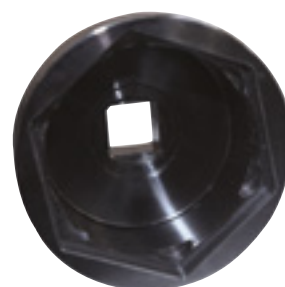

OM 0565

1" D. IMPACT HEX SOCKET Ø65mm



OM 0585

1" D. IMPACT HEX SOCKET Ø85mm



OM 0156

3/4" D. DOUBLE HEX SOCKET Ø56mm FORD TRANSIT

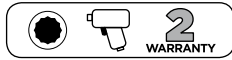

OM 0066

4-PINS REAR HUB SOCKET FORD TRANSIT

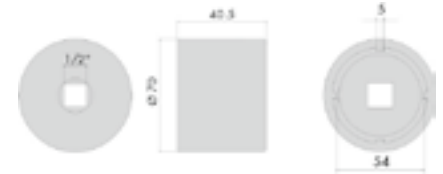

Specially designed for hub nuts to hold wheel bearings in place.

Ford Transit 80,100,115 and 120cv drive with type 34 rear axle.



OM 0567

1" D. IMPACT HEX SOCKET Ø77mm



Renault Mascott 4



OM 0336

HEX HUB SOCKET RENAULT FONTENAC TRAILER Ø160mm

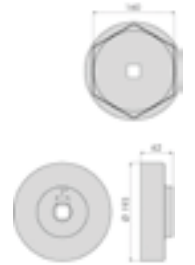
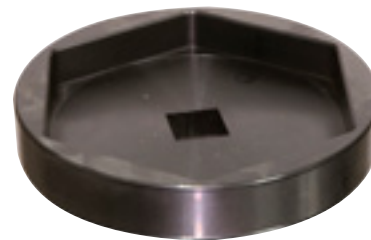

OM 4024

REAR HUB BOLT REMOVAL WRENCH RENAULT/MASCOTT 3/4" D.



OM 0343

8-SIDED SOCKET Ø116mm RENAULT/VOLVO/DAF

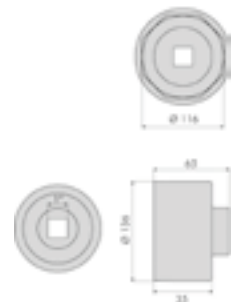

**OM 0319**

6 PIN FRONT HUB SOCKET
MAN Ø76.5mm



Suitable for front axles M3, ME, MI and for rear axles 3MR, 5MR

**OM 0352**

4-PIN MAN TRANSMISSION
SOCKET Ø53.5mm

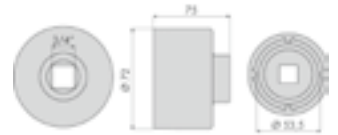
**OM 0306**

6 PIN FRONT HUB SOCKET
MAN Ø92,5mm

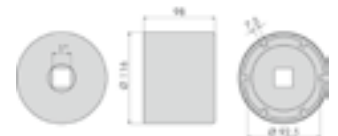

Suitable for Man TGA V9, 82L, 01, F2000

**OM 0384**

6 PIN DRIVE AXLE NUT SOCKET
MAN TGA Ø118mm

Suitable for MAN TGA 460 axles,
V9-82L-01 (disc brakes & ABS).
Removable guide.

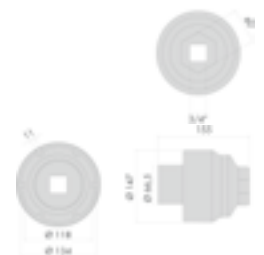
**OM 0318**

6 PIN FRONT HUB SOCKET MAN Ø77mm

Suitable for MAN TGA 460 axles, V9-82L-01
(disc brakes & ABS).
Removable guide.

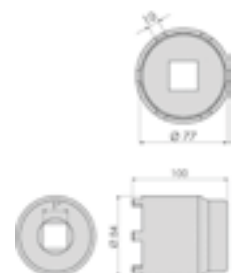



OM 0353

MAN/MERCEDES
DIFFERENTIAL REAR NUT 6
PIN SOCKET Ø113mm

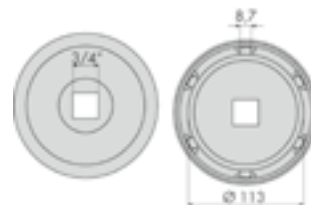

OM 0313

RECTANGULAR HUB SOCKET
MAN/MERCEDES 60x76mm

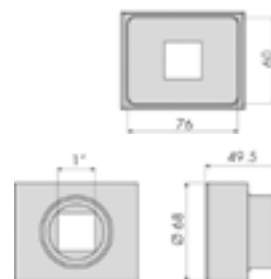

Suitable for DAF, KASSBOHRER/SETRA Man and Mercedes
SK VL5/1 D-9 series 2629 in 6x4, 2635K in 6x4 and 3535K in 8x4



OM 0354

6 PIN SOCKET FOR REAR AXLE NUT MERCEDES CITARO
Ø123.5mm

For ZF car lifts
Pin width: 10.8mm
Hex. drive 32mm



OM 0350

HEXAGONAL SOCKET FOR MERCEDES/EVOBUS
DIFFERENTIAL NUTS Ø72mm

Suitable for Mercedes Citaro et EvoBus, ZF axle 132



OM 0300

6 PIN REAR HUB SOCKETS MAN
BUS Ø110mm

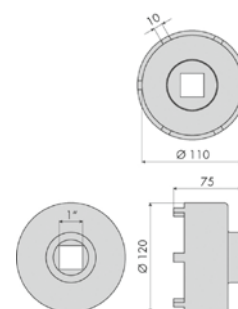

**OM 0322**

6 PIN HUB SOCKET MAN &
MERCEDES Ø117mm

Suitable for rear axles TGA

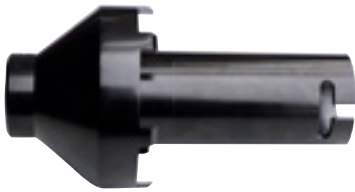
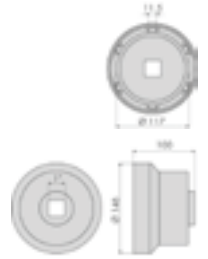
**OM 0386**

6 PIN REAR AXLE NUT SOCKET
MERCEDES/MAN Ø87mm

Suitable for Atego, Vitaro 814 and MAN rear axles.

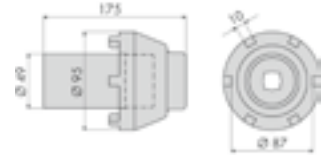
**OM 0387**

6 PIN REAR AXLE NUT SOCKET
MERCEDES/MAN Ø101mm

Suitable for Hypoid and trailer axle NR7/4, Omnibus O305G,
O405G.

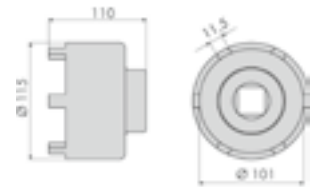
**OM 0388**

6 PIN DRIVE AXLE NUT SOCKET
MAN/MERCEDES Ø101.5mm

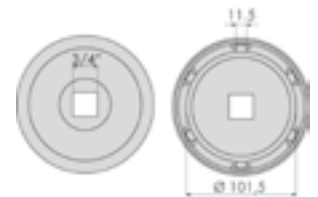
**OM 0321**

12 & 6 PIN REVERSIBLE
HUB SOCKET MAN/
MERCEDES Ø102mm

For models prior to 7TN AL 7/1
For models before 10TN/13TN,
HL 7/0, 7/1, 7/2, 7/3, 7/18, 7/015,
7/021, HO 7/8, 7/9, HD 7/2, 7/19DG,
7/016DG

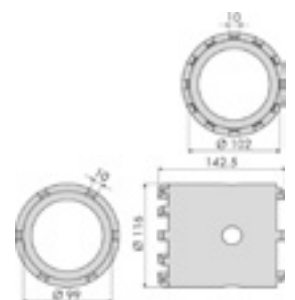



OM 0307

6 PIN REAR HUB SOCKET
MERCEDES Ø71.5mm

Suitable for rear models HL 2/2, 2/7, 2/13

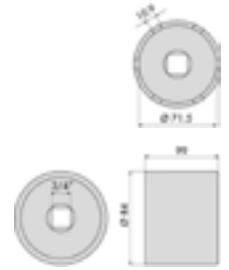

OM 0309

6 PIN REAR HUB NUT SOCKET MERCEDES
Ø75mm

Suitable for front hubs AL 3/1, 3/2, 3/3, 3/4, 3/7, 3/8
For rear hubs HL 2/14, 2/30, KL 2/16, 4/1, 4/4, 4/8, 4/16,
4/17, 4/23, 4/28, 4/29, KD 4/6G, HO 4/2, 4/18, NR 4/4

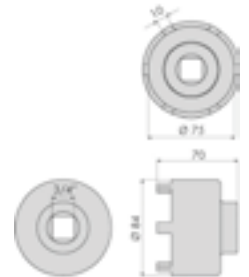

OM 0305

12 PIN REAR HUB SOCKET MERCEDES
Ø90mm

Suitable for Mercedes Actros 1840, rear axle BRG
year 2001

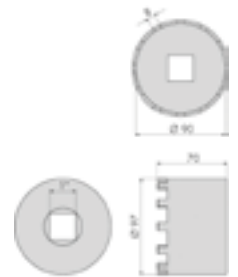

OM 0308

6 PIN TRAILER HUB SOCKET
MERCEDES Ø113mm

Suitable for models NSA/2, NSA/10, HL 6/1, 6/2, 6/3, HD 6/3

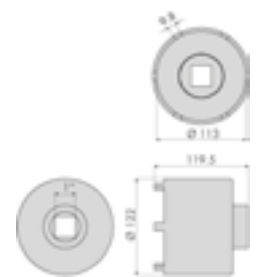

OM 0385

6 PIN REAR AXLE NUT SOCKET BENZ Ø116mm

Suitable for HL/HL8 Actros axles.



**OM 0311**

6 PIN HUB SOCKET
MERCEDES ATEGO Ø101mm

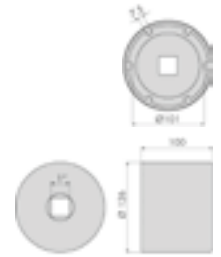
**OM 0301**

HEX MERCEDES HUB SOCKET
Ø95mm

Suitable for axles and trailers

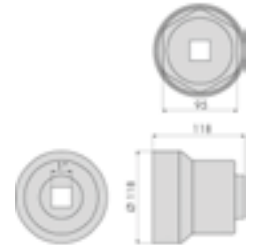
**OM 0307**

6 PIN REAR HUB SOCKET
MERCEDES Ø71.5mm

Suitable for rear models HL 2/2, 2/7, 2/13

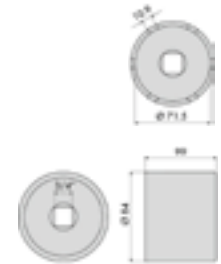
**OM 0312**

RECTANGULAR HUB SOCKET FOR
KASSBOHRER/SETRA/DAF/MERCEDES
56x71mm

Suitable for Kassbohrer/Setra:
Front axles 6.5T and 7.5T on S210, 215, SG 219-221
Rear axles type S216 HDS and S228 DT, 0303, 0305-G, 0307
Daf/Mercedes: VL 3/8, 3/13, 4/7, 4/9, 4/10, 4/15, 4/16, 4/19, VD
4/14, 4/20, type 363, 385, 387, 389, 391, 393, 395, 617, 620, 621,
622, 623, 625, 649
Mercedes-Autobus: VO 3/10, 4/11, 4/13, 4/19 type 0303, 0305-G
and 0307

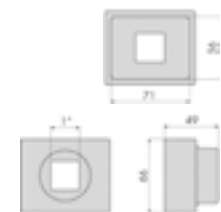
**OM 0350**

HEXAGONAL SOCKET FOR MERCEDES/
EVOBUS DIFFERENTIAL NUTS Ø72mm

Suitable for Mercedes Citaro et EvoBus, ZF axle 132



OM 0341

HEX HUB SOCKET IVECO Ø90mm 1" D.

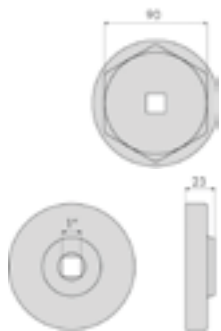
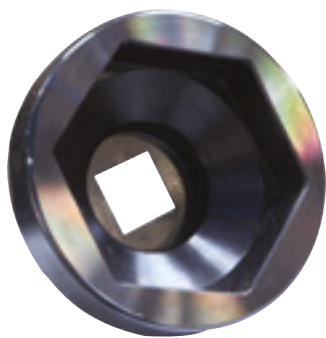

Suitable for Iveco Cargo HA>98

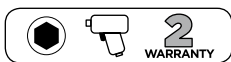

OM 0331

DOUBLE HEX HUB SOCKET IVECO Ø85mm

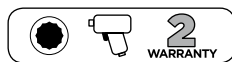
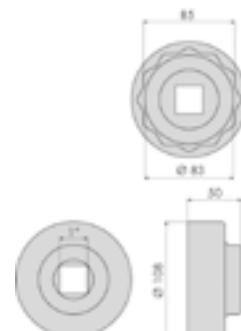

OM 0382

IVECO AXLE NUT SOCKET 98mm HEX



Suitable for Iveco Eurocargo

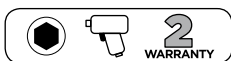

OM 0383

AXLE NUT SOCKET IVECO 110mm DOUBLE HEX



Suitable for IVECO Eurotech Cursor HA.



OM 0479

SHAFT BEARING INSTALLATION GUIDE IVECO DAILY



**OM 4480**

8-SIDED FRONT HUB NUT
SOCKET SCANIA Ø80mm

Scania 124L, 144L, series
4<96

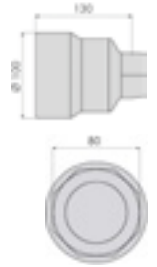
**OM 0324**

4 PIN REAR AXLE SOCKET
SCANIA Ø91mm

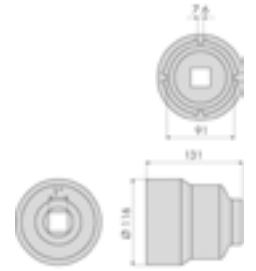
**OM 4100**

8-SIDED REAR HUB NUT
SOCKET SCANIA Ø100mm
3/4"

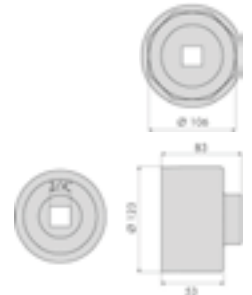
**OM 0351**

4-PIN SCANIA TRANSMISSION
SOCKET Ø63-64mm

Suitable for Scania 310, 320

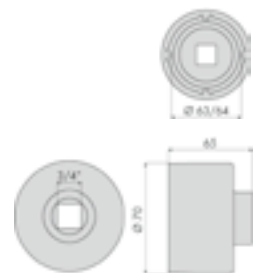
**OM 0389**

GROOVE NUT SOCKET WITH 8 STUDS SCANIA 420
Ø103mm

Specific for SCANIA 420 Heavy duty tipper.





OM 0370

3/4" ROLLER BEARING AXLE NUT SOCKET BPW
6.5/9T 65mm



OM 0334

HUB SOCKET BPW TRAILERS
6.5-9T

Suitable for axles 6.5-9T type H, R, N, ECO H/K/N,
ECO-MAXX H/K/N, ECOPlus H, ECOPlus 2 H/KH

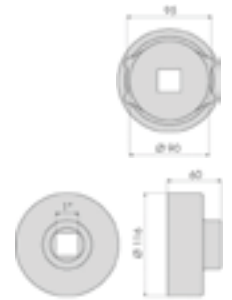

OM 0335

HUB SOCKET BPW
TRAILER 12T

Suitable for axles 12T type H, R, K, N, ECO H/
KH/N, ECO-MAXX H/KH/N, ECOPlus H/KH

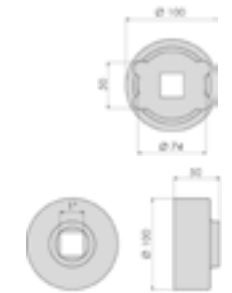

OM 0371

3/4" ROLLER BEARING AXLE NUT
SOCKET BPW 12T 80mm



OM 0373

REAR HUBCAP NUT SOCKET
BPW 12T 109mm 8-SIDED

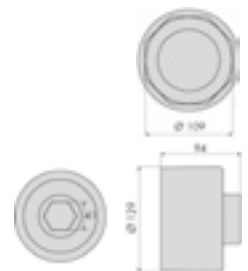



OM 0374
 REAR HUBCAP NUT
 SOCKET BPW 12T 111mm

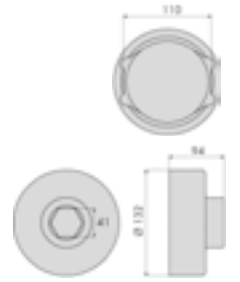

OM 0372
 3/4" ROLLER BEARING AXLE NUT
 SOCKET BPW 16T HEX

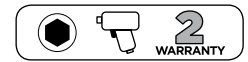
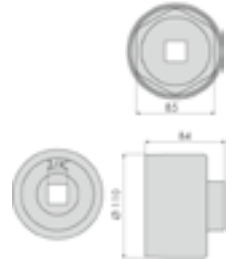

OM 0375
 REAR HUBCAP NUT SOCKET
 BPW 16T 110mm 8-SIDED

Suitable for the new BPW 16T axles

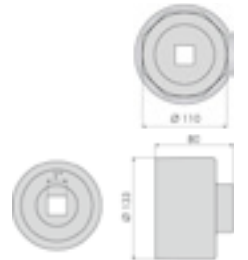

OM 0333

HEX REVERSIBLE HUB SOCKET FRUEHAUF TRAILERS 123mm/110mm

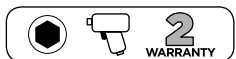

OM 0376

AXLE TRAILERS NUT SOCKET SAF 85mm HEX

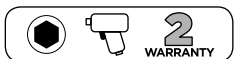

OM 0332

HEX HUB SOCKET RENAULT/SAF Ø140mm



OM 0330

8-SIDED HUB SOCKET R.O.R TRAILERS 84mm



OM 0329

8-SIDED HUB SOCKET R.O.R TRAILERS 127mm



OM 0377

WHEEL CAPSULE AND AXLE NUT SOCKET 65mm 3/4"

OM 0378

WHEEL CAPSULE AND AXLE NUT SOCKET 80mm 3/4"

OM 0379

WHEEL CAPSULE AND AXLE NUT SOCKET 85mm 3/4"

OM 0380

WHEEL CAPSULE AND AXLE NUT SOCKET 111mm 3/4"

OM 0381

WHEEL CAPSULE AND AXLE NUT SOCKET 120mm 3/4"



OM 0355

UNIVERSAL HGV HUB COVER REMOVAL TOOL

- from Ø47mm to Ø145mm
- 3/4" D.
- 3 sets of pins for castle nuts

Supplied with OM0045: 1/2"x 3/4" increaser



WHEEL BALANCERS/ TIRE CHANGERS HANDLING

OH 9001

WHEEL DOLLY HGV



Mounted on 3 swiveling wheels
Lifts wheel using hydraulic piston (max. 650kg)



OH 9000

WHEEL DOLLY HGV/PUBLIC WORKS/
AGRICULTURAL



Wheel diameter up to
2200mm

Wheel lifting by hydraulic cylinder
(1200kg maximum).

Specifications:

- height: min.1375mm-max.2175mm
- length: 940mm
- width: min.1200mm-max.1970mm
- ground clearance: 175mm
- roller length: 500mm
- space between rollers: min.720mm-max.1250mm
- rollers: Ø76mm
- capacity wheel Ø: min.1000mm-max.2200mm
- depth of wheels: 800mm maximum
- dolly wheels: 4 big wheels PU Ø145x50mm including 2 swivel wheels with brakes



OM 9002

TIRE LIFTING DOLLY HGV



- arm width: 500mm
- depth: 350mm



EG 011

PNEUMATIC CARRIAGE TROLLEY



Specifications:

- tray Ø640mm
- max. load: 150kg
- 4 steering castors, 2 of which are braked
- weight: 5.5kg
- dimensions: 640x640x175mm



TIRE CHANGER

721428.10

HGV TIRE CHANGER <56" 2 SPEED SYSTEM 7256

Electro-hydraulic tire changer for trucks, buses, construction and agricultural vehicles, clamping range up to 56".

Precise and powerful assembly: up, down and clamping by 4 electro-hydraulic arms/jaws, rotation of the centering claw by electric drive

Vigorous calibration: hydraulic longitudinal displacement of the carriage

Working comfort: mounting arm on trolley with hydraulic adjustment, pivoting and automatic folding

Adaptability of use: 2 rotation speeds of the clamping claw (4 and 8 rpm)

High variability: assembly/disassembly of wheels up to a Ø of 2.21 m

Easy to use: mobile control unit, equipped with joystick and pedal

Supplied with: claw extension, mounting lever and mounting clamp for aluminum rims

Optional accessories for aluminium rims

NEW

Agriculture and civil works

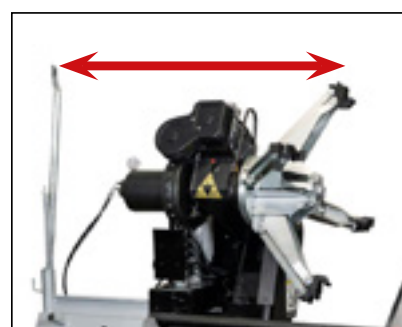

Complete longitudinally adjustable drive unit



Specifications:

- wheel Ø max.: 2550mm
- bead breaker force: max. 8000kg
- mounting speeds: 2
- chuck speed: 4 bzw. 8 rpm
- operating pressure: Max. 250 bar
- power supply voltage (electrical): 3/400V/50Hz
- clamping range: 135 - 1155mm
- clamping capacity (with extension): 710 - 1550mm
- wheel width max.: 1130mm
- rim Ø: 56"



Accessories: visit our website



721436

HGV TIRE CHANGER <56" 1 SPEED SYSTEM M156

Electro-hydraulic tire changer for trucks and buses, clamping range up to 56".
 Precise and powerful assembly: up, down and clamping by 4 electro-hydraulic arms/jaws, rotation of the centering claw by electric drive
 Vigorous calibration: hydraulic longitudinal displacement of the carriage
 Intuitive operation: mounting arm on trolley with adjustment, swivel and manual folding
 Easy to use: mobile control unit, equipped with joystick and pedal
 Supplied with: mounting lever and mounting clamp for aluminium rims and claw extension
 Especially suitable for trucks and buses up to 56".
 Optional accessories for aluminum rims

 Accessories: visit our website

NEW



Rotation of the centering claw by hydraulic drive

Lockable mounting finger

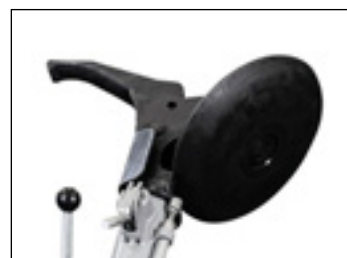

HGV and buses

Specifications:

- max wheel Ø: 2500mm
- calibration force: max. 4000kg
- mounting speeds: 1
- chuck speed: 6 rpm
- operating pressure: 125 bar
- electrical drive voltage: 400 V
- clamping range: 135 - 1.155mm
- max. torque 750 Nm
- product weight: 834kg
- rim Ø: 56"



 **400V**  **2** WARRANTY



721426.10

HGV TIRE CHANGER <26" 1 SPEED SYSTEM 7226

Electro-hydraulic tire changer for trucks and buses, clamping range up to 26".
 Precise and powerful assembly: up, down and clamping by 4 electro-hydraulic arms/jaws, rotation of the centering claw by electric drive
 Vigorous calibration: hydraulic longitudinal displacement of the carriage
 Intuitive operation: mounting arm on trolley with adjustment, swivel and manual folding
 Easy to use: mobile control unit, equipped with joystick and pedal
 Supplied with: mounting lever and mounting clamp for aluminium rims
 Optional accessories for aluminum rims

Accessories: visit our website

Trailers and carriers

NEW



Centering claw with 4 hydraulic arms



Specifications:

- max wheel Ø: 1550mm
- calibration force: max. 3000kg
- mounting speeds: 1
- chuck speed: 7 rpm
- operating pressure: Max. 200 bar
- electrical drive voltage: 3/400V/50Hz
- clamping range: 120 - 725mm
- maximum wheel width: 780mm
- product weight: 834kg
- rim Ø: 26"
- machine dimensions (WxDxH): 2030x1590x1000mm

400V WARRANTY 2

721435**HGV TIRE CHANGER 19"-26" M126**

Electro-hydraulic tire changer for trucks and buses, clamping range up to 26".
 Precise and powerful assembly: up, down, clamping by 4 jaws and rotation of the centering claw by electro-hydraulic control
 Vigorous calibration: hydraulic displacement of the carriage with two different calibration rollers
 Intuitive operation: mounting arm on a trolley with manual swivel and hydraulic angle adjustment
 Easy to use: mobile control unit, equipped with hydraulic valves
 Supplied with: lever and mounting clamp
 Optional accessories for aluminum rims



Accessories: visit our website

NEW

Calibration rollers



Swiveling mounting finger



Clamping jaws

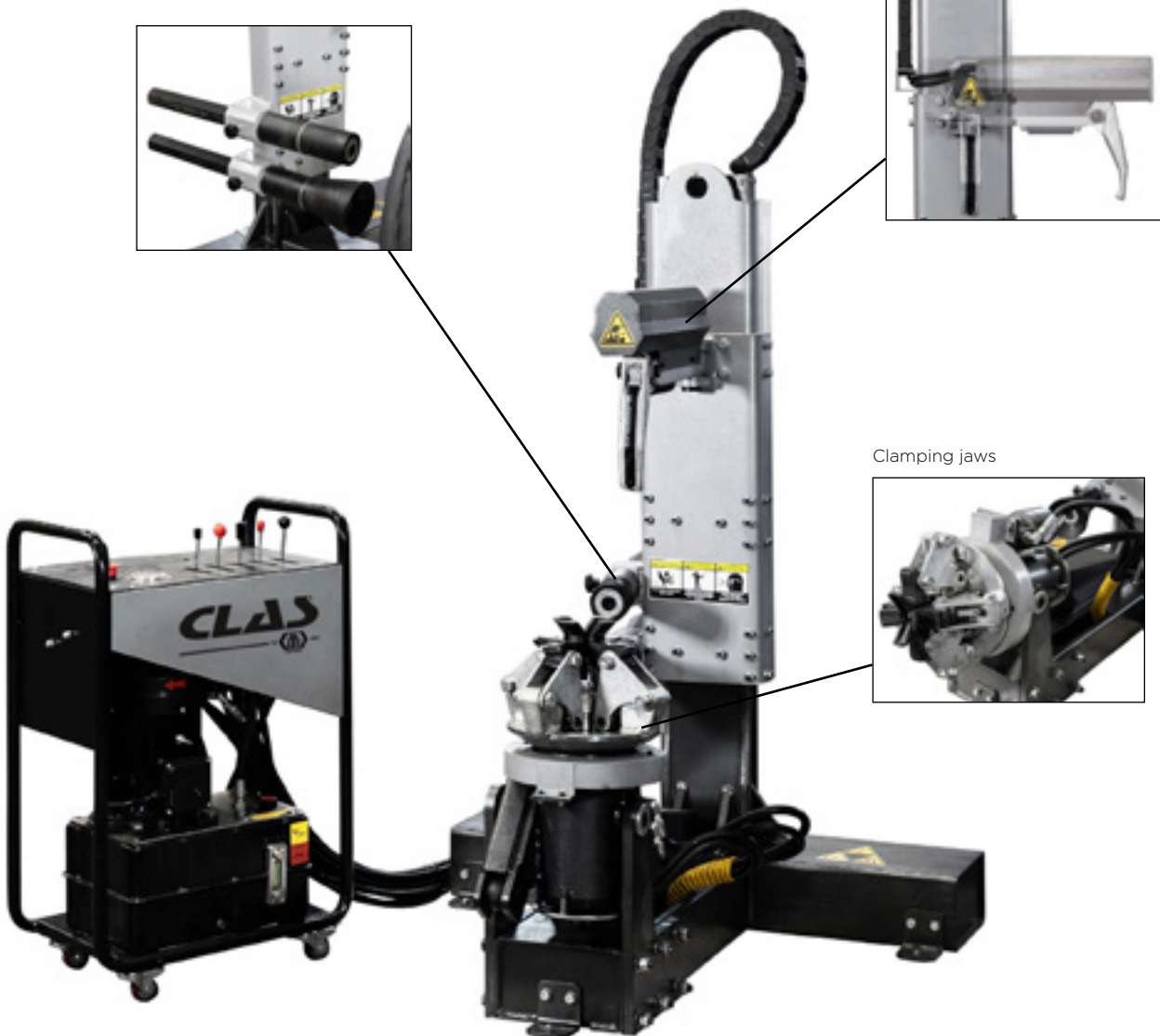

Compact dimensions

Specifications:

- maximum wheel weight: 380kg
- max wheel Ø: 1400mm
- mounting speeds: 1
- chuck speed: 8 rpm
- operating pressure: 140 bar
- electrical drive voltage: 3/400V/50Hz
- clamping range: 120 - 425mm
- maximum wheel width: 470mm
- product weight: 560kg
- rim Ø: 19 -26" Ø
- machine dimensions (WxDxH): 1630x1150x1270mm



400V 2 WARRANTY

DM 1000

AUTOMATIC TIRE CHANGER 10"-24" ONE-SPEED

Automatic tire changer designed for an effortless mounting and removal of tires. Suitable for cars, commercial vehicles and 4x4 tires.



Eurodainu



Roller-supported horizontal arm assisting the translation



Turntable with antipinch device



Protection by clip for faster replacement



Air cleaner and oil lubricator



Long lasting metallic foot controller

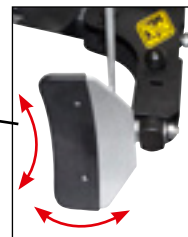

Adjustable bead breaker blade with protection and double acting cylinder

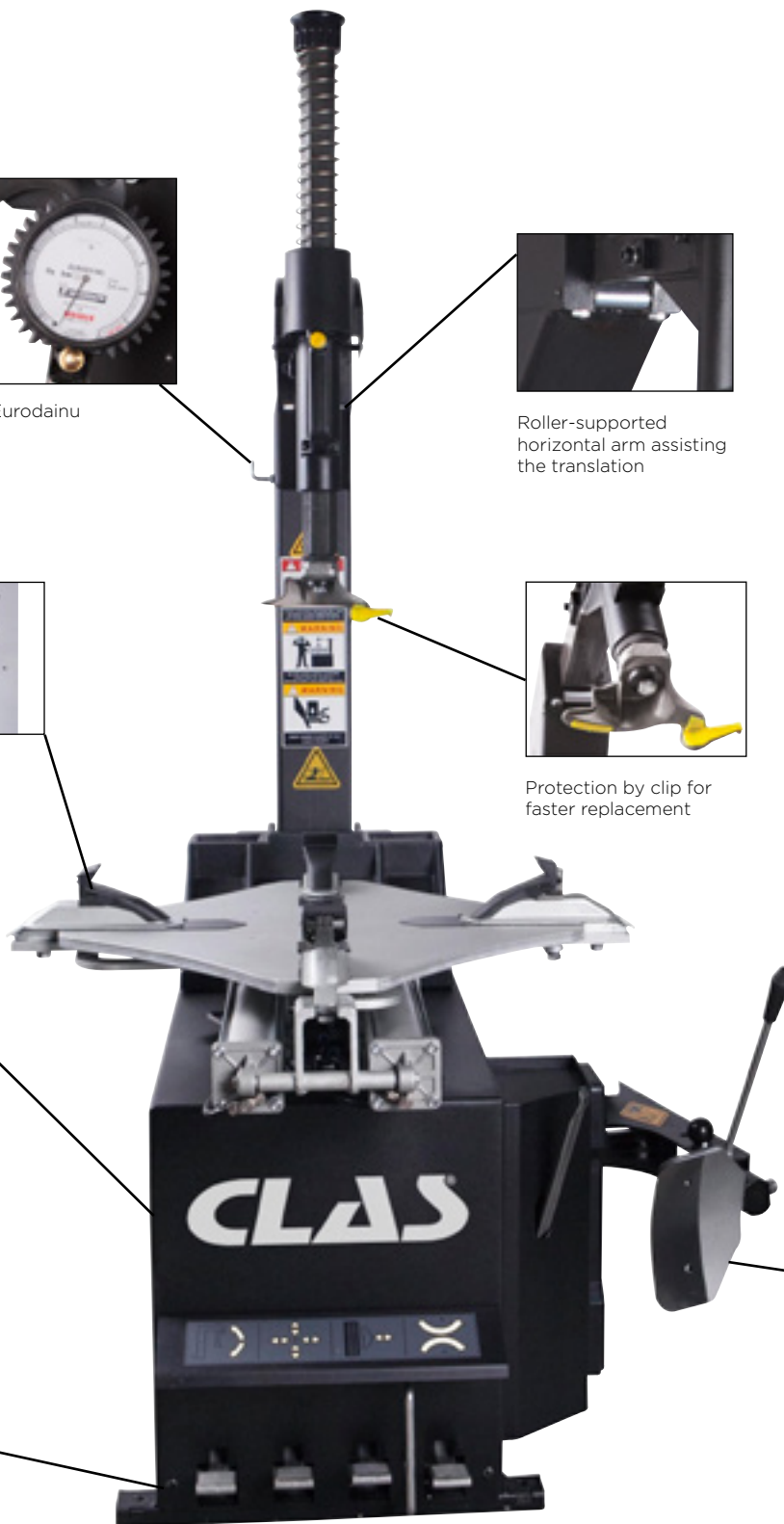



OP 0049

Supplied with:

- OP0049: Eurodainu pressure gauge (complies with 86/217/EEC. Standard UNIEN 12645)
- SA8902: 5 protection covers
- SA8903: 5 steel head protection clips
- SA8904: 1 blade protection cover
- SA8906: set of 4 alu jaw covers
- 1 lever with protection for alu rims
- DM1306: 1 elbow brush for mounting cream
- DM1310: 1 translucent tire mounting cream 1kg



SA 8902



SA 8906

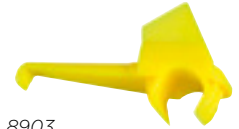

SA 8903



SA 8904



DM 1310



DM 1306

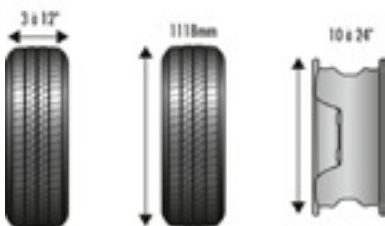
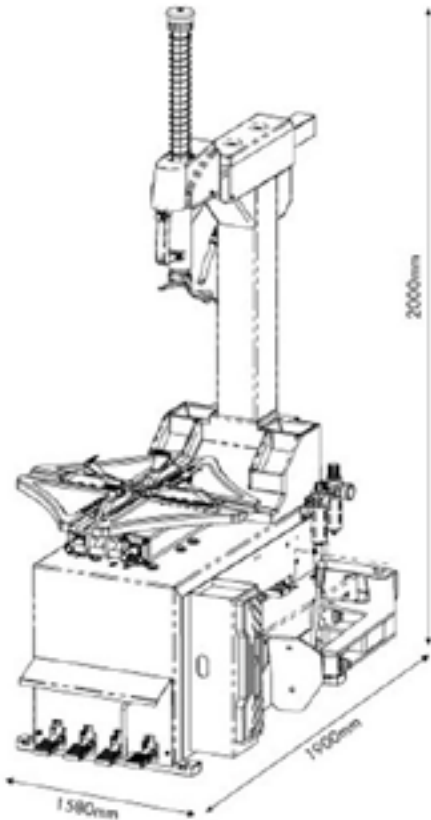

Specifications:

- roller-supported horizontal arm
- max. wheel diameter: 1180mm
- tire width: 3"-12"
- turntable with anti-pinch device
- outside clamp diameter: 10"-21"
- inside clamp diameter: 12"-24"
- turntable rotation speed: 6.5rpm
- ergonomic foot pedal
- adjustable 2 positions bead breaker blade with protection and double acting cylinder jack
- working air pressure: 8-10bar
- air cleaner and oil lubricator
- tubeless inflator safety valve: 3.5bar
- sound level < 70 dB
- power supply voltage: 400V-50Hz
- power: 0,85-1.1kW
- bead breaker arm power: 2500kg
- weight: 248kg
- dimensions: 1900x1580x2000mm

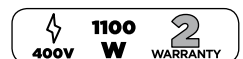

OP 0046BL

INFLATING GUN 0-12bar



B.LINE



Scale of 0 to 12 bar
Flexible length: 50mm



OP 0049

INFLATOR GUN 0.7-12bar



- for passenger cars and vans.
- complies with directive 86/217/EEC
- standard UNI EN 12645
- graduations of 0.7 to 12bar



DM 1101

PRESS ASSIST DEVICE FOR LOW PROFILE OR RUN FLAT TIRES

Accessory of DM 1000/DM 1500/DM 2000/DM 1020/DM 1520



Easy positioning of the second tire bead.



OP 0679

12L ALUMINUM AIR BLASTER/BAZOOKA



Weight : 4.05kg

Allows the tire bead to be placed on the wheel rim.

Specifications:

- aluminium tank 12L
- PU barrel, does not damage rims
- barrel width: 80mm
- 45° ergonomic handle
- pressure gauge 0-15bar
- 7.5bar safety valve
- operating pressure : 7.5bar

Supplied with PU barrel and metal barrel



DM 0106

HGV BEAD KEEPER FOR ALUMINUM WHEEL RIM

Allows the tire bead to be blocked in the wheel rim during fitting. The tool is made from coated steel and doesn't damage the wheel rim or the tire.



DM 0200

ROLL PLATFORM FOR BEAD BREAKER

Accessory of DM 2000/DM 1000/DM 1500/DM 0500BL/DM 0550BL/DM 1050/DM 1020/DM 1250/DM 1520

Workshop ergonomics increased



Easy wheel rotation while using the bead breaker. Attach to the ground at the same level as the detaching shovel.



OP 0659

19I TIRE BEAD BLASTER CAR/LCV/HGV



OP 1465

TIRE RELEASER



- Can be used on the vehicle
- Saves time
- Air regulator
- Handle exhaust
- Agricultural use

Specifications:

- travel: 80mm
- jaw opening: 68mm
- length: 380mm
- connection: 1/4"
- supply pressure: 6.2bar
- consumption: 113l/min

Connector supplied

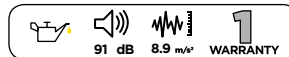

DM 1204

HYDROPNEUMATIC BEAD BREAKER + PUMP/HOSE/CONNECTOR



Bead breaker specifications:

- adapts to 17,5" to 60" wheels
- max. opening.: 130mm
- air inlet, female threading 3/8"

Pump specifications:

- 700bar
- aluminum body
- load limiter
- silent exhaust
- dimensions: L.255xW.135xH.185mm

Contents:

- DM0204: HGV/agricultural vehicles hydropneumatic bead breaker
- OH0014: hydraulic air pump 10T 1/4" (700bar)
- SA0802: hose 1/4"
- SA0803: hydraulic female adaptor
- SA4197 : adapter 3/8" D.-1/4" D.



OM 0255

TIRE REMOVER SHEATHED L.495mm

Spare part of DM 2000/DM 1000/DM 1500/DM 0500BL/DM 1020/DM 1520

Allows to tires to be removed without causing damage to rims. The removable plastic base (6mm thick) is held by 4 screws on the steel part.

Plastic coating on the rear side : anti-scratch!



SA 0355 PROTECTIVE SHEATH



DM 1304

LEVER L.530mm FOR SMALL TUBELESS TRUCK TIRES



OM 0259

TIRE REMOVER L.650mm

Accessory of DM 2000/DM 1000/DM 1500/DM 0500BL/DM 1020/DM 1520



DM 1105

UNIVERSAL DEVICE TABLE REDUCER 5"-23"

Accessory of DM 1000/DM 1500/DM 2000/DM 1050/DM 0500BL/DM 0550BL



Several positions for the jaws to suit many different wheel rims. Suitable for many wheels: from scooter and motorbike wheels with or without brake disc & belt drive, kart wheels, convex or alloy wheel rims.

Specifications:

- jaws stroke: 355-558mm
- rim diameter : 5"-23"

Not compatible with installation tables with staggered jaws.



OM 7008

2-IN-1 REVERSIBLE VALVE/VALVE CORE REMOVAL TOOL



- Easy-grip resin handle
- Valve core removal tool
- Valve puller



OM 1316

SILENT VALVE CORE REMOVER

Considerably reduces the risk of hearing damage
Clips onto the valve: one-handed valve core removal
Protects the operator against projections from the valve core or from particles present in the tire Restraint system



DM 1308

VALVE CUTTING PLIERS

Allows quick, neat and precise cuts to be made to the valves, thus facilitating their extraction.45° head perfectly matching the tilt of the valve for improved user comfort.



Specifications:

- Max. opening: 30mm
- Width of the cut: 18mm
- Length: 230mm



SA 0115

PLASTIC CHISEL

Spare part of OC 0112



CO 0500

90 CLEANSING WORKSHOP WIPES



Specially designed to clean the hands without rinsing, wiping or residues; the wipes also allow you to clean mechanical parts, tools, workbenches, bodywork, alloy wheels, instrument panels..etc

Specifications:

- double-sided: Smooth-rough
- plant-based solvents with high detergent qualities
- paraben-free
- packed in a bucket with carry grip handle



DM 1303

TRANSLUCENT TIRE MOUNTING CREAM 5kg

Does not freeze, does not dry in the pot

DM 1310

TRANSLUCENT TIRE MOUNTING CREAM 1kg



Ensures fast & precise centering of the tire on the rim thanks to its superior lubricating power
 Easy and precise application with brush
 Keeps its lubricating power even if the pot stays open
 Fast drying avoiding any rotation on rim
 Invisible, leaves no traces on the tire or the rim
 Limits corrosion formation and tire sticking on the rim

Following the 67/548/CEE and 1999/45/CE directives, this translucent mounting cream is not classified as a dangerous product and does not contain substances presenting danger.

- Specifications:**
- non-irritating (chemically neutral)
 - hardly flammable
 - does not damage rubber
 - does not damage paints
 - suitable for any tire type



DM 1306

Ø30mm ELBOW BRUSH FOR MOUNTING CREAM

Increased precision



- Specifications:**
- length: 270mm
 - tough plant-based bristle
 - wooden handle

Allows a more precise application while using the bead breaker.



DM 1307

Ø32mm STRAIGHT BRUSH FOR TIRE MOUNTING CREAM

Ultra resistant bristle



- Specifications:**
- length: 285mm
 - natural bristle, medium hardness
 - reinforced crimp ring
 - wooden handle



DM 1309

PACK BRUSHES+TRANSLUCENT TIRE MOUNTING CREAM 1kg



- Contents:**
- DM1306: Ø30mm elbow brush
 - DM1307: Ø32mm straight brush
 - DM1310: translucent tire mounting cream 1kg



CO 1037

TIRE MOUNTING GREASE SPRAY 400ml

In an aeroso : does not dry once it is opened
 1 spray = ~100 tires



Grease which can be pulverized allowing easy dosing and precise application on the tire.
 Ensures that the tire can be rapidly and precisely centered on the wheel rim thanks to its lubricating power
 Quick-drying to avoid rotation on the wheel rim
 Invisible and does not leave traces on the tire or the wheel rim
 Limits corrosion and the tire sticking onto the wheel rim



WHEEL BALANCER

721603

HGV WHEEL BALANCER W142

HGV, bus, LCV, LV

Semi-automatic measurement: automatic measurement of offset and rim Ø, manual measurement of rim width (2D function)

Flexibility of use: front panel with ergonomic controls and numerous storage compartments

Clear display: unbalance and mass indication by LED display and laser sight (LPS)

Balancing accuracy: measurement accuracy thanks to the powerful microprocessor

Wide range of programs: automatic start and stop with pneumatic brake, 11 different programs (static/dynamic, program for aluminium rims of HGV and LV) and optimization of weight distribution and hidden masses

Working comfort: electric drive, with pneumatic wheel lift, optimal mass positioning thanks to laser sight (LSP), pneumatic locking brake

Maximum safety: protective housing with automatic start & stop function

Supplied with: wheel lift, conical centering sleeves 45 to 290mm, external measuring arm, quick nut for LV, nut for HGV, calibration weights of 100 and 200 g, clamp, clamping ring for aluminium rim, mounting spring

Particularly suitable for HGV, bus, LCV and light vehicle wheels

Optional: 3/4/5 point centering plate for HGV specific wheels (ref: RSF0009)



Accessories: visit
our website

LV + LCV + Bus + HGV

NEW



Specifications:

- display (LED, LCD, TFT): LED
- measurement tolerance: +/- 1.0 g (VL)/+/- 10.0 g (VUL)
- Ø of the central hole of the rim: 45 - 290mm
- Shaft Ø: 40mm
- wheel Ø/width input: automatic
- maximum wheel weight: 160kg
- power supply: 3/400 V/50 Hz
- wheel spacing input: automatic
- rim width: 5 - 20"
- max wheel Ø: 1200mm
- rim Ø: 12 - 24" rim
- electrical drive voltage: 400 V AC/50 Hz
- weight: 350kg
- machine dimensions (WxDxH): 1800x900x1180mm



721602**MOBILE HGV WHEEL BALANCER W102**

HGV, Bus, LCV and LV

Intuitive operation: manual operation with hand brake and 5 balancing programs (static/dynamic/aluminum PL and VL programs)

Space-saving: compact dimensions and variable choice of workplace

Working comfort: no wheel lift required: height (up and down) of the machine adjustable by crank

Balancing accuracy: measurement accuracy thanks to the powerful microprocessor

Clear display: unbalance and mass indication by LED display

Ergonomic design: clear front panel with large storage space and many compartments

Supplied with: set of cones (45 - 225mm and 270 - 287mm), quick nut, ground clamp, gauge (HGV), calibration mass.

Mobile

NEW**Specifications:**

- display (LED, LCD, TFT): LED
- measurement tolerance: +/- 1.0 g (VL)/+/- 10.0 g (PL)
- Ø of the central hole of the rim: 45 - 225mm/270 - 287mm
- Shaft Ø: 40mm
- wheel Ø/width input: manually
- maximum wheel weight: 200kg
- power supply: 230 V/50 Hz
- wheel spacing input: manually
- rim width: 4 - 15"
- max wheel Ø: 1200mm
- rim Ø: 12 - 24"
- electrical voltage of l'entraînement: 400 V AC/50 Hz
- weight: 185kg
- machine dimensions (WxDxH): 1150x960x1070mm

Accessories: visit
our website**2**
WARRANTY

EQ 1000

MOTORIZED WHEEL BALANCER WITH DIGITAL DISPLAY

Motorized wheel balancer equipped with a large digital display and manual measurement of 3 parameters for precise, simple and rapid work on wheels for LV, LCVs and 4x4s.

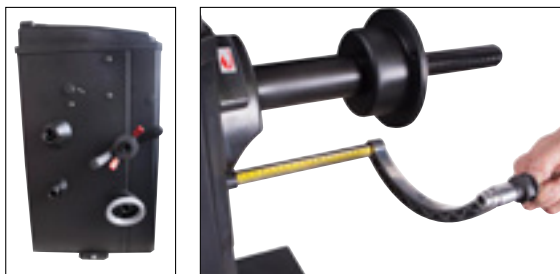

250mm

210mm

To facilitate assembly of bead rims with big backwardation

Long threaded pin for easier assembly of all types of accessories

Supplied with:

- EQ6521BL: 4 counterweights from 42 to 137mm Ø40mm
- 12mm hex wrench
- SA8305: rim width caliper

- SA8905: calibration weight 50g
- OC8034: tire pliers
- EQ6404BL: fast nut Ø40x4mm with bowl/joint/compression ring



EQ 6521BL



SA 8905



OC 8034



SA 8305



EQ 6404BL

Functions:

- european software
- automatic cycle
- multipurpose keys
- static and dynamic program (dual plane) in a single measuring run
- 9 modes: 7 Alu (hidden weight)+Optimization+Motorcycle balancing
- automatic reset/Machine calibration: 50g weights
- auto diagnostic with error codes
- multiple operator function
- simultaneous display of weights and weight positions
- measuring precision: ±1g
- display precision: 1g/5g

Specifications:

- power supply voltage: 220V-50Hz
- dimensions (wheel guard opened): 1550x1160x1490mm
- sound level < 69dB
- digital display (automatic standby mode if the machine is not being in use after 5min)
- max. wheel diameter: 1100mm
- max. wheel weight: 70kg
- rim diameter: 1-28"
- rim width: 1.5-20"
- wheel 3 parameters manual measurement
- automatic wheel guard
- one balance time: 7s
- rotating speed: 140rpm
- shaft: L.210mm-Ø40mmx4mm
- ergonomic and functional weight holder top with large trays for different types of counterweights and tools.
- 4 storage media
- support of positioning weight
- weight: 149kg

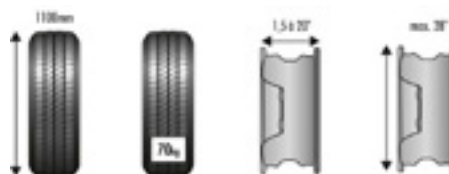
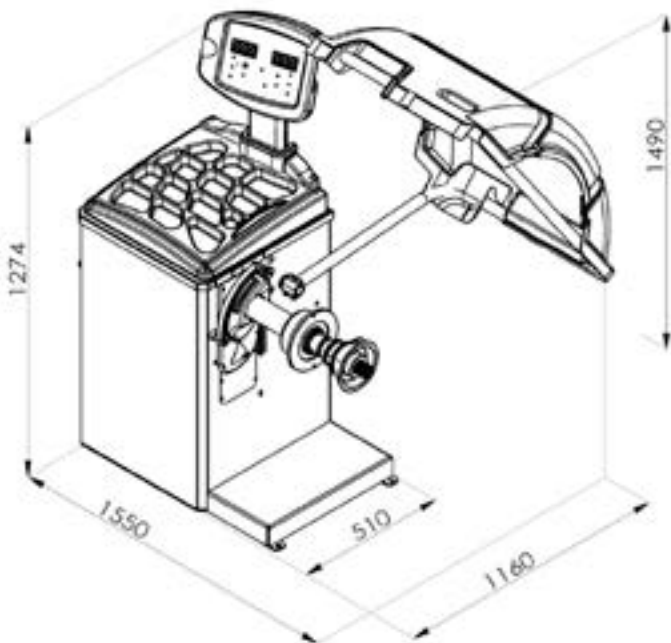

SA 8404 QUICK NUT INTENSIVE USE Ø40x4mm Spare part of EQ 1000/EQ 2000/EQ 3000/EQ 1050/EQ 8404/EQ 2100/EQ 3100

SA 6474BL BOWL/SEAL/RING KIT FOR BALANCERS Spare part of EQ 1000/EQ 1050/EQ 2000/EQ 3000/EQ 2100/EQ 3100

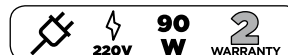

EQ 8421

3 CENTERING CONE SET INTENSIVE USE Ø40-98mm Ø40mm



Contents:

- SA8408: centering cone Ø40-62mm Ø40mm
- SA8409: centering cone Ø54-81mm Ø40mm
- SA8410: centering cone Ø70-98mm Ø40mm



EQ 8093

LCV CENTERING CONE Ø118-174mm+SPACER DISK Ø40mm KIT

Accessory of EQ 1000/EQ 2000/EQ 1050/EQ 2100



Contents:

- SA7850: LCV centering cone for intensive use Ø118-174mm
- SA7861: spacer disk Ø40mm



SA 8305

RIM WIDTH CALIPER



OC 8034

MULTIFUNCTIONAL TIRE PLIERS



SA 8404

QUICK NUT INTENSIVE USE Ø40x4mm

Spare part of EQ 1000/EQ 2000/EQ 3000/
EQ 1050/EQ 8404/EQ 2100/EQ 3100



SA 8466

5 CENTERING RINGS

Accessory of EQ 8400

- SA8455: ring Ø55mm
- SA8457: ring Ø57mm
- SA8458: ring Ø58mm
- SA8460: ring Ø60mm
- SA8465: ring Ø65mm

SA 8366

5 CENTERING RINGS

Accessory of EQ 8280/EQ 8380/EQ 8360/EQ 8440

- SA8355: ring Ø55mm
- SA8357: ring Ø57mm
- SA8358: ring Ø58mm
- SA8360: ring Ø60mm
- SA8365: ring Ø65mm



For intensive use

EQ 9400

UNIVERSAL CYLINDRICAL QUICK FLANGE Ø40mm WITH 5 CENTERING RINGS

Contents:

- EQ8400: universal cylindric quick flange Ø40mm for EQ1000/EQ2000/EQ3000
- SA8455: ring Ø55mm
- SA8457: ring Ø57mm
- SA8458: ring Ø58mm
- SA8460: ring Ø60mm
- SA8465: ring Ø65mm
- SA6400: Universal gauge measuring wheel interaxis 52-150mm



OE 2060

1/2" RECHARGEABLE IMPACT WRENCH 600Nm

Spare part of OE 2065

Specifications:

- maximum torque: 600Nm
- speed: 0-1600rpm
- impacts per minute: 0-3200bpm
- battery: Li-ion 18V 4.0Ah
- charger with charge-level indicator
- length: 235mm

Supplied in a composite case with a charger and 1 battery (SA2605)

17.9 m/s² 18V 1 WARRANTY



NEW

Only 120mm long

OP 1513

1/2" D. COMPACT IMPACT WRENCH 1084Nm DOUBLE HAMMER

Specifications:

- maximum torque: 1084Nm
- speed of rotation: 9,000 rpm
- connection: 1/4"
- Ø recommended hose Ø: 10mm
- supply pressure: 6.2bar
- consumption: 170l/min
- net weight: 1.2kg

Impact wrenches see p.78

89.9 dB 6.8 m/s² 1 WARRANTY



OP 1405

3/4" D. IMPACT WRENCH 1898Nm

Specifications:

- max. torque: 1898Nm
- release torque: 1627Nm
- speed: 5,500rpm
- length: 215mm
- connection: 3/8"
- supply pressure: 6.2bar
- consumption: 198l/min
- net weight: 3.3kg

90 dB 10.2 m/s² 1 WARRANTY



OP 1407

1" D. IMPACT WRENCH 2441Nm

Specifications:

- max. torque: 2441Nm
- release torque: 2033Nm
- speed: 6,000rpm
- length: 467mm
- connection: 1/2"
- supply pressure: 6.2bar
- consumption: 282l/min
- net weight: 7.5kg

86 dB 6.5 m/s² 1 WARRANTY





LIFTING RAMPS

2-POST LIFT



NEW

622216.10N

**2 COLUMNS ASYMETRIC POST LIFT 5T
COMFORT LIFT 2.50**

High-quality and rugged electro-hydraulic 2-post lift
Two control panels for flexible use on both columns
"Energy-Set" at main control panel (consisting of 230V plug / 12V plug / compressed air jack)
Fast lifting and lowering with high hydraulic power unit
Very low drive over plate (height = 20mm) for comfortable working in the workshop and to protect hydraulic hoses and synchronization ropes
Multifunctional operating range by telescopic lifting arms, optionally asymmetric (short - long) or symmetric (long - long) version
Double-telescopic lifting plates (90 - 180mm) with twist protection
Automatically unlocking of lifting arm blocking
Electromagnetic safety locking system
Band-cover for protection of cylinders, chains and ropes inclusive
Short or long lifting arms also optionally available as an accessory
FREE-LINE system: Modularity and flexibility in the lift composition according to needs thanks to optional interchangeable elements

Max. T **5** **400V** **1** WARRANTY

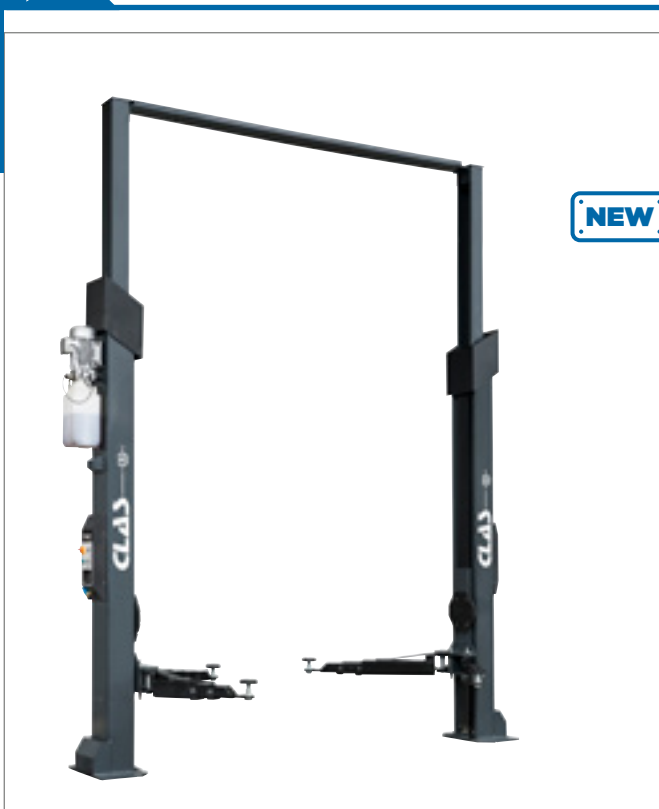

NEW

622218.10

**2 COLUMNS ASYMETRIC POST LIFT 5T
COMFORT LIFT 2.50X**

High-quality and rugged electro-hydraulic 2-post lift
Two control panels for flexible use on both columns
"Energy-Set" at main control panel (consisting of 230V plug / 12V plug / compressed air jack)
Fast lifting and lowering with high hydraulic power unit
Very low drive over plate (height = 20mm) for comfortable working in the workshop and to protect hydraulic hoses and synchronization ropes
Multifunctional operating range by telescopic lifting arms, optionally asymmetric (short - long) or symmetric (long - long) version
Double-telescopic lifting plates (90 - 180mm) with twist protection
Automatically unlocking of lifting arm blocking
Electromagnetic safety locking system
Band-cover for protection of cylinders, chains and ropes inclusive
Short or long lifting arms also optionally available as an accessory
FREE-LINE system: Modularity and flexibility in the lift composition according to needs thanks to optional interchangeable elements

Max. T **5** **400V** **1** WARRANTY

MOBILE COLUMN LIFT

Mobile columns with mechanical drive

Maximum flexibility: 4 columns, long cable lengths for optimal positioning

Easy to move: hydraulic mobility kit integrated on each column for greater speed and safety

Comfort of use: push button control panel on each column

High variability: switchable column control for individual, device or general lifting

Precise ascent and descent: lifting and descent mechanism by trapezoidal threaded rod, self-locking bronze nut, thermally protected motor

Maximum safety: safety nut in case of failure of the bearing nut

Particularly suitable for PL and Bus

Option: adapters for small trucks (ref: 710020)

Option: mobile candles (ref: 710050)

NEW



710015

4 MOBILE HGV LIFT COLUMNS 5.5T
RG5.5-4 WIRE CONNECTION

Specifications:

- lifting height max.: 1760mm
- lifting time loaded: 180 s
- lowering time loaded: 180 s
- fuse protection: 3C32 A
- power supply: 3/400V/50Hz
- product weight: 2790kg
- capacity per column: 5500kg

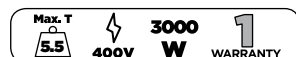

710017

4 MOBILE HGV LIFT COLUMNS 7.5T
RG5.5-4 WIRE CONNECTION

Specifications:

- lifting height max.: 1760mm
- lifting time loaded: 180 s
- lowering time loaded: 180 s
- fuse protection: 3C32 A
- power supply: 3/400V/50Hz
- product weight: 3180kg
- capacity per column: 7500kg



Mobile columns with mechanical drive
 Maximum flexibility: 6 columns, long cable lengths for optimal positioning
 Easy to move: hydraulic mobility kit integrated on each column for greater speed and safety
 Comfort of use: push button control panel on each column
 High variability: switchable column control for individual, device or general lifting
 Precise ascent and descent: lifting and descent mechanism by trapezoidal threaded rod, self-locking bronze nut, thermally protected motor
 Maximum safety: safety nut in case of failure of the bearing nut
 Particularly suitable for PL and Bus
 Option: adapters for small trucks (ref: 710020)
 Option: mobile candles (ref: 710050)



NEW

710016

**6 MOBILE HGV LIFT COLUMNS 5.5T
 RG5.5-6 WIRE CONNECTION**

Specifications:

- lifting height max.: 1760mm
- lifting time loaded: 180 s
- lowering time loaded: 180 s
- fuse protection: 3C32 A
- power supply: 3/400V/50Hz
- product weight: 4185kg
- capacity per column: 5500kg

Max. T **5.5** 400V **3000 W** **1** WARRANTY

710018

**6 MOBILE HGV LIFT COLUMNS 7.5T
 RG7.5-6 WIRE CONNECTION**

Specifications:

- lifting height max.: 1760mm
- lifting time loaded: 180 s
- lowering time loaded: 180 s
- fuse protection: 3C32 A
- power supply: 3/400V/50Hz
- product weight: 4770kg
- capacity per column: 7500kg

Max. T **7.5** 400V **3000 W** **1** WARRANTY



NEW

710050 HGV JACK STAND 7.5-1800

Accessory of 710015/710016/710017/710018



BODY REPAIR SOLUTIONS



321

TROLLEYS & STORAGE



325

WELDING

- 325 - PLIERS
- 326 - CUTTING
- 327 - WELDER



329

SCOURING

- 329 - GRINDER
- 332 - BLASTING
- 333 - SCOURING AGENT



335

PAINTING

- 335 - PREPARATION & TREATMENT
- 339 - GUNS
- 340 - DRYING



341

STRAIGHTENING

- 341 - HAMMERING TOOLS
- 342 - RAMS



344

PAINTLESS DENT REMOVAL



347

DOORS & CABIN

- 347- HABITACLE
- 348 - DOORS OPENING
- 349 - STAPLES



350

CLEANING

- 350 - VACUUMS
- 351 - CLEANING AGENT
- 352 - SPRAYERS



355

GLAZING

- 355 - CUTTING
- 365 - HANDLING



367

HEADLIGHT

- 367 - HEADLIGHT ADJUSTMENT
- 370 - REPAIR/REBUILDING



371

PLASTIC

- 371 - REPAIR/REBUILDING



375

DRILLING



TROLLEYS & STORAGE

OH 9150

HYDROPNEUMATIC MOBILE LIFTING
COLUMN 1500kg



Specifications:

- 2 swivel wheels to facilitate handling
- safety pin: 5 secure heights
- lifting by the wheel or the car body



SA9151: Lifting under the wheel
Max. working height: 735mm
Min. height: 100mm
Wheel diameter from 480 to 730mm

SA9152: Lifting under the car body
Max. working height: 835mm
Min. height: 140mm

Supplied with hydraulic air pump 10T



OM 2024

VEHICLE DOLLY CASTER SYSTEM 1360kg (PAIR)

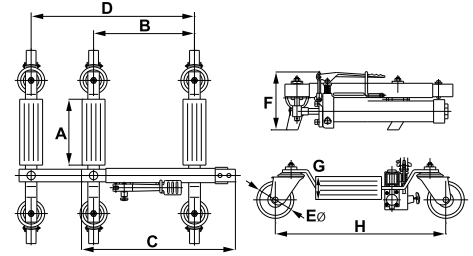

Specifications:

- lifting assisted by hydraulic ram
- aluminum roller L.300mm
- 4 casters, 2 with lock
- capacity : 2720kg (4 jacks)

		Dimensions (mm)							
		A	B	C	D	EØ	F	G	H
OM 2024		305	345	540	625	100	190	68	560



SA 2071	PAIR OF PIVOTING WHEELS Ø100x30mm	Spare part of OM 2024/OM 2018/OM 2021
SA 2072	PAIR OF PIVOTING BRAKED WHEELS Ø100x30mm	Spare part of OM 2024
SA 2074	PAIR OF ALUMINUM ROLLERS	Spare part of OM 2024/OM 2018/OM 2021

OC 1200

TROLLEY BLOCKED UNDER CAR BODY

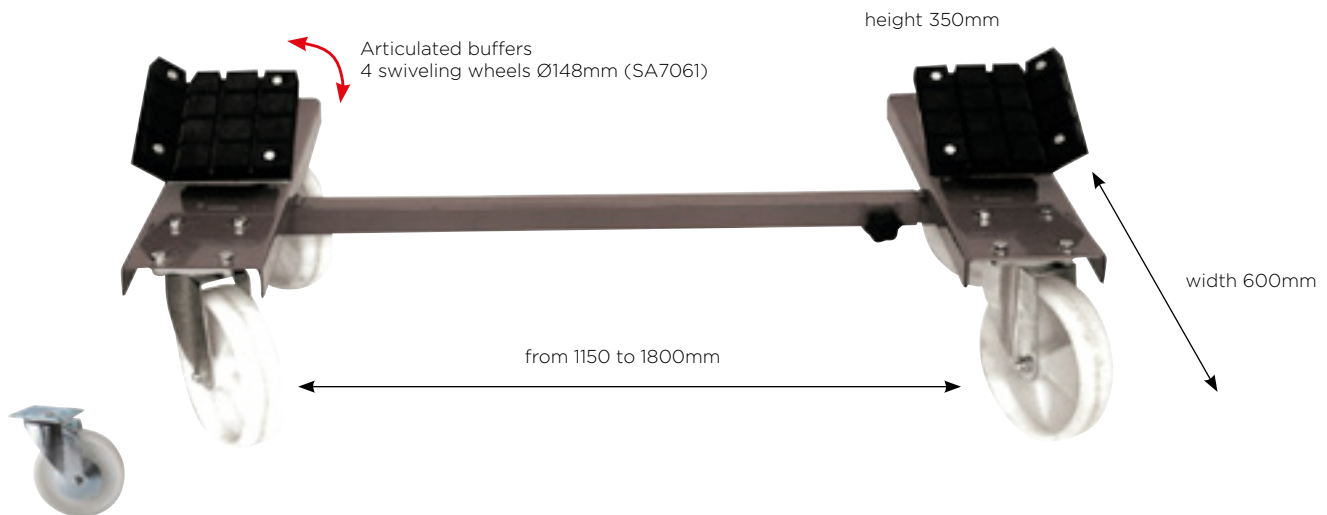

SA 7061	PIVOTING DOLLY WHEEL Ø148mm	Spare part of OC 1200/OC 1101/OC 1102
---------	-----------------------------	---------------------------------------



EG 0108

MULTIFUNCTIONAL FOLDING WORKSHOP TROLLEY 150kg

Allows large and heavy objects to be moved effortlessly.



Folding backrest for convenient storage



Specifications:

- capacity: 150kg
- non-slip covering
- rubber shock-proof edges
- 4 Ø120mm wheels, 2 of which swivel for improved handling
- dimensions: L.870xW.575xH.900mm
- folded height: 290mm
- platform height: 195mm



OC 0711

BODYWORK 3 TRAY STORAGE TROLLEY

Allows parts which have been uninstalled to be put away and stored such as headlights, headrests, instrument panels, bumpers...etc



Specifications:

- 3 trays (2 wooden and 1 mesh)
- platform height: 260-810-1390mm
- mesh base
- 4 swiveling wheels, 2 of which have brakes
- dimensions: L.630xW.1110xH.1625mm



OC 6041

PARTS/WINDSCREEN/COVERS DOLLY

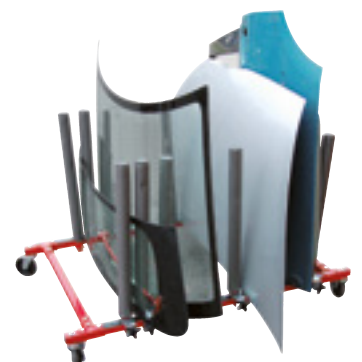

Specifications:

- independent, sliding, foam covered support bars
- height of support bars: 590mm
- 5 modifiable compartments to hold the parts in total safety
- 2 of the wheels have brakes
- Ø wheels: 90mm



OC 0717

BODYWORK SUPPORT

Completely adjustable to accommodate a wide range of parts such as doors, bonnets, wings...



Max. Kg **140**
2 WARRANTY

OC 0780

RIM STAND



Specifications:

- suitable for 4 rims with tires
- adjustable height: 870-1050mm
- adjustable sliding handle stroke: 670mm
- equipped with 4 swiveling wheels and 2 swiveling braked wheels

2 WARRANTY

OC 0716

UNIVERSAL TELESCOPIC BODYWORK HOLDER 23-138cm



Does not scratch
paintwork

Specifications:

- width: 22.5 à 138cm
- height: 84 à 132cm
- anti-slip rubber-sheathed support arm
- support arm length: 86cm
- support arm width: 8cm
- capacity: 100kg
- 4 swiveling wheels, 2 of which have brakes

Max. Kg **100**
2 WARRANTY

WELDING

PLIERS

OM 8069

16 PACK LOCK GRIP PLIERS



Contents:

- OM8082 (x3): lock grip pliers 285mm
- OM8080 (x5): lock grip pliers 225mm
- OM8083 (x3): lock grip pliers 240mm
- OM8081 (x5): lock grip pliers 190mm



NO WARRANTY

OM 8080

LOCK GRIP PLIER
225mm

Spare part of OM 8069



OM 8082

LOCK GRIP PLIER
285mm

Spare part of OM 8069



Removable jaws

OM 8081

LOCK GRIP PLIER
190mm

Spare part of OM 8069



OM 8083

LOCK GRIP PLIER
240mm

Spare part of OM 8069



For U and angles

NO WARRANTY



CUTTING

OC 0221

CONNECTABLE PLASMA CUTTER 40A



Specifications:

- cuts all electrically conductive metals: steel, stainless steel, aluminium, bronze, brass
- max cutting thickness steel: 8mm
- low current absorption
- soft and stable cutting arc
- safety and protection:
 - Overvoltage
 - Overheating with LED indicator
 - Air pressure
- L.3m torch with safety system
- supply voltage: Volt 50-60Hz (AC)-1Phx230V
- clamp 200A 16mm² L.3m
- installation power: 6kW
- cutting current: 10 to 40 amperes
- operating factor: 40A to 60% - 30A to 100%
- pressure regulator 0-10bar
- recommended pressure: 4 to 6bar
- dimensions: 380x290x230mm

SA 0231	CENTRAL PLASMA CUTTING UNIT
SA 0232	PLASMA CUTTER TORCH
SA 0233	BAG OF 10 ELECTRODES
SA 0235	BAG OF 2 DIFFUSERS
SA 0236	BAG OF 3 NOZZLES
SA 0237	NOZZLE HOLDER

6000 W 5 m 220V 1 WARRANTY

OE 1224

OVERLOAD CIRCUIT BREAKER 12-24V

This device protects the vehicle electronically from overload.

Protect the electronics and avoids reprogramming clock/radio...



Connect the two alligator clips to the battery. If the LED lights up, the device is connected correctly and is ready to use.

Visual and sound signal
Connects directly to the battery terminals, no mounting direction

- Max. clamping voltage 12V:
- 32.5V/308A (8-20µs)
 - 25.2V/59.5A (10-1000µs)
- Max. clamping voltage 24V:
- 59.0V/169A (8-20µs)
 - 45.7V/33A (10-1000µs)

12-24V 1 WARRANTY

WELDER

EG 0056

WIRE BRUSH

Handy steel wire metallic brush ideal for a multitude of uses.

- carbon steel wire
- soft grip handle



CO 1046

MASTIC BAR TO MODEL METAL REPAIR 57g

Allows repairing broken metal, sealing a radiator, recreating fixing brackets, rethreading on all types of metals...

Specifications :

- thermal resistance: 150°C
- water and hydrocarbon resistant
- drying time: 10min to the touch, 3h to the core

Wait 1 hour before drilling, tapping, sanding, painting...

Can be drilled, tapped, threaded, filed, painted...



OC 0215

SPOT WELD AND DENT PULLER

Compact and lightweight

Limits heating in the spotted area: does not damage the anti-rust layer + preserves consumables

Preserves consumables up to 10x longer than a conventional spotter

Specifications:

- power setting: 10 currents up to 5000A
- thermal protection indicator
- supply voltage: Volt 50-60Hz (AC)-1Phx230
- fuse: 10 amps
- installation power: 1kW
- cadence: 8 to 5 spot/min
- cable length: 3m
- dimensions: 356x105x170mm

Contents:

- spot repairer
- SA0239: inertia straightening hammer for spinning
- SA0240: charger for pulling rings
- SA0241: lever of pulling by point + 2 M5 round electrodes (SA0447)
- SA0245: ring/triangles/stars holder electrode
- SA0247: 50 pulling triangles
- SA0248: 50 pulling stars (5 branches)
- SA0249: 50 pulling rings

Option:

- SA0449: 50 pulling twisted rings 90°



SA 0238	CENTRAL UNIT SPOT WELD AND DENT PULLER	
SA 0239	SLIDE STRAIGHTENING HAMMER FOR SPOT REPAIRS	Accessory of OC 0215
SA 0240	CHARGER FOR SPOTER PULLING RINGS	Accessory of OC 0215
SA 0241	LEVER PULLING BY POINT + 2 M5 ROUND ELECTRODES (SA0447)	Accessory of OC 0215
SA 0245	RINGS/TRIANGLES/STARS HOLDER ELECTRODE	Spare part of OC 0215/SA 0247/SA 0248/SA 0249/SA 0448
SA 0247	50 PULLING TRIANGLES SET	Spare part of OC 0215
SA 0248	50 PULLING STARS SET (5 POINTED)	Spare part of OC 0215
SA 0249	50 PULLING RINGS SET	Spare part of OC 0215/SA 0245/SA 0240
SA 0447	M5 ROUNDED ELECTRODE	Spare part of OC 0215/SA 0241
SA 0449	PULLING TWISTED 90° RINGS SET	Spare part of OC 0215/SA 0245/SA 0240



EG 0050

**PORTABLE GAS
SOLDERING IRON**



SA0811: 100g tin
EG0047: Butane gas (not included)

Specifications:

- solder up to 500°C
- 4-position adjustment
- supplied with 4 tips
- after-use support
- piezo ignition



OE 0811

SOLDERING IRON 30W WITH STAND

This soldering iron is ideal for a multitude of works. The high quality tips are suitable for lead-free soldering.



The work stand has two crocodile clips for holding electronic boards.
Weight: 560g

Delivered with tin, tips and sponge

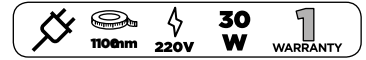

OP 1460

SPOT DRILL



- Quiet
- Low speed/high torque
- Orientable locking jaws
- Ergonomic handle
- Swiveling connector
- Bottom exhaust

Specifications:

- speed: 800tr/min
- for reamer: Ø6.3/8.3/10.3x47mm
- length: 349mm
- connection: 1/4"
- supply pressure: 6.2bar
- consumption: 113l/min



Connector supplied

SA 1460 CARBIDE REAMER 8.3x47mm

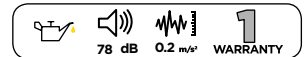

SA 1464

**OFFSET SWIVEL CLAMP WITH
LOCKING SYSTEM**

Accessory of OP1460



Offset: 140mm



EG 0047

GAS REFILL

Accessory of EG 0050/EG 0540/SA 0540/SA 0541



OC 0025

BODYWORK PLIERS

Model equipped with a swiveling head to punch (Ø5mm) and fold (12mm) sheet steels before welding.
For sheet steel 1.4mm maxi.



SCOURING GRINDER

OP 1203

MINI DIE GRINDER Ø6mm 25,000rpm



- Light
- Grip handle
- Safety throttle
- Rear exhaust with silencer

Specifications:

- speed: 25,000rpm
- length: 159mm
- connection: 1/4"
- supply pressure: 6.2bar
- consumption: 113l/min

Connector supplied



CO 1203	50 ABRASIVE DISCS P40 Ø50mm	Accessory of OP 1203/OP 1204/OP 1205/CO 1202	
CO 1204	50 ABRASIVE DISCS P60 Ø50mm	Accessory of OP 1203/OP 1204/OP 1205/CO 1202	
CO 1205	50 ABRASIVE DISCS P80 Ø50mm	Accessory of OP 1203/OP 1204/OP 1205/CO 1202	
CO 1202	ABRASIVE DISC HOLDER TRAY Ø50mm	Accessory of OP 1203/OP 1204/OP 1205/CO 1201/CO 1203/CO 1204/CO 1205	
CO 1209	150 ABRASIVE DISC SET Ø50mm	Accessory of CO 1202	Contents: • CO1203: 50 abrasive discs P40 Ø50mm • CO1204: 50 abrasive discs P60 Ø50mm • CO1205: 50 abrasive discs P80 Ø50mm
CO 1201	ABRASIVE HOLDER DISC TRAY SUPPORT AXLE Ø50mm	Accessory of OP 1421/OP 1203/OP 1204/OP 1205/CO 1202	



OP 1205

MINI ANGLE DIE GRINDER Ø6mm



- Light
- Grip handle
- Safety throttle
- Rear exhaust with silencer
- Speed regulator
- Swiveling connector

Specifications:

- speed: 20,000rpm
- angle: 115°
- vibration: 1.24m/s²
- connection: 1/4"
- supply pressure: 6.2bar
- consumption: 113l/min

Connector supplied

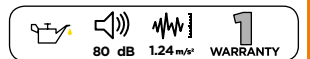

OM 0643

10mm 5 CARBIDE ROTARY RASPS BOX



Specifications:

- right cut
- diamond gearing
- 6mm cylindrical shank
- material: carbide

Contents:

- Ø10mm cylindrical rasp with straight head
- Ø10mm cylindrical rasp with spherical head
- Ø9.8mm spherical rasp
- conical rasp with pointed head
- ogive rasp



OP 1214

REVERSIBLE DISK-SANDER



- powerful
- composite housing
- reversing bar on both sides
- rear exhaust with silencer

Specifications:

- speed: 16,000rpm
- plates: 75/100/125mm
- motor: 0.60cv
- length: 142mm
- connector: 3/8"
- supply pressure: 6.2bar
- consumption: 113l/min

Connector supplied

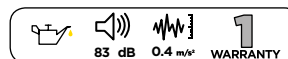

OP 1206

ANGLE GRINDER Ø125mm



- powerful
- centrifugal regulator
- Alu/composite sump
- 9 adjustable protective sump positions
- reversible auxiliary handle
- fast-change disk
- rear exhaust

Specifications:

- speed: 10,000rpm
- shank: M14
- disc: 0.8mm to 6mm
- motor: 0.75cv
- length: 238mm
- connection: 1/4"
- supply pressure: 6.2bar
- consumption: 113l/min

Connector supplied

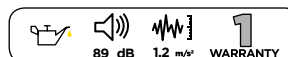

OP 1210**MULTI-SERVICE BRUSH**

SA 1209	WIRE BRUSH (FINE) L.23mm	
SA 1210	METAL BRUSH L.23mm	
SA 1211	HARD GUM Ø105mm	Accessory of OP 1210
SA 1212	SOFT GUM Ø105mm	Accessory of OP 1210



- light
- safety guard
- grip handle + auxiliary handle
- use with gum or brush
- safety throttle
- rear exhaust

Specifications:

- speed: 3,500rpm
- length: 280mm
- connection: 1/4"
- supply pressure: 6.2bar
- consumption: 110l/min

Supplied with:

- connectors
- SA1210 : metal brush Ø23mm
- SA1213 : adapter for gum and brush Ø23mm

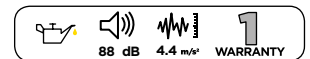
**OP 1445****10mm BELT SANDER**

- Safety throttle
- Covered grip
- Handle exhaust + silencer
- Swiveling connector
- Safety lever

**Specifications:**

- speed: 18,000rpm
- belt: 10mmx330mm
- max. length: 330mm
- length folded: 207mm
- connection: 1/4"
- supply pressure: 6.2bar
- consumption: 116l/min

Connector supplied

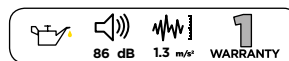
**CO 1035****NO RUST SPRAY 400ml**

Stops rust developing on bodywork and running gears.
For preventative and curative use.

**Transparent**

If the surface does not require sanding and the rust is superficial, the rust prevention spray will let you "stabilize" the rust in order to stop it from spreading. You can then have the surface painted as it is. If your surface has not yet been attacked by rust, you can use this spray as a preventative measure in order to protect it.

**OP 1470****10mm AIR BODY SAW**

- light
- composite body
- low vibration
- swiveling connector
- safety trigger
- ergonomic handle with protection

**Specifications:**

- strokes/min: 9500
- stroke length: 10mm
- length: 300mm
- connector: 1/4"
- supply pressure: 6.2bar
- consumption: 90l/min

Supplied with:

- connector
- SA1470: 24-tooth blade
- SA1471: 32-tooth blade

SA 1470	24-TOOTH BLADE
SA 1471	32-TOOTH BLADE



BLASTING

OP 0615

HIGH-FLOW SANDING GUN (ceramic nozzle)

Pneumatic sandblaster with ceramic nozzle



Specifications:

- extraction hose 3m
- service pressure: 6 to 8bar
- air consumption: 500L/min
- to be used with sand drum SA6615



SA 6616 CERAMIC NOZZLE Spare part of OP 0615



SA 6615

DRUM OF SYNTHETIC SAND 30kg

Accessory of OP 0615/OP 0617/OP 0618



Chemical composition:

- quartz: 42-58%
- corundum: 23-32%
- hematite: 3-15%
- lime: 2-8.5%
- potassium oxide: 0.5-4.6%

Synthetic sand 0.5 to 1mm grain.



OP 0617

HIGH-FLOW SANDING GUN (metal nozzle)

Specifications:

- air consumption : 750L/min
- working pressure : 8bar
- hose length : 1.2m

SA0617: Metal nozzle



SCOURING AGENT

OP 1338

CARTRIDGE SPRAY GUN (POLYMER MS)

Allows the application of sealants, seals and waterproofing adhesives sprayable with 310ml cartridges.
Spray or extrusion application.

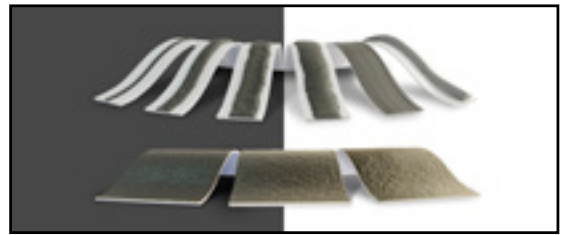

Specifications:

- adjustable pressure and flow rate
- operating pressure: 3-5bar

Supplied with spray and extrusion nozzle



CO 1034

ANTI GRAVEL MS POLYMER BLACK CARTRIDGE 310ml

Spare part of OP 1338



Easy to install, giving an optimal result. Ideal for application on bare metal.
This brand new cutting-edge product can be applied wet-on-wet to obtain an optimal anti stone-chip effect in record time.

- adheres to all surfaces
- anti-corrosive, may even be applied to bare metal
- high density: load up to 5mm in a single movement
- also permits the reproduction of seals which were originally sprayed and crimped seals



CO 1057

ANTI GRAVEL MS POLYMER BEIGE CARTRIDGE 310ml



CO 1058

ANTI GRAVEL MS POLYMER GREY CARTRIDGE 310ml

NEW



OP 1481

SANDBLASTING GUN

For projection of soundproofing products, sealants and anti-rust.



Specifications:

- nozzle Ø: 6mm
- working pressure: 8bar max.
- air consumption: 100 to 150l/min



CO 1027

EXPRESS PAINT REMOVER SPRAY 500ml

Allows paint, varnish and ink pickling on every body repair painted element.
Remove burned and imbedded seals (cylinder head, gearbox, water pump, etc)..



Active formula: quick and efficient.

It allows you to achieve excellent results with no effort required. Its active formula breaks down problems quickly. This product is suitable for use on solvent-resistant mounts.

Applications: Acrylic, Glycerol, Alkyd, Pliolite...



CO 1022

GLUE AND WHITE MASTIC CARTRIDGE 310ml

Permits adhesion of spoilers, vehicle undersides, flat crimping, application of mastic to pointed steel plates...etc Can be painted straight after application.
Adheres to steel, aluminum, stainless steel, wood, concrete, stone, gelcoat, polyester, glass, lacquers and treated paint.



Adhesion without primer on metallic surfaces

Latest generation MS polymer adhesive cartridge allows you to achieve all types of seals and adhesion with no mechanical assembly required. Easy to apply, it provides an elasticity level of 300% while guaranteeing a traction force greater than 2.7N/mm².

Specifications:

- elastomer: 300% elasticity
- touch dry: 5-10min
- solvent-free

CO 1047

GREY GLUE AND MASTIC CARTRIDGE 310ml

CO 1048

BLACK GLUE AND MASTIC CARTRIDGE 310ml



CO 1035

NO RUST SPRAY 400ml

Stops rust developing on bodywork and running gears. For preventative and curative use.



Transparent

If the surface does not require sanding and the rust is superficial, the rust prevention spray will let you "stabilize" the rust in order to stop it from spreading. You can then have the surface painted as it is. If your surface has not yet been attacked by rust, you can use this spray as a preventative measure in order to protect it.



CO 1033

ANTI STONE-CHIP SPRAY 400ml

Anti stone-chip spray which allows you to almost exactly reproduce fine and medium anti stone-chip effects. Its thick formula will offer real protection to the mount you wish to treat with quick and easy application.



Exclusive thick formula, remains supple after drying

Forms an elastic, wear-resistant protective coating. Protects against stone chips and corrosion



PAINTING

PREPARATION & TREATMENT

EG 0055

CENTRAL VACUUM CLEANER 2x1300W

Vacuum cleaner that can also be used as a central vacuum cleaner. Compatible with pneumatic and electric tools up to 1200W.



Accessories included:
 • SA0405: hose Ø28mm 4.5m
 • SA0406: filter

Option :
 • SA0409: bag 36L

Specifications:

- 76L plastic tank mounted on 4 castors trolley
- 2 motors 1300W
- tool tray 600x480mm
- hose Ø28mm 4.5m with integrated pneumatic hose
- depression 23.5kPa
- air flow rate: 119l/s
- noise level: 68dB
- dimensions: 580x590x940mm

68 dB 2600 W 220V 1 WARRANTY



OP 1311

5mm RANDOM ORBITAL PALM SANDER
Ø150mm

Specifications:

- speed: 12,000rpm
- orbit: 5mm
- pad: Ø150mm
- length: 196mm
- connector: 1/4"
- supply pressure: 6.2bar
- consumption: 57l/min
- net weight: 0.7kg



OP 1312

2.5mm RANDOM ORBITAL PALM SANDER
Ø150mm

Specifications:

- speed: 12,000rpm
- orbit: 2.5mm
- plate: Ø150mm
- length: 196mm
- connector: 1/4"
- supply pressure: 6.2bar
- consumption: 57l/min
- net weight: 0.7kg
- ultra-light composite body with anti-vibration belt
- speed regulator
- rear exhaust
- Ø32mm connection for cuff
- one-handed use

- ultra-light composite body with anti-vibration belt
- speed regulator
- rear exhaust
- connection for cuff Ø32mm
- for use by hand

Connector supplied

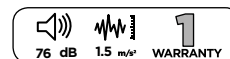

OE 1319

**ELECTRIC ORBITAL SANDER 5mm
Ø150mm**

Accessory of EG 0055

Specifications:

- ultra-light composite body with anti-vibration coating
- speed controller: 2000 to 10000 rpm
- Brushless motor
- LDS system
- connection for cuff Ø22mm
- one-handed operation
- power: 350W
- orbit: 5mm
- plate: Ø150mm
- height: 94mm
- length: 251mm
- sanding cable: 4m
- weight: 900g

NEW

OE 1318

**ELECTRIC ORBITAL SANDER 2.5mm
Ø150mm**

Accessory of EG 0055

Specifications:

- ultra-light composite body with anti-vibration coating
- speed controller: 2000 to 10000 rpm
- Brushless motor
- LDS system
- connection for cuff Ø22mm
- one-handed operation
- power: 350W
- orbit: 2.5mm
- plate: Ø150mm
- height: 94mm
- length: 251mm
- sanding cable: 4m
- weight: 900g

Noise and vibration
15% lower than a
pneumatic sander



350 W



CO 1311	MEDIUM MULTI-HOLE VELCRO® TRAY Ø150mm/8mm	Accessory of OP 1314/OP 1211/OP 1212/OP 1311/OP 1312/OP 1313/OE 1319/OE 1318
CO 1312	3 FLEXIBLE INTERFACES Ø150/5mm	Accessory of OP 1314/OP 1211/OP 1212/OP 1311/OP 1312/OP 1313/OE 1318/OE 1319
CO 1313	3 FLEXIBLE INTERFACES Ø150/10mm	Accessory of OP 1314/OP 1211/OP 1212/OP 1311/OP 1312/OP 1313/OE 1318/OE 1319
SA 1250	EXHAUST HOSE ASSEMBLY Ø32mm L170cm	Accessory of OP 1211/OP 1212/OP 1311/OP 1312/OE 1318/OE 1319

OP 1213

VERTICAL POLISHER Ø150mm



- Composite body
- Auxiliary handle
- Lateral exhaust

Specifications:

- speed: 3,500rpm
- plate: Ø150mm
- length: 165mm
- connector: 1/4"
- supply pressure: 6.2bar
- consumption: 110l/min

Connector supplied



CO 1027

EXPRESS PAINT REMOVER SPRAY 500ml

Allows paint, varnish and ink pickling on every body repair painted element.
Remove burned and imbedded seals (cylinder head, gearbox, water pump, etc).



Active formula: quick and efficient.

It allows you to achieve excellent results with no effort required. Its active formula breaks down problems quickly. This product is suitable for use on solvent-resistant mounts.

Applications: Acrylic, Glycerol, Alkyd, Pliolite...



CO 1001

DARK GREY GARNISHING PRIMER 500ml

Allows application without primer on any support (metal, plastic and aluminum). Removes unevenness, provides a homogeneous and uniform surface before sanding. Filling up to 120µ



Fast drying time
Quick sanding



CO 1042

LIGHT GREY FILLER PRIMER 500ml



CO 1043

WHITE FILLER PRIMER 500ml



CO 1044

BLACK FILLER PRIMER 500ml



CO 1029

BODY REPAIR DEGREASING/CLEANING SPRAY 500ml

Degreases and eliminates silicone anti-static

Allows you to degrease and clean bodywork parts before painting or adhesion. Eliminates residues of glue, grease, oil, silicone.



GUNS

OP 1335

HVLP PROFESSIONAL SPRAY PAINT GUN

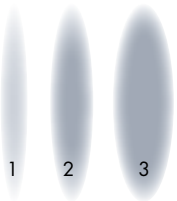

HVLP gravity gun for bodywork and finishing work.

Specifications:

- excellent spread and spray
- reworked ergonomics to make it more comfortable to handle
- stainless steel nozzle, brushed aluminum body Ø2mm
- polyamide tub 600ml
- filter
- service pressure: 1 to 2bar

Connector and Ø2mm nozzle supplied

Connector and Ø2mm nozzle supplied



SA 1312	Ø1.2mm NOZZLE	Accessory of OP 1335
SA 1314	Ø1.4mm NOZZLE	
SA 1316	Ø1.6mm NOZZLE	Accessory of OP 1335
SA 1320	Ø2mm NOZZLE	

OP 1336

MINI PROFESSIONAL SPRAY GUN HVLP



HVLP gravity gun for retouching and finishing.

Specifications:

- excellent spread and spray
- ergonomic, easy to hold
- Ø0.8mm nozzle
- filter
- service pressure: 1 to 2bar

Connector and Ø0,8mm nozzle supplied



OC 0028

MAGNETIC PAINTWORK SUPPORT WITH PLIERS

Flexible

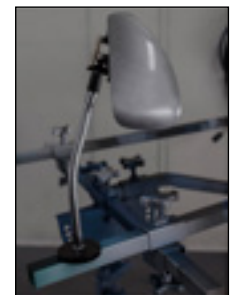
**Specifications:**

- strongly magnetized Ø58mm base to attach to the walls of the paint booth.
- hose
- max. opening: 14mm
- max. load: 2.5kg
- length: 285mm



DRYING

OP 3501

DRYING GUN



Specifications:

- compressed air venturi system
- airflow regulator
- max. flow 6bar
- consumption 350l/min
- noise level in dB: 72dB at 3,5bar
- service pressure 2 to 4bar
- dust filters



OP 0099

STRAIGHT BLOWGUN PEN



- pocket blowgun
- adjustable flow
- duralumin body
- length 110mm
- opening/closure by rotation



OP 3510

2 DRYING GUNS + BASES

Specifications:

- ideal for drying tops and bottoms of vehicles
- fully adjustable base max. 2.08m
- power supply via spiral hose
- fast connectors
- 2 guns can be up to 0.85m apart

OP 3520

4 DRYING GUNS + 2 BASES

Specifications:

- ideal for drying tops and bottoms of vehicles
- fully adjustable base max. 2.08m
- power supply via spiral hose
- fast connectors
- 2 guns can be up to 0.85m apart



STRAIGHTENING HAMMERING TOOLS

OC 0811

HAMMER + BLOCK SET



Contents:

- 3 hammers with GENUINE HICKORY handles L.310mm:
- OC0812: planishing hammer with round flat head and pointed tip
 - OC0813: planishing hammer with round flat head straight tip
 - OC0814: cornering hammer with round and square gridded head

4 blocks:

- OC0815: comma 130x27mm
- OC0816: rail/universal 60x60x56mm
- OC0817: claw 78x60x27mm
- OC0818: anvil 80x62x55mm

NO
WARRANTY

OC 2211

BODYWORK SLIDE HAMMER SET

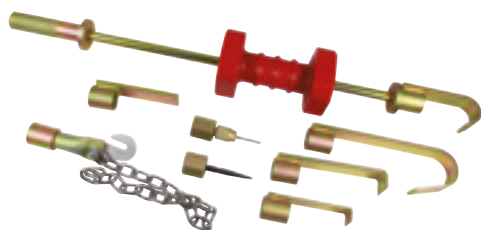

Contents:

- hammer 4.5kg
- stroke 50cm
- handle with guard
- SA4221: pigs tail end
- SA4213: long curved hook 6cm
- SA4214: short curved hook 4cm
- SA4223: 90° hook U
- SA4216: 90° hook flat
- SA4218: straight end
- SA4219: screwed end
- SA4220: chain end



2
WARRANTY

OM 0174

BALL PIN HAMMER 440gr



Made of C45 steel, curved and polished hits, laterally hardened by electro-induction and sandblasted.
Ash handle length 350mm with nylon protection sleeve.
BS 876 standard

NO
WARRANTY

OM 0800

EXTRA FLAT SPLITTING CHISEL

Extra flat splitting chisel - Chrome vanadium steel, can be resharpened.



Standards : DIN 5463

Length: 240mm
Width: 26mm
Thickness: 7mm

NO
WARRANTY

RAMS

OC 0803

4T COLLISION REPAIR SET

Contents:

- SA0805: 4T hydraulic ram
- SA0806: 4T 1/4" hydraulic hand pump
- SA0804: spreader 500kg
- SA0802: hose 1/4"
- bit/support set
- SA1805: bodywork hydraulic ram 4T extension set



SA 0801	MALE HYDRAULIC ADAPTER	Spare part of OC 0803/OC 0804/OC 0801/OC 0802
SA 0803	HYDRAULIC FEMALE ADAPTER	Spare part of OC 0803/OC 0804/OC 0801/OC 0802
SA 0804	SPREADER PLIERS	Spare part of OC 0803/OC 0804/OC 0801/OC 0802
SA 0805	4T HYDRAULIC RAM	Spare part of OC 0803/OC 0801
SA 0806	4T 1/4" HYDRAULIC HAND PUMP	Spare part of OC 0803/OC 0801
SA 0807	10T HYDRAULIC RAM	Spare part of OC 0804/OC 0802 Accessory of OH 3453
SA 0808	10T 1/4" HAND PUMP	Spare part of OC 0804/OC 0802 Accessory of OM 9385/SA 9384/SA 9382/OM 9384/OC 0705

OC 0804

10T COLLISION REPAIR SET



Contents:

- SA0807: 10T hydraulic ram
- SA0808: 10T 1/4" hydraulic hand pump
- SA0804: spreader 500kg
- SA0802: hose 1/4"
- bit/support set
- SA1815: bodywork hydraulic ram 10T extension set



OC 0705**BODYWORK CYLINDER SET
PUSHER/PULLER 1/4"****Contents:**

- SA0704: 1 pusher cylinder 2T H. min. 132mm/H.max. 189mm
- SA0706: 1 pusher cylinder 4T H.min. 275mm/H.max. 405mm
- SA0703: 1 mini puller cylinder 4T H. min. 42mm/H.max. 58mm
- SA0705: 1 mini puller cylinder 10T H. min. 132mm/H. max. 189mm
- SA0707: 1 pusher cylinder 10T H. min.350mm/H. max. 500mm
- SA0709: 1 puller cylinder 2T L.max. 550mm/L.min. 422mm
- SA0708: 1 puller cylinder 5T L.max. 650mm/L. min. 520mm

**OH 0014****AIR HYDRAULIC PUMP 10T 1/4"**

Accessory of DM 0204/OH 3453/OM 9385/OM 9387/
OC 0705/OC 0801/OC 0802/OC 0703/OH 0010



Delivered without hose (SA0802)

Specifications:

- 700bar
- aluminum reservoir
- internal load limiting device
- exhaust muffler
- dimensions: L.255xW.135xH.185mm



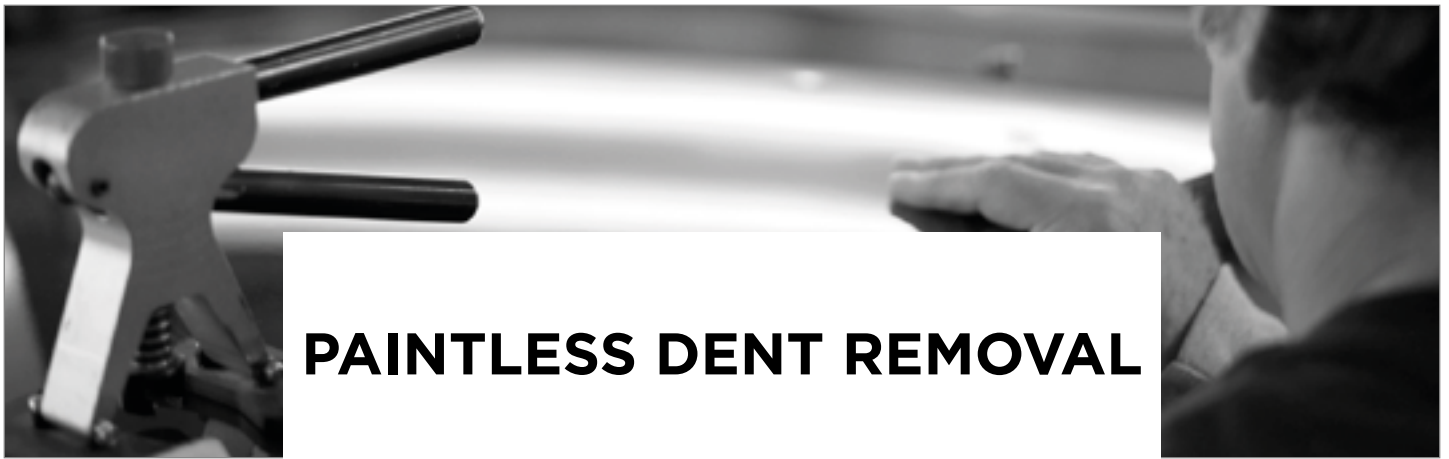

PAINTLESS DENT REMOVAL

OC 8110

SUCTION CUP SUPPORT RODS Ø120mm
CAPACITY 20kg

Accessory of OC 8100



Suction cup for use with paintless bodywork rods (OC8100).
The rods can be passed through 1 of the 5 holes in the strap to act as a pull lever.



OC 0608

DOUBLE SUCTION CUP

Suction strength
60kg
Ø160mm large
suction cup
Ø90mm small
suction cup



OC 0210

MANUAL VACUUM DENT PULLER

Slide hammer for paintless dent removal



Manual pump: does not require external
pneumatic supply

Contents:

- SA0227: suction cup Ø75
- SA0228: suction cup Ø100
- SA0229: suction cup Ø125mm
- SA0224: draw hook
- SA0410: manual pump for venturi

Slide hammer weight : 1.22kg



OC 8100

14 PCS BODYWORK ROD SET



Assortment of 14 auto body work rods not requiring
paint.
Ideal for pushing out hailstone marks, small dents on a
door and other marks.
Supplied in a carry-case.

Rod lengths:

- 350mm
- 700mm
- 900mm
- 750mm
- 700mm
- 750mm
- 300mm
- 280mm
- 300mm
- 300mm
- 450mm



SA 8001 4 END SET Spare part of OC 8100



OC 0113

AUTO DENT REPAIR KIT WITH SLIDE HAMMER

This kit is designed to repair car bodies which have been damaged by hail, or small dents with no need to repaint the part.

The process consists of sticking plastic pulling tips with the gun and the glue especially made for bodywork, and to connect the inertial weight or the pulling lever and then have the painted sheet without damaging it. Then you can remove the pulling end with any cleaning solvent (not supplied) and the nylon chisel.



NEW

Contents:

- SA0112: inertial stainless steel hammer+pulling end
- SA0113: pulling lever (DSP) to remove dents
- SA4205: glue gun 240V-200°C-30W
- 8 glue sticks
- SA0114: 12 pulling tips of various diameters
- SA0115: nylon chisel to remove the pulling tips
- SA0116: bottle of solvent to remove the pulling tips
- 1 strong PVC box



OC 0350

INDUCTION DENT REMOVAL

No preparation work,
no need to repaint

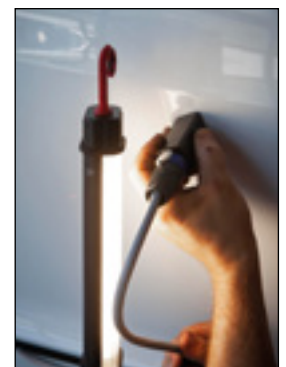

Specifications:

Induction heater allows fast and efficient heating of metal and bodywork parts.
control and regulation of the heating time.
excellent way to repair small dents, such as hail.
Easy to use and use
Time saving through the use of induction technology

NEW



OE 1225

BODYWORK LAMP

Emits parallel beams, highlights bodywork deformations.

Delivered with suction pad



EG 0021

WHITE WASHABLE MARKER FOR ALL SURFACES



Water based washable paint marker

Specifications:

- UV resistant
- for all surfaces: metal, plastic, wood, glass, stone, foil...
- transparent body so you can immediately see how much paint is left
- VOC less than 0.6% (Volatile Organic Compounds)
- complies with standard ASTM D436 (non toxic)



CO 1029

BODY REPAIR DEGREASING/ CLEANING SPRAY 500ml



Degreases and eliminates silicone anti-static

Allows you to degrease and clean bodywork parts before painting or adhesion. Eliminates residues of glue, grease, oil, silicone.



SA 0114

12 PCS PULLING END SET

Spare part of OC 0112/OC 0113

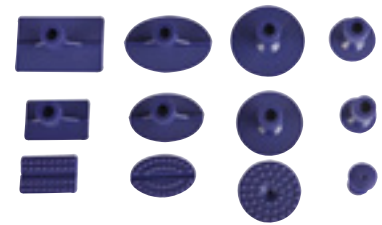

OC 0406

10 WHITE GLUE STICK SET

Ø11mm Intermediate



OC 0405

10 AMBER GLUE STICK SET

Ø11mm Flexible



OC 0403

10 BLACK GLUE STICK SET

Ø11mm Rigid



DOORS & CABIN

HABITACLE

OM 0200

12 PCS AIRBAG MAINTENANCE TOOL SET

Depending on the application, the removal tools are to be used in pairs.



Contents:

- 1/4" tamperproof Torx TB30 special Airbag L.80mm Audi, BMW, Mercedes, Opel etc.
- socket 1/4" Torx T30 L.80mm Audi, VW, Opel, Renault etc.
- socket 1/4" hex 5mm L.80mm Audi etc.
- 1/4" tamperproof Torx socket TB25 special airbag L.80mm BMW etc.
- 1/4" tamperproof Torx socket TB25 special airbag L.80mm BMW etc.
- airbag removal kit - 2 pieces VW Golf IV, New Beetle, Seat, Skoda, Fabia + Octavia 99 etc.
- airbag removal kit - 2 pieces VW Polo 99, Lupo, Passat B5, Audi A4, A6, Skoda Superb etc.
- central flywheel unlocking tools VW Passat 97, Golf IV 98, Golf Bora 99 etc.
- unblocking lever for VW 105x96mm airbags, slot 5.5+8mm
- universal tool of the airbag



OM 0205

CAR-RADIO REMOVAL TOOL KIT

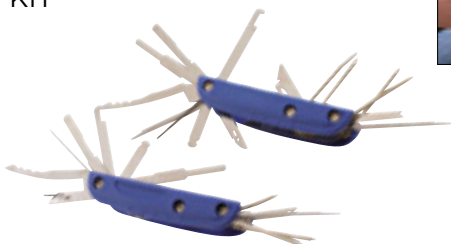

AC 7023

AIRBAG LINE TEST

The tool simulates the presence of the igniter by substituting it with a resistance.



Content:
• 2x2 boxes



OM 2002

PULLER FOR EXTRACTING CONNECTION PLUGS SET

Allows the data sheets from sensors for coolant liquid, connector calculators, wiring harnesses to be extracted... Compatible with VAG connectors.



Preserves wires and cable terminals



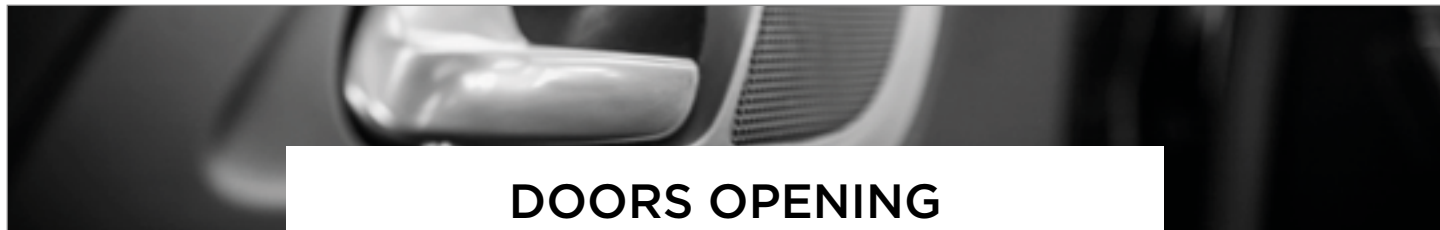

DOORS OPENING

OC 1103

INFLATABLE CUSHION

For keeping pneumatically-operated doors open to make it easier to install windcreens.



Rigid PVC panel:
makes insertion
easier

Cushion dimensions:
155x165mm



OC 9000BL

9 DOOR OPENING SET

Kit comprising tools and rods allowing a vehicle door to be opened without breaking the windows if its keys have been locked inside.

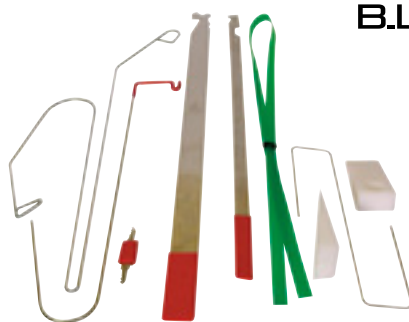

B.LINE



Strictly for professional use
only.
Supplied without
instructions.



EG 0745

SLIP KNOT SEMI-RIGID ROD TO HOOK DOOR HANDLES 1.10m



EG 0743

SEMI-RIGID ROD TO HOOK DOOR HANDLES OR KEYS 1.80m



EG 0742

SEMI-RIGID ROD TO HOOK DOOR HANDLES OR KEYS 1.25m



EG 0744

U-SHAPED SEMI-RIGID ROD TO HOOK DOOR HANDLES 1.50m

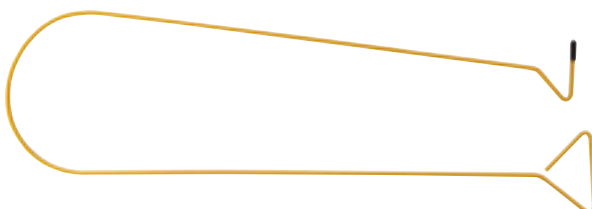

STAPLES

OC 8080

11 PCS NYLON TRIM
REMOVAL SET



Lengths: 160 to 210mm.

NO
WARRANTY

OM 0170

DEAD BLOW
HAMMER WITH
INTERCHANGEABLE TIP
32mm



NEW

Specifications:

- nylon shore 100+92
- ash handle
- length 300mm
- head length 93mm
- complies with DIN 1195 (for the eye) and DIN 5111 (for the handle)



SA 1070 2 INTERCHANGEABLE TIPS 32mm POLYURETHANE

SA 1073 2 INTERCHANGEABLE TIPS 32mm

NO
WARRANTY

OC 8078

5 PCS NYLON TRIM REMOVAL SET



NO
WARRANTY

OC 0033

TRIM CLIP PLIER



2
WARRANTY

SA 0115

PLASTIC CHISEL

Spare part of OC 0112



NO
WARRANTY

OC 8081

TOOL FOR REMOVING DOOR
STAPLES



2
WARRANTY



CLEANING VACUUMS



Specifications:

- stainless steel tank mounted on a 4-wheel dolly
- 2 motors of 1000W each
- 80l tank Ø420mm
- drain on 500mm tank
- pressure: 21kPa
- air flow: 108l/s
- sound level: 73dB
- Power supply- 220V 4m cable
- power: 2000W
- dimension (lengthxdepthxheight): 540x595x940mm

EG 0040

DRY AND WET VACUUM CLEANER 2x1000W

Included accessories:

- SA0442: thin tip with connector Ø42mm
- SA0443: Ø60mm brush with connector Ø42mm
- Ø42mm handle with accessory connector Ø37mm
- SA0440: 2200mm flexible hose Ø42mm
- SA0444: Ø37mm scraper
- SA0445: Ø37mm brush length 400mm
- SA0441: cloth filter



SA 0045	600mm FRONT BRUSH ASSEMBLY WITH HOSE	Accessory of EG 0040
SA 0446	SPIRAL 4000mm Ø42mm	Spare part of EG 0040/EG 0045

EG 0045

**DRY AND WET VACUUM CLEANER
2x1000W+FRONT BRUSH ASSEMBLY 600mm**

Included accessories:

- SA0442: thin tip with connector Ø42mm
- SA0443: Ø60mm brush with connector Ø42mm
- Ø42mm handle with accessory connector Ø37mm
- SA0440: 2200mm flexible hose Ø42mm
- SA0444: Ø37mm scraper
- SA0445: Ø37mm brush length 400mm
- SA0441: cloth filter
- SA0045: front brush assembly 600mm with hose



2000 W



CLEANING AGENT



OE 7201

ULTRASONIC CLEANER 9L 200W 40KHz

Specifications:

- heating temperature adjustable from 0 to 80°C
- timer from 1 to 99 minutes
- heating power: 300W
- digital display
- tank drain valve
- external dimensions: 300x240x150mm
- tray dimensions: 330x310x270mm

OE 7200

ULTRASONIC CLEANER 3L 100W 40KHz

Specifications:

- heating temperature adjustable from 0 to 80°C
- timer from 1 to 99 minutes
- heating power: 100W
- digital display
- tank drain valve
- tray dimensions: 240x140x100mm
- external dimensions: 270x240x170mm

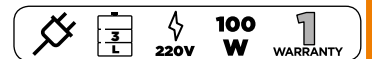
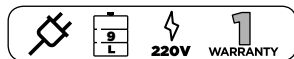

SA 7070

TUB OF ULTRASOUND CLEANING SOLUTION 2L

Accessory of OE 7201/OE 7200/OE 7100

Dilution: 25%



SPRAYERS

OC 1515

PRESSURE FOAM SPRAYER 11l

Especially designed for a careful bodywork cleanup.
Nozzle with diffuser allowing a thick foam jet hooking the bodywork.
Wider base for more stability when filling.
Manual or pneumatic pressurization.



Foam diffuser



Specifications:

- viton seals
- adjustable nozzle
- capacity: 11.2l
- scale: 1l-0.5Gal
- handle with integrated strainer
- hose L.2m
- lance 110° hose L.57cm
- pressure gauge 0-12bar
- pneumatic pressure connection
- max. pressure: 3bar
- side relief valve
- expanded base with consumable storage compartment

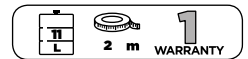

OC 1516

PRESSURE SPRAYER 11l

Especially designed for a careful bodywork cleanup.
Wider base for more stability when filling.
Manual or pneumatic pressurization.



Specifications:

- viton seals
- adjustable nozzle
- capacity: 11.2l
- scale: 1l-0.5Gal
- handle with integrated strainer
- hose L.2m
- lance 110° hose L.60cm
- pressure gauge 0-12bar
- pneumatic pressure connection
- max. pressure: 3bar
- side relief valve
- expanded base with consumable storage compartment

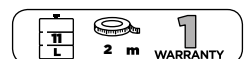

OP 0022

CLEANING GUN



- Cleans bodywork, wheels, dashboard, air vents, engine... and door jambs
- Ultra-low consumption thanks to special vortex technology
- Its vortex propulsion system gives it unbeatable results

Connector supplied



SA 6022	CLEANING SOLUTION	
SA 6032	FULL ROTARY NOZZLE	Spare part of OP 0022
SA 6033	1.2L GRATUATED TANK+CAP	Spare part of OP 0022
SA 6036	GASKET KIT	Spare part of OP 0022
SA 6037	CONE	

OP 0024

CLEANING GUN EVOLUTION

Use it on seats, air vents, gear shift, wheels, ventilation, registration plates, wheel rims...
Easy to carry and non-cumbersome



- encapsulated ball bearing. No rubbing between the bearing and the cone
- reduced wear and tear
- increased efficiency
- improved power
- very fine vaporisation of the liquid for powerful cleaning
- can be used with a solution of water + cleaning solution or water alone

Specifications:

- nozzle rotating speed 4000-8000rpm
- operating pressure 5 to 8 bars
- consumption 180L/min
- bowl capacity 1L
- connector supplied

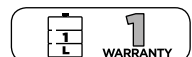

OP 0044

PRO SPRAY GUN



Specifications:

- 2 adjustable jets and air flow
- nozzle L.300mm Ø2mm
- connector 1/4"
- service pressure: 2 to 8bar

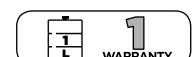



OC 1501

1.5L RED PRESSURE SPRAYER

OC 1502

1.5L BLUE PRESSURE SPRAYER

- viton® seal
- adjustable nozzle



OC 0708

FILM REMOVAL KIT FOR TINTED PANES



Allows tinted films to be removed from glass panes on vehicles.

Contents:

- OE6047: hot hair gun 50-650°C
- CO1029: degreaser/cleaner bodywork spray
- OC0307BL: plastic scrapper
- OC5497: pack of 100 scrapper blades

Supplied in a case



Degreases, Cleans,
Luster and Protects

CO 0400

80 CLEANSING MULTI PURPOSE WIPES

Can be used on all surfaces: bodywork, glazing, leather, interior/ exterior plastics, fairings, optics, chrome, rims, exhausts...etc.

Specifications:

- waterless and rinse-free wipe
- honeycombed surface for better dirt trapping
- dimensions of wipes: 240x190mm

Optimum result when finishing with a microfiber fabric (CO 0401)



MORE

Decree No. 2016-448 of 13 April 2016 (France) amending certain provisions of the Highway Code relating to vehicles

The second, third and fourth paragraphs of Article R. 316-3 are replaced by the following provisions:
 "In addition, the windscreen windows and the driver's and passenger's front side windows shall have sufficient transparency from both the interior and exterior of the vehicle and shall not cause any significant distortion of the objects seen by transparency or any significant change in their colours. The transparency of these panes is considered sufficient if the regular light transmission factor is at least 70 %. In case of breakage, they must allow the driver to continue to see the road clearly."
 "Any operation likely to reduce the safety characteristics or the conditions of transparency of the windows provided for in the preceding paragraphs is prohibited."
 "The Minister responsible for transport shall lay down by order the detailed rules for the application of this Article. In particular, it shall determine the conditions for approval, including transparency, of the various categories of windows fitted to vehicles and, where appropriate, any derogations justified by medical reasons or conditions for fitting armoured vehicles."
 "Contravention of the provisions of this article or of those adopted for its application, with the exception of those relating to the conditions of transparency, shall be punished by the fine provided for contraventions of the third class."

Source: Legifrance.gouv.fr

GLAZING CUTTING

OC 0302

SCRAPER AND UTILITY KNIFE SET



OC 5301	10 PCS BLADE SET 12mm	Spare part of OC 0302
OC 5302	10 PCS STRAIGHT BLADE SET 16mm	Spare part of OC 0302
OC 5303	10 PCS STRAIGHT BLADE SET 20mm	Spare part of OC 0302
OC 5304	10 PCS BEVELLED BLADE SET 16mm	Spare part of OC 0302
OC 5305	10 PCS TRAPEZOIDAL BLADE SET	Spare part of OC 0302/OC 1935



OC 0303

SCRAPER WITH HANDLE + 100 BLADES

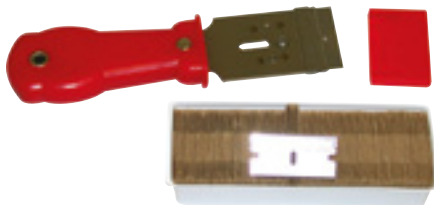

Contents:
OC0304 : 1 x scraper with handle
OC5497 : 1 x 100 scraper blade set



OC 0307BL

PLASTIC SCRAPER

B.LINE



Specifications:

- simple and quick blade changes
- blade protection sheath
- ergonomic
- blade width: 38mm

Blade width: 38mm
Blade height: 19mm



OC 5497 100 SCRAPER BLADE SET Spare part of OC 0303/OC 0304/OC 0305/OC 0306/OC 0307BL

OC 0304

SCRAPER WITH HANDLE



Specifications:

- plastic handle
- metal blade plate
- blade protection sheath
- blade width: 38mm
- blade length: 19mm



Blade width: 38mm
Blade height: 19mm

OC 0305

RETRACTABLE SCRAPER

OC 0306

RETRACTABLE SCRAPER + 100 BLADES

Contents:
OC0305 : 1 x retractable scraper
OC5497 : 1 x 100 scraper blade set



OC 1920

LONG UTILITY KNIFE



Blade width: 18mm

OC 1925

RETRACTABLE UTILITY KNIFE



Blade width: 18mm

OC 1916

10 PCS BREAKABLE BLADE SET

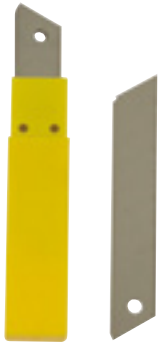

Blade width: 18mm

OC 1915

10 PCS UNBREAKABLE BLADE SET

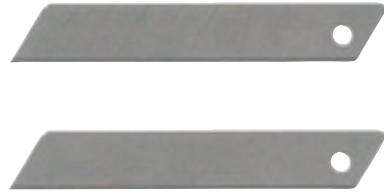

Blade width: 18mm



CO 1023

MULTI-FUNCTIONAL GLUE SPRAY 400ml

Allows headliners, trims, rods, engine foams, upholstery, vinyl, carpet to be glued...



With no filament, it remains flexible after drying

High-adhesion spray for a wide range of uses with high initial resistance. The glue's adhesion properties develop quickly and it is extremely water resistant and long-lasting.



OP 0048**GLASS ENGRAVING CASE**

To be used as a support on the surface to be engraved, combined with a stencil.

Foam tip to perfectly match the relief of the surface to be engraved.
The abrasive remains in the gun: less consumption, no spraying.

**Contents:**

- storage unit with compartments for letters and numbers
- SA6807: stencil kit (letters and numbers 5.2mm)
- SA6804: engraving die for letters or numbers
- SA6805: engraving gun
- SA6803 : filter for engraving gun
- SA6806: container of abrasive sand 1kg

Options:

- SA6808: replacement nozzle
- SA6811: foam disc for the replacement nozzle



SA 6805	ENGRAVING GUN	Spare part of OP 0048
SA 6806	TUB OF ABRASIVE 1kg	Accessory of OP 0048

**OC 2213****WINDSHIELD REPAIR CASE**

This windscreen repair system is designed to comply with the AFNOR NF R 19-601 standard as well as the chemical product standard 1907/2006.

Its operating principle:

- depression in the impact
- resin injection
- control by means of the pump pressure gauge

The intervention is carried out in complete safety, avoiding damage to the windscreen.

**Contents:**

SA2213: vacuum pressure pump (-1/+4bar)
SA2214: injector support with suction cup diam 55mm
SA2215: aluminium injector delivered with 2 seals
CO2216: 25 doses repair 5ml (2 impacts) for impact without cracking
CO2217: 25 doses repair 5ml (2 impacts) cracks,

and finishes

SA4104: UV mirror lamp
CO2218 : Glycerin gel bottle for suction cup (30ml)
SA4105: 100 sheets mylar UV
OC5497: 6 blades
Delivered in its case

NEW

OC 8067

CARBIDE BIT Ø1mm



OC 8064

FINISH RESIN 5ml



OC 2202

REPAIR RESIN 10ml



EG 0002

WINDSCREEN WASHER
NOZZLE CLEANING TOOL



Specifications:

- dimensions:
950mm with protective cap
870mm without protective cap
- tool diameter: 6mm
- cleaning needle and tracer needle: 0.5mm
- needle length: 13mm



OC 1700BL

WINDSCREEN WIPER REMOVER



B.LINE



Small size

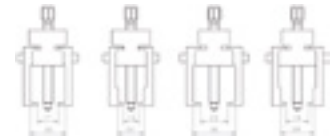

Lets you handle all supports with very effective force.



OC 1710

UNIVERSAL WINDSCREEN WIPER EXTRACTOR

Contents:

- 4 cage extractors Ø26-30mm/Ø31-35mm/Ø36-40mm/Ø36-46mm, internal 45mm, hexagonal drive 12mm
- 1 extractor with internal grips 18-40mm, internal 45mm, hexagonal drive 12mm



OC 2205

INJECTOR



SA 4104

BATTERY OPERATED UV LAMP



OC 1500

2-HANDLE LINE CUTTER KIT



Contents:

- OC2900: pair of pulling handles
- OC2100: sawing wire 0.8mmx0.8mmx44m
- OC4500: hollow starting needle

OC 3401

TRIANGULAR WIRE REEL
50m



OC 3100

CUTTING WIRE
0.7mmx0.7mmx44m



OC 2100

SAWING WIRE
0.8mmx0.8mmx44m



OC 2900

PAIR OF PULLING HANDLES

Quick-lock handles



OC 4500

HOLLOW STARTING NEEDLE

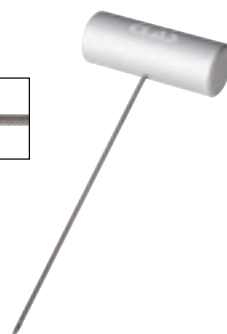

OC 4300

WINDSCREEN LINE INSERTER

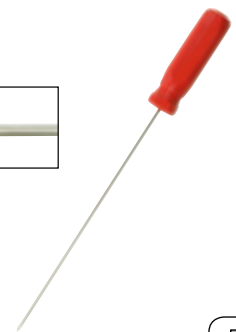

OC 6000

WIRE GUIDE

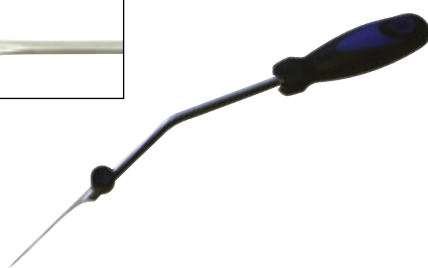

75mm length of flat side

OC 4100

WIRE THREADER





OC 0200

HAND CUTTER



Supplied with 25mm blade

Specifications:

- grooved metal
- t-shaped handle, hose



OC 7025	6 PCS 25mm BLADE SET
OC 7038	7 PCS 38mm BLADE SET



OC 0502

WINDSCREEN GASKET ROLLER TOOL



With its selection of ends, it allows you to position the gasket.



CO 1032

SUPPLE SUPER GLUE 20g



Rapid and instantaneous adhesion



OC 0501

ROPE INSERTION TOOL



Length of the insertion rope: 6m



OC 0301

100 WINDSCREEN PREPARATION TOOL SET



OC 2204

UNIVERSAL GEL FOR ATTACHING RAIN SENSOR/ LIGHT SENSOR (single dose)



OC 6500

ONE-MAN WINDSCREEN RATCHETED REMOVAL KIT

This kit consists of 2 pumped suction cups on a frame that can be attached to a ratcheted cable hoisting system with a pivot on each suction cup to ensure proper adherence to the windscreen.

This technique has the advantage of letting you cut out the windscreen gasket without removing the interior trim. It allows a single operator to remove the windscreen without physical effort.



This tool has been certified by a large number of car makers

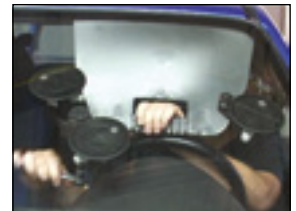
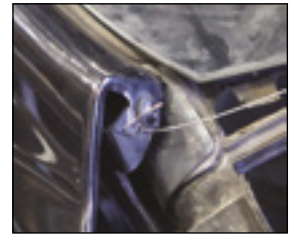

Contents:

- double suction cup cable traction system with ratchet
- corner guide suction cup
- OC4300: windscreen line inserter
- OC2900: pair of pulling handles
- OC3100: square wire hose reel 0.7x0.7mm 44m
- protective glasses

OC 1401

ONE-MAN WINDSCREEN REMOVAL KIT

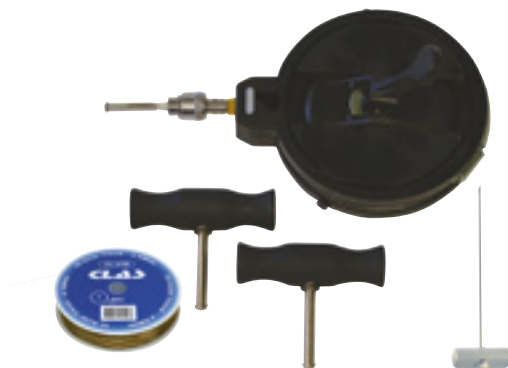

Central suction cup with spring-loaded return lever mounted on swiveling arm.

Contents:

- OC1399: 1 suction cup
- SA4103: 1 reel spring
- OC2100: 1 reel 22m braided line
- OC4500: 1 starting needle
- OC2900: 2 pulling handles



OC 1409

KIT OF 4 WINDSCREEN PROTECTORS

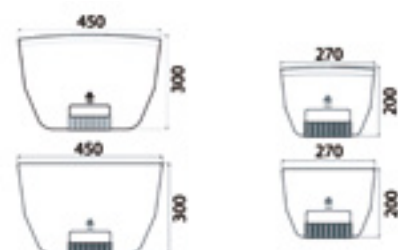

OP 0500

PNEUMATIC KNIFE



- oscillations/min: 20000
- length: 192mm
- supply pressure: 6.2bar
- consumption: 113l/min
- net weight: 1kg

Supplied with conector and 1 OP0557 blade

90 dB
 1.6 m/s²
1 WARRANTY



OP 0508	SCRAPER BLADE 8mm	Accessory of OP 0500
OP 0535	STRAIGHT BLADE 35mm	Accessory of OP 0500
OP 0536	U-SHAPED BLADE 36mm	
OP 0557	STRAIGHT BLADE 57mm	
OP 0590	STRAIGHT BLADE 90mm	Accessory of OP 0500



AC 5028

ELECTRONIC STETHOSCOPE LEAK DETECTOR

The electronic stethoscope allows you, simply by touching with the tip during static testing, to transmit the sound made by the target through headphones to locate engine pinging, bearing noise, slapping, etc. It also lets you detect air leaks normally imperceptible by the human ear by making the ultrasounds made by an airflow audible.



Contents:

- amplifier 176x84x35mm
- ultrasonic transmitter 170x84x36mm
- headphones
- alu stethoscope probe 250mm
- plastic amplifier tube 270mm
- carrying case with foam

Specifications:

- can be operated with 2x9V batteries (6f22 type) or equivalent
- response frequency: 36000Hz to 44000Hz
- operating temperature: 0°C to 40°C
- storage temperature: -10°C to 50°C
- weight: amplifier 183g/transmitter 156g

1 WARRANTY

HANDLING

OC 0713

ADJUSTABLE BODYWORK EASEL WITH TOOL HOLDER



Specially designed foldable trestle to support the bodywork parts (bonnet, door, bumpers...etc.)
Integrated tool tray
6-position setting

Specifications:

Anti-scratch plastic support stands
Stand width: 930mm

6 positions for spacing the stands:

- 300mm (Height: 1090mm)
- 405mm (Height: 1060mm)
- 515mm (Height: 1015mm)
- 625mm (Height: 950mm)
- 730mm (Height: 880mm)
- 845mm (Height: 775mm)

Tray dimensions: L.690xW.340xD.36mm

Dimensions of the folded trestle: L.1110xW.75xD.1125mm



OC 0013

PAIR OF STEPS



Specifications:

Large-size

- max. wheelbase: L.1470xW.690mm
- max height : 710mm
- tray : 950x320mm

Small-size

- max. wheelbase: L.1270xI.570mm
- max. height: 485mm
- tray: 950x320mm



OC 0714

BODYWORK HOLDER

Folding stand specially designed to support body parts (hood, doors, bumper ... etc)



Specifications:

- foam supports
- support length: 100cm
- adjustable spacing by chain
- spacing range: 45 to 90cm
- height: 95 to 48cm according to gauge
- folded dimensions: 102x107x11cm



OC 1720

WINDSCREEN INSTALLATION AND REMOVAL ARM



This arm with 2 suction cups lets you keep the windscreen in place in total safety. With a suction cup on the front windscreen of vehicle, the telescopic arm lets the operator work alone on the windscreen. Suitable for cars, 4x4s, vans.



OC 0666

HANDLE-PUMP SUCTION CUP Ø165mm



Ø165mm



OC 0662

PUMP SUCTION CUP HGV Ø254mm
CAPACITY 140kg



Vacuum pump with brass piston



OC 0667

6 BODYWORK SUCTION CUP SET
Ø85mm

Suction cups for holding lateral sticks, windscreen gaskets, etc, while gluing. Adapts to all shapes and bends in supporting structures as a result of the height adjustment using a butterfly screw system.

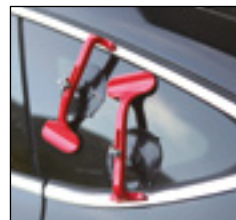

Specifications:

- suction cup Ø85mm
- stand L.180mm
- holding width: 50mm
- bearing surface width: 80mm
- height of the stand adjustable to 32mm
- material: polyethylene and rubber
- adjustment using thumb screw system.



OC 0550BL

PAIR OF SUCTION CUPS Ø115mm

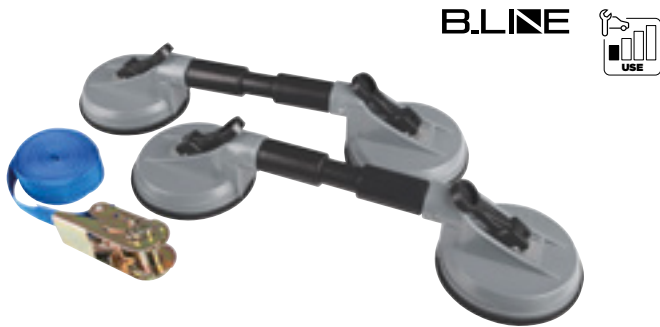

Essential for installing and bonding the new generation of windscreens.

Specifications:

- tilting suction cups to adapt to various glass contours
- lever lock
- carrying handle
- capacity: 60kg
- suction cups Ø115mm
- supplied with fast-ratchet sling
- sling length: 4.7m
- sling length: 2.5cm

Max. Kg
60
NO
WARRANTY

OC 0600

PAIR OF SUCTION CUPS Ø120mm



Essential for positioning and gluing new-generation windscreens.

Specifications:

- swappable suction cups to suit various glass shapes
- lever lock
- carrying handle
- capacity: 120kg
- suction cups Ø120mm
- supplied with fast-ratchet sling
- sling length: 5m

Contents:

- SA6958: Ø120mm suction cups
- SA6959: 5m strap with pawl

Max. Kg
120
2
WARRANTY

OC 0611

PAIR OF SUCTION CUPS Ø140mm



Suction cup
Ø140mm

Max. Kg
120
2
WARRANTY

OC 0665

MINI SUCTION CUP Ø50mm

Ideal for installing and removing small windows or rear view mirrors.

**Specifications:**

- Suction cup Ø50mm
- Max. load: 10kg
- Locking of the suction cup using a lever
- Material: polyethylene and rubber

Max. Kg
10
2
WARRANTY

CO 1041

SCREEN ADHESIVE CARTRIDGE 290ml

Crash Test Approval
Fast drying 1h

**Specifications:**

- MS polymer
- integrated primer
- application width 10 to 14mm
- drying: 2 hours at heart (at 20°C)
- hardness: SHORE 60

NO
WARRANTY

CO 1050

12 CRIMPING NOZZLES 6-12mm
Ø15x1,5mm L.100mm



Output waist width: adjustable from 6 to 12 mm
Adjustable deformation from 0 to 9 mm
Possible cutting right side/left side

CO 1056

12 TAPERED NOZZLES
Ø15x1,5mm L.105mm



CO 1052

12 V-SHAPED NOZZLES
10mm Ø15x1,5mm L.58mm



OC 5071

CARTRIDGE AND BAGS GUN 340mm 12:1



For the application of silicones, adhesives and putties in 310ml cartridges and 300 and 400ml bags.

Specifications:

- aluminum handle, body and ring
- ratio: 12:1
- max. thrust: 4000Nm
- total length: 340mm

Supplied with 1 plastic spout SA5065



OP 5060

PNEUMATIC GUN FOR 370mm CARTRIDGES AND BAGS



For silicones, glues, putties application with 310ml cartridges and 300,400 and 600ml bags.

Specifications:

- aluminum body and ring
- total length: 470mm
- length: 370mm
- height: 270mm
- sound level: 80dB
- air pressure inlet regulator from 4 to 8bar (10bar maximum) with 1/4" connection
- valve strength: 160kgf to 8bar
- progressive trigger to enable speed control

Connector and plastic spout supplied



OP 5061

AIR CAULKING GUN



For the application of silicones, glues and putties with 310ml cartridges.

Specifications:

- aluminum body
- total length: 325mm
- 1/4" connection
- supply pressure: 5bar
- progressive trigger to enable speed control

Connector supplied



HEADLIGHT

HEADLIGHT ADJUSTMENT

AC 3010

DUAL LASER/CAMERA HEADLIGHT ADJUSTER

- Checks and carries out automatic diagnostics of dipped, full beam and anti-fog beams regardless of the type of headlight: LED (Matrix, Intelligent...), xenon, halogen...
- Allows the beam to be checked and automatically measured (using a camera) when lowered and in lateral mode. It also allows you to measure the illumination intensity.
- Centering of the housing using cross-form lasers.
- Conforms to the standard UTAC NFR 63800

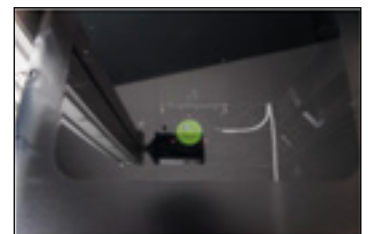

Options (ask us)
- positioning rail

Specifications:

- measuring range:
 - Top and bottom alignment 0-6% (accuracy +/- 0,1%)
 - Right and left alignment 0-10% (accuracy +/- 0,2%)
- light intensity: 150kcd
- 360° rotating aluminum column
- counterweight upward and downward motion
- 3-axis inclinometer compensating for irregularities in the ground electronically
- adjustable castors compensating for significant differences in ground levels
- housing height sensor
- LCD color tactile 5.7" screen
- integrated printer: Registration number/date/test result
- 12V rechargeable battery
- automatic standby
- simple and quick software updates (using a USB key)
- connections: RS232, WiFi, Bluetooth
- communication protocol: Net1, Net2
- dimensions: L.695xI.660xH.1780mm



AC 2013

DUAL LASER HEADLIGHT ADJUSTMENT DEVICE



Specifications:

- laser-type aligner (SA2037) compliant with standard EN 60825
- digital luxmeter
- alu column (collapsible) graduated from 20 to 150cm
- sliding regulating mechanism
- thermoplastic housing with tilt adjustment
- laser aligner power supply: 3 1.5V batteries (supplied)
- dimensions: L.712xW.580xH.1810mm
- UTAC NFR 63801 standard

Functions:

- control and measurement of the closing mechanism 0-4%
- control of the lateral adjustment $\pm 5\text{cm}/10\text{m}$
- measurement of the illumination intensity 0-150klux/1m, 0-240lux/25m
- intervention on headlights (xenon, halogen, LED...), anti-fog



OM 0416

VAG HEADLIGHT ADJUSTMENT TOOL

Designed to tighten/loosen the adjustment knob specific to VAG front headlights.

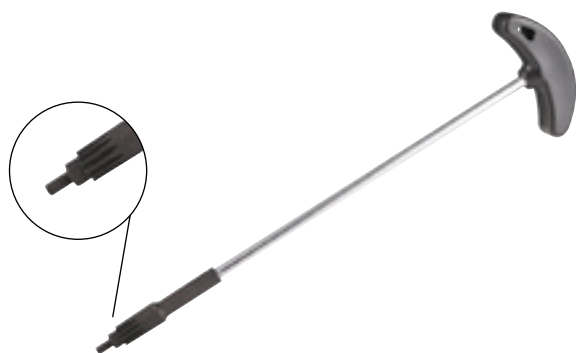

Double hex $\varnothing 13\text{mm}$ with guide

Applications:
Audi: A4 8K, A5 8T, A6 4G
VW: Passat, Touareg



AC 2005BL

STANDARD HEADLIGHT ADJUSTMENT DEVICE



Specifications:

- mirror type aligner
- digital luxmeter
- alu column (collapsible) graduated from 20 to 150cm
- sliding regulating mechanism
- metal housing with tilt adjustment
- power supply: 9V battery (supplied)
- dimensions: L.712xW.580xH.1810mm

Functions:

- control and measurement of the closing mechanism 0-4%
- control of the lateral adjustment $\pm 5\text{cm}/10\text{m}$
- measurement of the illumination intensity 0-150klux/1m, 0-240lux/25m
- intervention on headlights (xenon, halogen, LED...), anti-fog



MORE

Extract from the French Directive SR/V/041 (France)

Specifications for the control of the lightening device adjustment of the vehicle [...] 6. e) allow a measure of the beam lead angle with a maximum measure error between "-0,2%" & "+0,2%" (see example)

Example:
Basis value: 0,5%
Value accepted on the device display: -0,3% to -0,7%.

Source : UTAC
Valid from 2010/01/01

To comply with this directive, your device must be able to justify the drawdown percentage as per the height of the headlight lens.

Annex I : target model

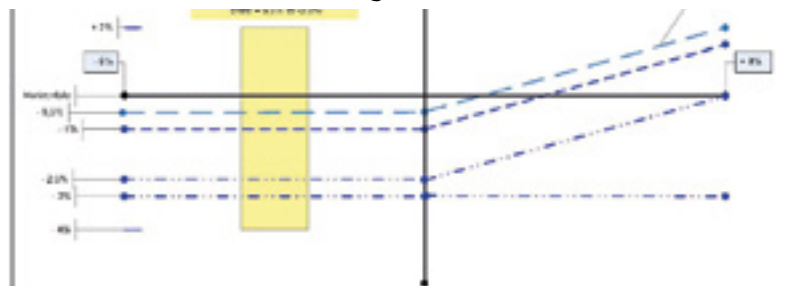

All annotations mentioned in the model are for information purposes only.

REPAIR/REBUILDING

OP 1428

MINI ORBITAL SANDER KIT Ø50-75mm



Contents:

- connector
- SA1428: velcro sanding pad Ø50mm
- SA1429: velcro sanding pad Ø75mm
- 10 sanding discs Ø50mm P320
- 10 sanding discs Ø50mm P400
- 10 sanding discs Ø50mm P600
- 10 sanding discs Ø75mm P320
- 10 sanding discs Ø75mm P400
- 10 sanding discs Ø75mm P600

Specifications:

- speed: 15,000rpm
- pad size: 50-75mm
- length: 108mm
- spindle thread: M6x100
- air consumption: 170l/min



Connector supplied



OP 1429

3" MINI POLISHER KIT Ø75mm



Specifications:

- speed: 3,200rpm
- pad size: 75mm
- spindle thread: M6x100
- air consumption: 170l/min
- length: 115mm



Connector supplied



SA1429 : velcro sanding pad Ø75mm

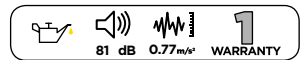

CO 1002

PLASTIC PRIMARY SPRAY
400ml



Allows all plastic surfaces to be primed before painting or gluing.

Colour: transparent



CO 1004

VARNISH SPRAY 1K
400ml



Enables varnishing and protection of finishing paints while providing a glossy finish.
Ideal on body parts (hood, door, wing, underbody, rims...etc)
Transparent, UV and scratch resistant



PLASTIC

REPAIR/REBUILDING

OM 0700

REAR PARKING SENSOR PUNCH TOOL KIT Ø17-Ø22mm

This hollow punch kit allows holes of the required diameter to be punched in the front and rear bumpers in order to install bumper sensors (reversing sensors).



Does not damage
paintwork
No deburring



Specifications:

- tempered steel hollow punch
- max. punch diameter: 4 to 6mm depending on the diameter of the hollow punch
- compatible with pawls and ratchet hammers
- 13mm hex drive

Contents:

- OM0717: Ø17mm hollow punch
- OM0718: Ø18mm hollow punch
- OM0719: Ø19mm hollow punch
- OM0720: Ø20mm hollow punch
- OM0721: Ø21mm hollow punch
- OM0722: Ø22mm hollow punch

Requires a Ø8.5mm pre-punch

OM 0724 REAR PARKING SENSOR PUNCH TOOL Ø24mm

OM 0727 REAR PARKING SENSOR PUNCH TOOL Ø27mm

OM 0730 REAR PARKING SENSOR PUNCH TOOL Ø30mm

OM 0732 REAR PARKING SENSOR PUNCH TOOL Ø32mm BMW/VAG/OPEL

2
WARRANTY

OC 0710

MAGNETIC PAINTWORK SUPPORT FOR REAR PARKING SENSOR L.500mm

Allows up to 10 bumper sensors (reversing radar sensors) to be retained on one support arm for simultaneous painting.

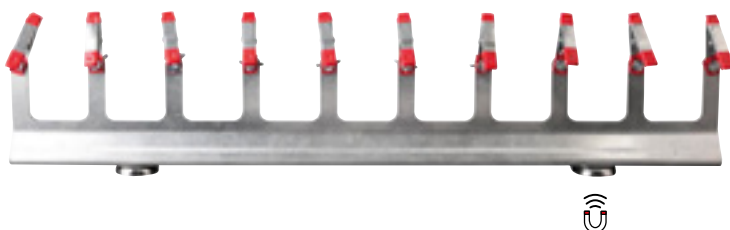

Specifications:

- 2 high-strength magnets
- 10 metallic adjustable clips with plastic protection
- opening of clip: 15mm
- support arm dimensions: 500x135mm

NO
WARRANTY

OC 6060

PLASTIC REPAIR COMPOSITION KIT



NEW

Contents:

- OP1203 : 1 x mini die grinder ø6mm 25,000rpm
- CO1205 : 1 x 50 abrasive discs p80 ø50mm
- CO1201 : 1 x abrasive holder disc tray support axle ø50mm
- CO1202 : 1 x abrasive disc holder tray ø50mm
- CO1029 : 1 x body repair degreasing/cleaning spray 500ml
- OC6045BL : 1 x hot stapler
- OS5001 : 1 x cutting pliers l.160mm
- SA6042 : 1 x soldering iron

- SA6039 : 1 x aerosol coolant for plastic repairs
- OC1025 : 1 x bi-composing gun 50ml
- CO1024 : 1 x black structural glue 50ml
- EG0061 : 1 x metal toolbox 3 storey/6 compartment
- SA6080 : 1 x 5 STAINLESS STEEL GRIDS 150x115mm
- SA6081 : 1 x 6 SOLDERING RODS (PP)
- SA6082 : 1 x 6 SOLDERING RODS (PE)
- SA6083 : 1 x 6 SOLDERING RODS (PS)
- SA6084 : 1 x 6 SOLDERING RODS (ABS)



OE 6047

HOT AIR GUN 50-650°C



Supplied with:

- 1 protective nozzle
- 1 flat nozzle
- 1 reduction nozzle
- 1 reflective nozzle
- 1 scraper

**Specifications:**

- LCD display
- last temperature memorized
- 5 options for airflow from 250 to 500l/min
- heat constant control (protects against overheating and ensures a continuous job)
- handle for a comfortable job
- operating temperature range: 50-650°C

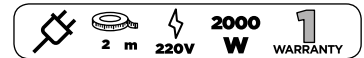
**OC 6049**

PLASTIC REPAIR KIT

**NEW****Contents:**

- SA6042: 1 soldering iron with special soldering tip
- SA6081: 6 brazing rods (PP)
- SA6082: 6 brazing rods (PS)
- SA6083: 6 brazing rods (PE)
- SA6084: 6 brazing rods (ABS)
- SA6080: 5 pieces of 304 stainless steel grids
- soldering iron holder

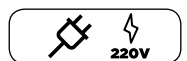
**CO 1003**BUMPER STRUCTURING SPRAY
MEDIUM GRIT 400ml

Allows the irregular granular effect of bumpers to be reformed and masks plastic fillings, welds and repairs.
High covering power.



—————
Scratch-resistant
—————

Specifications:

- medium grit
- black colour

**SA 6039**AEROSOL COOLANT FOR
PLASTIC REPAIRS

OC 1025

BI-COMPOSING GUN 50ml



NEW

Allows the application of two-component adhesives in 50ml cartridges. Delivered with piston 2:1



CO 1024

BLACK STRUCTURAL GLUE 50ml

Accessory of OC 1024



Ideal for plastic repair

Specially for plastic, this glue is perfectly suited for quick adhesion to plastic, metal, glass, wood, stone... Allows you to create material to repair window screens, rods, headlight brackets, rear-view mirror brackets. Can be sanded, ground, drilled, tapped and painted.

Specifications:

- time required for structuring: 1min
- time required for drying: 5min
- 2K polyurethane glue



OC 6045BL

HOT STAPLER



B.LINE



Specifications:

2 stapler positions: straight line and 90°, facilitating application in confined areas. Width of the staples: 13mm Length of the cable: 150cm Stapler dimensions: L.190xW.40mm

Supplied with an assortment of 100 staples Ø0.8mm in U, V and W



SA 6048	100 U-STAPLES Ø0.6mm	Spare part of OC 6048 Accessory of OC 6045BL/OC 6058
SA 6049	100 U-STAPLES Ø0.8mm	Spare part of OC 6048 Accessory of OC 6045BL/OC 6058
SA 6050	100 V-STAPLES Ø0.8mm	Spare part of OC 6048 Accessory of OC 6045BL/OC 6058
SA 6051	100 W-STAPLES Ø0.6mm	Accessory of OC 6048/OC 6045BL/OC 6058
SA 6052	100 W-STAPLES Ø0.8mm	Accessory of OC 6048/OC 6045BL/OC 6058
SA 6053	100 V-STAPLES Ø0.6mm	Accessory of OC 6048/OC 6045BL/OC 6058



DRILLING

OP 1475

AIR RIVETER KIT



Specifications:

- rivet capacity up to 4.8mm depending on the bit
- traction power: 900kg
- stroke length: 14mm
- bits: 2.4-3.2-4-4.8mm
- air inlet: 1/4"
- air pressure: 6.2bar
- consumption: 1.4 to 1.8l/min

Connector supplied

77 dB
 1.01 m/s²
 1 WARRANTY

OM 0749BL

RIVETING PLIERS

B.LINE



Specifications:

- handle sheathed with return spring
- supplied with 4 nozzles Ø2.4-3.2-4.0-4.8mm
- key for nozzle assembly
- length: 270mm

NO
WARRANTY

OM 0480

PRO PLIERS FOR RIVETS & LOCKNUTS

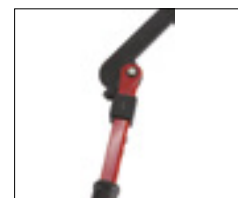

Suitable for:

- rivets Ø2.4-3.2-4-4.8-6.4mm
- locknuts Ø4-5-6-8-10mm

Contents:

- m4-M5-M6-M8-M10 pull spindles
- 3.2-4.0-4.8 et 6.4mm nozzles

SA1489: repair kit for riveting pliers

2
WARRANTY

DRILLING

OP 1450

Ø10mm REVERSIBLE DRILL



- Two-speed trigger
- Automatic chuck
- Silent
- Composite housing
- Ergonomic handle
- Swivelling connector
- Bottom exhaust with silencer
- Reversing bar on both sides
- Inversion of the rotation direction with one hand accessible from both sides

Specifications:

- motor: 0.5cv
- speed: 1800rpm
- length: 185mm
- connector: 1/4"
- supply pressure: 6.2bar
- consumption: 113l/min

Connector supplied



EG 0680

25PCS DRILL SET
HSS COBALT 5%

NEW



Contents:
Drills from 1.0 to 13.0mm, every 0.5mm

NO
WARRANTY

EG 0681

170PCS DRILL SET HSS COBALT 5%

NEW



Contents:

- 10 drills from 1 to 8mm, every 0.5mm
- 5 drills from 8.5 to 10mm, every 0.5mm

NO
WARRANTY

EG 5033

9 LETTER PUNCH SET DIN 8mm



EG 5031

9 LETTER PUNCH SET DIN 10mm

EG 5032

27 LETTER PUNCH SET DIN 8mm



EG 5030

27 LETTER PUNCH SET DIN 10mm

NO
WARRANTY

REF	PAGE	REF	PAGE	REF	PAGE	REF	PAGE
5100167.3	31	AC 0519	252	CO 1018	181	DM 1204	307
5100168.3	31	AC 0520	52-231-252	CO 1019	249	DM 1303	309
5100173.2	34	AC 0528	52-230	CO 1020	49-225	DM 1304	307
5100174.3	31	AC 0530	53-231	CO 1022	49-334	DM 1306	309
5100179.2	34	AC 0800	226	CO 1023	48-356	DM 1307	309
5100180.3	32	AC 0810	192	CO 1024	49-374	DM 1308	308
5100182.3	32	AC 1002	200	CO 1025	215	DM 1309	309
5100221.3	31	AC 1017	248	CO 1026	47-283	DM 1310	309
5100238.2	34	AC 1018	249	CO 1027	47-182-334-338	EG 0002	358
5100239.2	34	AC 1019	249	CO 1029	47-182-338-346	EG 0007	260
5100240.4	31	AC 1023	250	CO 1030	48	EG 0012	28
5100262.2	34	AC 1104	202	CO 1031	48	EG 0013	28
5100263.2	34	AC 2005BL	369	CO 1032	50-360	EG 0014N	28
5100298.5	31	AC 2013	368	CO 1033	334	EG 0015	28
5100379.3	32	AC 2021	227	CO 1034	333	EG 0017	29-72
51004321	33	AC 2024	227	CO 1035	47-331-334	EG 0021	346
5100434.2	33	AC 3010	367	CO 1037	309	EG 0040	177-350
5100436.2	33	AC 3300	201-225	CO 1038	50-228	EG 0045	177-350
5100510	33	AC 3350	201-225	CO 1039	50-228	EG 0047	21-328
5100512	33	AC 4008	251	CO 1041	365	EG 0050	21-328
5100611.3	30	AC 4012	214	CO 1042	338	EG 0055	335
60008001	35	AC 4015	214	CO 1043	338	EG 0056	178-327
60011071	37	AC 4023	214	CO 1044	338	EG 0061	95
60011241	37	AC 4034	251	CO 1046	49-327	EG 0065	102
6001132	37	AC 4052	246	CO 1047	49-334	EG 0070	100
60011731	36	AC 4053	246	CO 1048	49-334	EG 0080	101
6001180	36	AC 4054	251	CO 1049	24	EG 0083	40-99
60011831	36	AC 4066	192-201	CO 1050	366	EG 0086	99
6001190	36	AC 4097	191	CO 1052	366	EG 0087	98
60011951	36	AC 4223	250	CO 1053	249	EG 0090	97
6001202	36	AC 4224	250	CO 1054	49	EG 0091	97
6001210	35	AC 4228	250	CO 1056	366	EG 0097	96
62221610N	316	AC 5004	252	CO 1057	333	EG 0106	42
62221810	316	AC 5014	252	CO 1058	333	EG 0108	42-323
710015	317	AC 5028	247-362	CO 1070	250	EG 0109	42
710016	318	AC 5103	52	CO 1201	86-329	EG 0111	299
710017	317	AC 5110	24	CO 1202	86-329	EG 0221	41
710018	318	AC 5111	19	CO 1203	86-329	EG 0225	41
710050	318	AC 5115	22	CO 1204	86-329	EG 0273	41
72142610	302	AC 5222BL	241	CO 1205	86-329	EG 0335	39
72142810	300	AC 5244	240	CO 1209	329	EG 0336	39
721435	303	AC 5245	240	CO 1218	78	EG 0337	39
721436	301	AC 5280	215	CO 1311	87-337	EG 0340	39
721602	311	AC 7023	347	CO 1312	87-337	EG 0341	39
721603	310	AC 7495	248	CO 1313	87-337	EG 0344	39-101
7700023	38	AC 9901	194	CO 1530	182	EG 0346	39-101
7700024	38	CO 0400	50-182-354	CO 4065	247	EG 0347	39-101
7700025	38	CO 0401	50	CO 4068	247	EG 0357	39
7700083	38	CO 0500	50-182-308	CO 4069	247	EG 0405	183
AC 0010	230	CO 0525	55-135	CO 4074	249	EG 0406	183
AC 0011	230	CO 0526	55-135	CO 4077	246	EG 0409	183
AC 0118	228	CO 0527	55-135	CO 4078	246	EG 0421	184
AC 0200	227	CO 1001	338	CO 4079	246	EG 0422	185
AC 0224	227	CO 1002	370	CO 4081	247	EG 0423	185
AC 0511	53-231	CO 1003	373	DM 0106	306	EG 0424	186
AC 0513	53-231	CO 1004	370	DM 0200	306	EG 0428	186
AC 0514	52	CO 1005	224	DM 1000	304	EG 0432	44
AC 0515	52	CO 1010	224	DM 1101	306	EG 0525	55
AC 0517	52-230	CO 1012	201	DM 1105	308	EG 0526	19
AC 0518	53-231	CO 1014	225			EG 0540	21

INDEX • ALPHANUMERICAL

REF	PAGE	REF	PAGE	REF	PAGE	REF	PAGE
EG 0541	21	HU 0005	171	HU 2004	195	KR 7042	65
EG 0565	260	HU 0008	191	HU 2006	195	KR 7043	65
EG 0607	168	HU 0010BL	191	HU 2016	175	KR 7044	65
EG 0670BL	44	HU 0011	170	HU 2019	197	KR 7045	65
EG 0671BL	43	HU 0013	170-193	HU 2024	195	KR 7046	65
EG 0680	44-376	HU 0014	191	HU 2027	190	KR 7047	65
EG 0681	43-376	HU 0014BL	170	HU 2050	197	KR 7048	65
EG 0742	348	HU 0031	169	HU 2236	195	KR 7049	65
EG 0743	348	HU 0033	199	HU 2258	195	KR 7050	65
EG 0744	348	HU 0035	169	HU 4029	202	KR 7051	65
EG 0745	348	HU 0079BL	198	HU 4030	226	KR 7052	65
EG 0809	261	HU 0114	199	HU 4031	226	KR 7053	65
EG 1050	28	HU 0120	174	HU 8005	234	KR 7054	65
EG 1135	166	HU 0121	174	HU 9257	195	KR 7055	65
EG 1136	168	HU 0139	199	KR 2016	63	KR 7056	65
EG 1137	168	HU 0149N	198	KR 3020	63	KR 7057	65
EG 1138	168	HU 0159N	198	KR 4425	63	KR 7058	65
EG 1139	166	HU 0180N	198	KR 6032	62	KR 7059	65
EG 1140	166	HU 0220	174	KR 7000	64	OC 0013	363
EG 1141	166	HU 0230	174	KR 7001	64	OC 0025	328
EG 1142	166	HU 0235	174	KR 7002	64	OC 0028	339
EG 1143	168	HU 0240	174	KR 7003	64	OC 0033	349
EG 1144	167	HU 0250	175	KR 7004	64	OC 0113	345
EG 1145	167	HU 0255	175	KR 7005	64	OC 0200	360
EG 1146	167	HU 0260	176	KR 7006	64	OC 0210	344
EG 1147	167	HU 0265	174	KR 7007	64	OC 0215	327
EG 1148	167	HU 0290	176	KR 7008	64	OC 0221	326
EG 1149	167	HU 0440	174	KR 7009	64	OC 0301	360
EG 1151	168	HU 0450	175	KR 7010	64	OC 0302	51-355
EG 1152	168	HU 0511	44-171	KR 7011	64	OC 0303	51-355
EG 1184	103	HU 0512	91-173	KR 7012	64	OC 0304	355
EG 1185	103	HU 0513BL	172	KR 7013	64	OC 0305	355
EG 1203	103	HU 0514	172	KR 7014	64	OC 0306	51-355
EG 1530	178	HU 0550	258	KR 7015	64	OC 0307BL	51-355
EG 1560	53-230	HU 0613	173	KR 7016	64	OC 0350	345
EG 2185	104	HU 0617	73-173	KR 7017	64	OC 0403	346
EG 2203	104	HU 0619N	173	KR 7018	64	OC 0405	346
EG 3200	184	HU 0620	172-199	KR 7019	64	OC 0406	346
EG 3228	105	HU 0629	171	KR 7020	64	OC 0501	360
EG 3521	181	HU 0631	172-199	KR 7021	64	OC 0502	360
EG 4197	106	HU 0637	171	KR 7022	64	OC 0550BL	365
EG 5030	148-376	HU 0638	171	KR 7023	64	OC 0600	365
EG 5031	148-376	HU 0640	193	KR 7024	64	OC 0608	344
EG 5032	148-376	HU 0645	171	KR 7025	64	OC 0611	365
EG 5033	148-376	HU 0647	171	KR 7026	64	OC 0662	364
EG 7050	41	HU 0650	171	KR 7027	65	OC 0665	365
EG 7051	41	HU 0657BL	170	KR 7028	64	OC 0666	364
EG 7053	41	HU 0700	256	KR 7029	64	OC 0667	364
EG 7054	41	HU 1102	257	KR 7030	64	OC 0705	343
EG 8001	101	HU 1103	257	KR 7031	64	OC 0708	354
EG 8004	100	HU 1108	233	KR 7032	64	OC 0710	371
EG 8006	100	HU 1109	256	KR 7033	64	OC 0711	40-323
EG 8007	100	HU 1113	258	KR 7034	64	OC 0713	363
EG 8008	100	HU 1116	233	KR 7035	65	OC 0714	363
EG 8009	101	HU 1117	233	KR 7036	65	OC 0716	324
EQ 1000	312	HU 1316	73	KR 7037	65	OC 0717	324
EQ 8093	314	HU 1818	73-173	KR 7038	65	OC 0780	324
EQ 8421	314	HU 1992	196	KR 7039	65	OC 0803	342
EQ 9400	314	HU 1999	196	KR 7040	65	OC 0804	342
HU 0002	171	HU 2002	197	KR 7041	65	OC 0811	147-341

REF	PAGE	REF	PAGE	REF	PAGE	REF	PAGE
OC 0812	147	OC 9000BL	348	OE 5036	250	OH 8006	200
OC 0813	147	OE 0017BL	14	OE 5051	243	OH 8010	264
OC 0814	147	OE 0036	22	OE 5052	243	OH 8011	265
OC 0815	147	OE 0041	66	OE 5115	23	OH 8012	263
OC 0816	147	OE 0042	14	OE 5116	23	OH 9000	299
OC 0817	147	OE 0051	66	OE 6047	21-373	OH 9001	299
OC 0818	147	OE 0052	68	OE 7200	181-214-351	OH 9021	163
OC 1025	91-374	OE 0055	17	OE 7201	181-214-351	OH 9032N	165
OC 1103	348	OE 0065BL	22	OH 0009	153-175	OH 9042N	164
OC 1200	322	OE 0085	15	OH 0011	270	OH 9150	162-321
OC 1401	361	OE 0086	14	OH 0014	343	OM 0024	116
OC 1409	361	OE 0094	15	OH 0017	270	OM 0043	121-124
OC 1500	359	OE 0098	14	OH 0018	270	OM 0044	121
OC 1501	178-354	OE 0129	16	OH 0019	270	OM 0045	121
OC 1502	178-354	OE 0131	12	OH 0025	219	OM 0047	109
OC 1510	178	OE 0132	12	OH 0235	162	OM 0065	121
OC 1515	94-179-352	OE 0143	13	OH 0236	234	OM 0066	288
OC 1516	94-179-352	OE 0143R	13	OH 0237	234	OM 0070	216
OC 1700BL	358	OE 0144	11	OH 0238	153	OM 0071	216
OC 1710	358	OE 0145BL	13	OH 0266	162	OM 0075	221
OC 1720	364	OE 0178	17	OH 0273	162	OM 0080	216
OC 1915	51-356	OE 0302	27	OH 0335	154	OM 0099	42
OC 1916	51-356	OE 0303	27	OH 0336NBL	154	OM 0103	229
OC 1920	51-356	OE 0305	27	OH 0338	154	OM 0104	229
OC 1925	51-356	OE 0311	27	OH 0570	270-281	OM 0106	229
OC 2100	359	OE 0332	27	OH 0579	269	OM 0109	229
OC 2202	358	OE 0335	25	OH 0821	152	OM 0111	135
OC 2204	360	OE 0350	25	OH 0831	152	OM 0112	204-231
OC 2205	358	OE 0395	16	OH 0833	152	OM 0125	146
OC 2211	341	OE 0396	16-246	OH 0851	152	OM 0135	146-287
OC 2213	357	OE 0423	68	OH 0921	150	OM 0150	204
OC 2900	359	OE 0610	57	OH 0931	151	OM 0151	206
OC 3100	359	OE 0700	26	OH 0951	151	OM 0152	206
OC 3401	359	OE 0710	27	OH 1001	153	OM 0153	229
OC 4100	359	OE 0715	27	OH 1300	40-153	OM 0154	229
OC 4300	359	OE 0720	29	OH 3015N	164	OM 0155	229
OC 4500	359	OE 0721	27	OH 3512	279	OM 0156	121-288
OC 5071	90-366	OE 0750	27	OH 4502	157	OM 0157	206
OC 5301	355	OE 0755	29	OH 4504	157	OM 0158	206
OC 5302	355	OE 0756	28	OH 4506	157	OM 0159	228
OC 5303	355	OE 0800	57	OH 4512	157	OM 0160	145
OC 5304	355	OE 0811	21-328	OH 4520	157	OM 0161	145
OC 5305	355	OE 0900	56	OH 4530	157	OM 0170	145-349
OC 5497	51-355	OE 1224	326	OH 4550	157	OM 0174	147-341
OC 6000	359	OE 1225	346	OH 5020	266	OM 0200	347
OC 6041	323	OE 1318	337	OH 5022	284	OM 0205	20-347
OC 6045BL	374	OE 1319	337	OH 5030N	165	OM 0220	260
OC 6049	373	OE 2000	67	OH 5302BL	159	OM 0255	307
OC 6060	372	OE 2001	67	OH 5303	161	OM 0258	149
OC 6500	361	OE 2060	79-315	OH 5304	159	OM 0259	307
OC 7025	360	OE 2065	79	OH 5306	160	OM 0300	290
OC 7038	360	OE 3004	22	OH 5309	160	OM 0301	293
OC 8034	314	OE 3008BL	22	OH 5311	159	OM 0302	211
OC 8064	358	OE 3010	26	OH 5355	163	OM 0304	211
OC 8067	358	OE 3020	20	OH 5360	163	OM 0305	292
OC 8078	349	OE 3025	20	OH 6014	161	OM 0306	289
OC 8080	349	OE 3030	19	OH 6035	161	OM 0307	292-293
OC 8081	349	OE 3150	22-241	OH 8001	262	OM 0308	292
OC 8100	344	OE 4002	26	OH 8002	263	OM 0309	292
OC 8110	344	OE 5020	23	OH 8005	209-242	OM 0311	293

INDEX • ALPHANUMERICAL

REF	PAGE	REF	PAGE	REF	PAGE	REF	PAGE
OM 0312	293	OM 0387	291	OM 0503	228-254	OM 0800	149-341
OM 0313	290	OM 0388	291	OM 0504	189	OM 0801	149
OM 0315	190	OM 0389	295	OM 0511	239	OM 0802	149
OM 0316	190	OM 0390	253	OM 0512	239	OM 0803	149
OM 0318	289	OM 0391	253	OM 0513	239	OM 0804	149
OM 0319	289	OM 0392	271	OM 0514	239	OM 0805	149
OM 0320	253	OM 0393	271	OM 0515	239	OM 0806	149
OM 0321	291	OM 0394	271	OM 0521	207	OM 0810	149
OM 0322	291	OM 0395	271	OM 0522	207	OM 0950	141
OM 0324	295	OM 0396	286	OM 0523	207	OM 1100	274
OM 0325	204	OM 0397	286	OM 0525	207	OM 1101	274
OM 0326	204	OM 0400	124-286	OM 0527	207	OM 1103	274
OM 0327	204	OM 0401	124-286	OM 0531	210	OM 1104	274
OM 0328	204	OM 0402	124-286	OM 0540	146	OM 1105	274
OM 0329	298	OM 0403	124-286	OM 0556	239	OM 1107	274
OM 0330	298	OM 0416	368	OM 0560	238	OM 1108	274
OM 0331	294	OM 0418	261	OM 0561	238	OM 1109	274
OM 0332	298	OM 0420	261	OM 0562	238	OM 1112	275
OM 0333	298	OM 0423	261	OM 0563	238	OM 1114	274
OM 0334	296	OM 0424	261	OM 0565	124-288	OM 1115	274
OM 0335	296	OM 0426	261	OM 0567	124-288	OM 1316	308
OM 0336	288	OM 0450	46	OM 0580	148	OM 2002	20-347
OM 0337	195	OM 0452	46	OM 0581	148	OM 2013	156
OM 0339	206	OM 0453	46	OM 0585	124-288	OM 2024	322
OM 0340	206	OM 0454	46	OM 0586	287	OM 2332	122
OM 0341	294	OM 0455	46	OM 0587	287	OM 2333	118
OM 0342	287	OM 0456	46	OM 0588	287	OM 2334	118
OM 0343	288	OM 0457	46	OM 0589	287	OM 2335	118
OM 0344	267	OM 0458	46	OM 0610	189	OM 2336	119
OM 0345	269	OM 0459	46	OM 0614	229	OM 2337	119
OM 0346	209	OM 0460	235	OM 0617	232	OM 2338	144
OM 0348	211	OM 0461	236	OM 0618	232	OM 2354BL	126
OM 0349	267	OM 0462	235	OM 0621	232	OM 2355BL	123
OM 0350	290-293	OM 0465	237	OM 0623	271	OM 2501BL	266
OM 0351	295	OM 0466	237	OM 0639	232	OM 2502BL	266
OM 0352	289	OM 0467	237	OM 0640	141	OM 2503BL	266
OM 0353	290	OM 0468	237	OM 0643	44-330	OM 2510BL	266
OM 0354	290	OM 0469	237	OM 0645	109	OM 2555	116
OM 0355	298	OM 0470	236	OM 0649	82	OM 2600BL	266
OM 0357	253	OM 0475	235	OM 0653	44	OM 3002BL	155
OM 0358	253	OM 0476	236	OM 0655BL	143	OM 3021	156
OM 0359	253	OM 0477	236	OM 0666	224	OM 3023	156
OM 0366	212	OM 0478	235	OM 0669	141-254	OM 3030	155
OM 0370	296	OM 0479	282-294	OM 0684	156	OM 3060	155
OM 0371	296	OM 0480	82-375	OM 0700	371	OM 3100	155
OM 0372	297	OM 0481	209	OM 0724	371	OM 3409	283
OM 0373	296	OM 0482	209	OM 0727	371	OM 3418	283
OM 0374	297	OM 0483	209	OM 0730	371	OM 3419	152
OM 0375	297	OM 0484	209	OM 0732	371	OM 3423	282
OM 0376	298	OM 0486	46	OM 0749BL	82-375	OM 3455	284
OM 0377	298	OM 0487	46	OM 0750	128	OM 3517BL	282
OM 0378	298	OM 0488	46	OM 0764BL	128	OM 3615	267
OM 0379	298	OM 0489	46	OM 0765	128	OM 3637BL	274
OM 0380	298	OM 0490	46	OM 0769	128	OM 3674	205
OM 0381	298	OM 0491	208	OM 0772	127	OM 3685	204
OM 0382	294	OM 0492	208	OM 0776	127	OM 3686	205
OM 0383	294	OM 0493	208	OM 0778	127	OM 3787	245
OM 0384	289	OM 0494	208	OM 0779	127	OM 3788	245
OM 0385	292	OM 0499	208	OM 0784	127-275	OM 3789	213
OM 0386	291	OM 0501	260	OM 0790BL	128	OM 3970	210-234

REF	PAGE	REF	PAGE	REF	PAGE	REF	PAGE
OM 3971	210-234	OM 8022	254	OM 9389	203	OP 0718	74
OM 3980	237	OM 8023	254	OM 9390	203	OP 0719	74
OM 3986	237	OM 8029	261	OM 9391	279	OP 0720	74
OM 3987	237	OM 8043	259	OM 9392	19	OP 0721	74
OM 4022	218	OM 8047	259	OM 9393	19	OP 0722	74
OM 4024	288	OM 8050BL	259	OM 9398	189	OP 0723	74
OM 4025	207	OM 8052	254	OM 9410	222	OP 0724	74
OM 4033	217	OM 8053	254	OM 9411	222	OP 0727	76
OM 4044	213	OM 8057	260	OM 9412	222	OP 0901	69-70-75
OM 4052	207	OM 8069	325	OM 9420	222	OP 0902	75
OM 4055	211	OM 8071	54	OM 9421	222	OP 0903	75
OM 4066	41	OM 8074	54	OM 9422	222	OP 0904	75
OM 4068	41	OM 8080	325	OM 9432	221	OP 0906	75
OM 4100	295	OM 8081	325	OM 9433	221	OP 0907	71-75
OM 4202	217	OM 8082	325	OM 9441	220	OP 0908	75
OM 4224	217	OM 8083	325	OM 9442	221	OP 0909	75
OM 4480	295	OM 8086	54	OM 9443	222	OP 0910	75
OM 4526	261	OM 8087	54	OP 0022	94-180-353	OP 0911	75
OM 4528	231	OM 8088	54	OP 0024	94-180-353	OP 0912	75
OM 4532	267	OM 8090	260	OP 0044	94-178-353	OP 0913	75
OM 4533	267	OM 8157	260	OP 0046BL	69-306	OP 0914	75
OM 4535	126-287	OM 8158	255	OP 0048	93-357	OP 0915	75
OM 5010	203	OM 8168	255	OP 0049	69-306	OP 0916	75
OM 5014	203	OM 9002	299	OP 0053BL	258	OP 0917	74
OM 5020	203	OM 9100BL	223	OP 0082BL	69	OP 0918	74
OM 5023	277	OM 9110	223	OP 0099	69-76-340	OP 0919	74
OM 5024	203	OM 9175	268	OP 0102	230	OP 0920	74
OM 5026	225	OM 9208	284	OP 0209	158	OP 1017	71
OM 5030	203	OM 9210	190	OP 0309	158	OP 1115	70
OM 5038	212	OM 9213	244	OP 0375	76	OP 1117	70
OM 5041	212	OM 9216	212	OP 0420	69-76	OP 1126	72
OM 5044	203	OM 9221	45	OP 0452	158	OP 1203	86-329
OM 5083	218	OM 9222	45	OP 0500	84-362	OP 1204	86
OM 5084	218	OM 9223	45	OP 0501	258	OP 1205	86-329
OM 5085	218	OM 9254	120	OP 0508	362	OP 1206	84-330
OM 5104	203	OM 9261	216	OP 0521	91	OP 1207	84
OM 5105	203	OM 9267	190	OP 0535	362	OP 1209	78
OM 5310	221	OM 9273	254	OP 0536	362	OP 1210	85-331
OM 5412BL	282	OM 9275	223	OP 0557	362	OP 1213	89-337
OM 6058	216	OM 9276	220	OP 0590	362	OP 1214	84-330
OM 6100	205	OM 9277	217	OP 0615	93-332	OP 1218	81
OM 7003BL	115	OM 9300	45	OP 0617	93-332	OP 1231	85
OM 7005	140	OM 9311	285	OP 0618	93	OP 1232	85
OM 7006	107	OM 9325	45	OP 0659	306	OP 1311	87-336
OM 7008	308	OM 9330	268	OP 0679	306	OP 1312	87-336
OM 7009	119	OM 9336	190	OP 0701	69-70-75	OP 1335	92-339
OM 7013	112	OM 9339	191	OP 0702	71-75	OP 1336	92-339
OM 7017	112	OM 9344	285	OP 0703	75	OP 1338	91-333
OM 7018	113	OM 9354	120	OP 0704	75	OP 1402	78
OM 7019	107	OM 9366	219	OP 0705	75	OP 1404	244
OM 7025	115-286	OM 9370	279	OP 0706	75	OP 1405	80-315
OM 7036	115	OM 9371	223	OP 0708	75	OP 1407	80-315
OM 7047	113	OM 9373	278	OP 0709	75	OP 1409	80
OM 7051	209	OM 9381	280	OP 0710	75	OP 1413	77
OM 7069	116	OM 9383	277	OP 0711	75	OP 1418	77
OM 7112	120	OM 9384	278	OP 0712	75	OP 1419	78
OM 7113	120	OM 9385	276	OP 0713	75	OP 1420	80
OM 7146	116	OM 9386	276	OP 0715	75	OP 1422	80
OM 7450	228	OM 9387	279	OP 0716	75	OP 1428	89-370
OM 7820	269	OM 9388	280	OP 0717	74	OP 1429	89-370

INDEX • ALPHANUMERICAL

REF	PAGE	REF	PAGE	REF	PAGE	REF	PAGE
OP 1445	88-331	OS 1199	137	OS 3090	116	OS 3220	108-140
OP 1450	81-376	OS 2000	138	OS 3091	116	OS 3221	140
OP 1451	81	OS 2001	138	OS 3092	116	OS 3222	140
OP 1460	81-328	OS 2002	138	OS 3093	116	OS 3223	140
OP 1465	307	OS 2003	138	OS 3094	116	OS 3224	140
OP 1470	83-331	OS 2004	138	OS 3095	116	OS 3225	140
OP 1475	82-375	OS 2005	138	OS 3096	116	OS 3226	140
OP 1480	83-219-269	OS 2006	138	OS 3097	116	OS 3227	140
OP 1481	94-333	OS 2007	138	OS 3100	113	OS 3228	140
OP 1502	78	OS 2099	138	OS 3101	111	OS 3229	140
OP 1510	77	OS 2100	139	OS 3102	111	OS 3230	108-143
OP 1513	78-315	OS 2101	139	OS 3103	111	OS 3231	142
OP 1532	79	OS 2102	139	OS 3104	111	OS 3232	142
OP 1580	83	OS 2103	139	OS 3105	111	OS 3233	142
OP 1628	71	OS 2104	139	OS 3106	111	OS 3234	142
OP 2003	272-273	OS 2105	139	OS 3107	111	OS 3235	142
OP 3221	273	OS 2106	139	OS 3108	111	OS 3236	142
OP 3231	272	OS 2107	139	OS 3109	111	OS 3237	142
OP 3501	92-340	OS 2199	139	OS 3110	111	OS 3238	142
OP 3510	92-340	OS 3000	114	OS 3111	111	OS 3239	142
OP 3520	92-340	OS 3001	111	OS 3112	111	OS 3240	142
OP 4505	255	OS 3002	111	OS 3113	111	OS 3241	142
OP 5060	90-366	OS 3003	111	OS 3114	111	OS 3242	142
OP 5061	90-366	OS 3004	111	OS 3115	111	OS 3243	142
OP 6103	61	OS 3005	111	OS 3116	111	OS 3244	142
OP 6150	61	OS 3006	111	OS 3117	111	OS 3245	142
OP 6223	61	OS 3007	111	OS 3118	111	OS 3246	142
OP 6252	61	OS 3008	111	OS 3119	111	OS 3247	142
OP 6270	60	OS 3009	111	OS 3130	113	OS 3248	142
OP 6500	60	OS 3010	111	OS 3131	111	OS 3249	142
OP 6510	60	OS 3011	111	OS 3132	111	OS 3250	109
OP 6555	59	OS 3012	111	OS 3133	111	OS 3251	142
OP 6750	59	OS 3013	111	OS 3134	111	OS 3252	142
OP 6813	59-60	OS 3014	111	OS 3135	111	OS 3253	142
OP 6814	61	OS 3015	111	OS 3136	111	OS 3254	108-142-144
OP 6850	58	OS 3016	111	OS 3137	111	OS 3255	108-142-144
OP 6856	58	OS 3017	111	OS 3138	111	OS 3256	108
OP 6910	60	OS 3018	111	OS 3139	111	OS 3258	107
OP 7811	59	OS 3019	114	OS 3140	111	OS 3259	107
OP 9210	220	OS 3020	114	OS 3141	111	OS 3260	107
OS 0080	101	OS 3021	114	OS 3142	111	OS 3261	107
OS 1000	136	OS 3022	114	OS 3143	111	OS 3262	107
OS 1001	136	OS 3023	114	OS 3200	108	OS 3263	107
OS 1002	136	OS 3024	114	OS 3201	107	OS 3264	107
OS 1003	136	OS 3025	114	OS 3202	107	OS 3265	107
OS 1004	136	OS 3031	111	OS 3203	107	OS 3266	107
OS 1005	136	OS 3032	111	OS 3204	107	OS 3267	107
OS 1006	136	OS 3033	111	OS 3205	107	OS 3268	107
OS 1007	136	OS 3034	111	OS 3206	107	OS 3269	107
OS 1008	136	OS 3035	111	OS 3207	107	OS 3300	110
OS 1010	141	OS 3036	111	OS 3208	107	OS 3301	110
OS 1099	136	OS 3037	111	OS 3209	107	OS 3302	110
OS 1100	137	OS 3038	111	OS 3210	107	OS 3303	110
OS 1101	137	OS 3039	111	OS 3211	108	OS 3304	110
OS 1102	137	OS 3050	112	OS 3212	108	OS 3305	110
OS 1103	137	OS 3051	112	OS 3213	108	OS 3306	110
OS 1104	137	OS 3052	112	OS 3214	108	OS 3307	110
OS 1105	137	OS 3055	116	OS 3215	108	OS 3308	110
OS 1106	137	OS 3088	116	OS 3216	108	OS 3400	122
OS 1107	137	OS 3089	116	OS 3217	108	OS 3401	121

REF	PAGE	REF	PAGE	REF	PAGE	REF	PAGE
OS 3402	121	OS 3519	124	OS 4029	130	OS 5204	134
OS 3403	121	OS 3520	124	OS 4030	130	OS 6000	143
OS 3404	121	OS 3521	124	OS 4031	130	OS 6001	143
OS 3405	121	OS 3522	126	OS 4032	130	OS 6002	142
OS 3406	121	OS 3523	126	OS 4100	129	OS 6003	142
OS 3407	121	OS 3524	126	OS 4101	116-129	OS 6004	142
OS 3408	121	OS 3525	126	OS 4102	116-129	OS 6005	142
OS 3411	121	OS 3530	125	OS 4103	116-129	OS 6006	142
OS 3412	121	OS 3531	124	OS 4104	116-129	OS 6007	142
OS 3413	121	OS 3532	124	OS 4105	116-129	OS 6008	142
OS 3414	121	OS 3533	124	OS 4106	116-129	OS 6009	142
OS 3415	121	OS 3534	124	OS 4107	116-129	OS 6010	142
OS 3416	121	OS 3535	124	OS 4108	116-129	OS 6011	142
OS 3417	121	OS 3536	124	OS 4109	116-129	OS 6012	142
OS 3418	121	OS 3537	124	OS 4110	116-129	OS 6013	142
OS 3419	121	OS 3538	124	OS 4111	116-129	OS 6014	142
OS 3420	121	OS 3539	124	OS 4112	116-129	OS 6015	142
OS 3426	123	OS 3550	126	OS 4113	116-129	OS 6016	142
OS 3430	122	OS 3551	124	OS 4114	116-129	OS 6017	142
OS 3431	121	OS 3552	124	OS 4115	116-129	OS 6018	142
OS 3432	121	OS 3553	124	OS 4116	116-129	OS 6019	142
OS 3433	121	OS 3554	124	OS 4117	116-129	OS 6020	142
OS 3434	121	OS 3555	124	OS 4200	129	OS 6021	142
OS 3435	121	OS 3556	124	OS 4201	116-129	OS 6022	142
OS 3436	121	OS 3557	124	OS 4202	116-129	OS 6023	142
OS 3437	121	OS 3558	124	OS 4203	116-129	OS 6024	142
OS 3438	121	OS 3559	126	OS 4204	116-129	OS 6025	142
OS 3450	123	OS 3560	126	OS 4301	131	OS 6026	142
OS 3451	121	OS 3561	126	OS 4302	131	OS 6027	142
OS 3452	121	OS 3562	126	OS 4303	131	OS 6028	142
OS 3453	121	OS 3600	110	OS 4304	131	OS 6029	142
OS 3454	121	OS 3601	110	OS 4305	131	OS 6030	142
OS 3455	121	OS 3602	110	OS 4306	131	OS 6031	142
OS 3456	121	OS 3603	110	OS 4307	131	OS 6032	142
OS 3457	121	OS 3604	110	OS 4308	131	OS 6033	142
OS 3458	121	OS 3605	110	OS 4309	131	OS 6034	142
OS 3459	121	OS 3606	110	OS 4310	131	OS 6035	142
OS 3460	121	OS 3607	110	OS 4311	131	OS 6036	142
OS 3461	123	OS 3608	110	OS 4312	131	OS 6037	142
OS 3462	123	OS 3609	110	OS 4399	131	OS 6038	142
OS 3463	123	OS 3610	110	OS 4401	131	OS 6039	142
OS 3464	123	OS 3611	110	OS 4402	131	OS 6040	142
OS 3500	125	OS 3612	110	OS 4403	131	OS 6041	142
OS 3501	124	OS 3613	110	OS 4404	131	OS 6042	142
OS 3502	124	OS 3614	110	OS 4405	131	OS 6043	143
OS 3503	124	OS 3615	110	OS 4499	131	SA 0045	177-350
OS 3504	124	OS 3616	110	OS 5000	132	SA 0108	42
OS 3505	124	OS 3617	110	OS 5001	132	SA 0109	42
OS 3506	124	OS 3618	110	OS 5002	132	SA 0114	346
OS 3507	124	OS 3619	110	OS 5003	132	SA 0115	308-349
OS 3508	124	OS 3620	109-110	OS 5004	132	SA 0231	326
OS 3509	124	OS 4020	130	OS 5005	133	SA 0232	326
OS 3511	124	OS 4021	130	OS 5014	133	SA 0233	326
OS 3512	124	OS 4022	130	OS 5024	133	SA 0235	326
OS 3513	124	OS 4023	130	OS 5099	132	SA 0236	326
OS 3514	124	OS 4024	130	OS 5105	135	SA 0237	326
OS 3515	124	OS 4025	130	OS 5200	134	SA 0238	327
OS 3516	124	OS 4026	130	OS 5201	134	SA 0239	327
OS 3517	124	OS 4027	130	OS 5202	134	SA 0240	327
OS 3518	124	OS 4028	130	OS 5203	134	SA 0241	327

INDEX • ALPHANUMERICAL

REF	PAGE	REF	PAGE	REF	PAGE	REF	PAGE
SA 0245	327	SA 0320	117	SA 0397	117	SA 0497	111
SA 0247	327	SA 0321	117	SA 0398	117	SA 0498	111
SA 0248	327	SA 0322	117	SA 0399	117	SA 0499	111
SA 0249	327	SA 0323	117	SA 0403	117	SA 0604	115
SA 0261	117	SA 0324	117	SA 0404	117	SA 0605	115
SA 0262	117	SA 0325	117	SA 0408	117	SA 0606	115
SA 0264	117	SA 0343	117	SA 0411	183	SA 0611	183
SA 0265	117	SA 0344	117	SA 0416	117	SA 0618	224
SA 0266	117	SA 0345	117	SA 0417	117	SA 0619	224
SA 0267	117	SA 0346	117	SA 0422	117	SA 0624	271
SA 0268	117	SA 0347	117	SA 0432	107	SA 0625	271
SA 0269	117	SA 0348	117	SA 0433	107	SA 0626	271
SA 0271	117	SA 0349	117	SA 0436	117	SA 0627	271
SA 0272	117	SA 0350	117	SA 0437	117	SA 0628	224
SA 0273	117	SA 0351	117	SA 0446	177-350	SA 0629	224
SA 0274	117	SA 0352	117	SA 0447	327	SA 0636	171
SA 0275	117	SA 0353	117	SA 0449	327	SA 0637	171
SA 0276	117	SA 0354	117	SA 0450	117	SA 0638	224
SA 0277	117	SA 0355	307	SA 0451	117	SA 0639	224
SA 0278	117	SA 0356	117	SA 0452	117	SA 0767	127
SA 0279	117	SA 0357	117	SA 0453	117	SA 0768	127
SA 0280	117	SA 0358	117	SA 0454	117	SA 0769	127
SA 0281	117	SA 0359	117	SA 0455	117	SA 0770	127
SA 0282	117	SA 0360	117	SA 0456	117	SA 0801	342
SA 0283	117	SA 0361	117	SA 0457	117	SA 0803	342
SA 0284	117	SA 0362	117	SA 0458	117	SA 0804	342
SA 0285	117	SA 0363	117	SA 0459	107	SA 0805	342
SA 0286	117	SA 0364	117	SA 0460	107	SA 0806	342
SA 0287	117	SA 0365	117	SA 0461	107	SA 0807	342
SA 0288	117	SA 0366	117	SA 0462	107	SA 0808	342
SA 0289	117	SA 0367	117	SA 0463	107	SA 0816	57
SA 0290	117	SA 0368	117	SA 0464	107	SA 0817	57
SA 0291	117	SA 0369	117	SA 0465	107	SA 0818	57
SA 0292	117	SA 0370	117	SA 0466	117	SA 0819	57
SA 0293	117	SA 0371	117	SA 0467	117	SA 0832	57
SA 0294	117	SA 0372	117	SA 0468	117	SA 0838	57
SA 0295	117	SA 0373	117	SA 0470	121	SA 0901	56
SA 0296	117	SA 0374	117	SA 0471	121	SA 1002	246
SA 0297	117	SA 0375	117	SA 0472	121	SA 1070	145-349
SA 0298	117	SA 0376	117	SA 0473	121	SA 1073	145-349
SA 0299	117	SA 0377	117	SA 0474	121	SA 1092	248
SA 0300	117	SA 0378	117	SA 0475	121	SA 1203	86
SA 0301	117	SA 0379	117	SA 0476	117	SA 1209	85-331
SA 0302	117	SA 0380	117	SA 0477	117	SA 1210	85-331
SA 0303	117	SA 0381	117	SA 0478	117	SA 1211	85-331
SA 0304	117	SA 0382	117	SA 0479	117	SA 1212	85-331
SA 0306	117	SA 0383	117	SA 0480	117	SA 1213	85
SA 0307	117	SA 0384	117	SA 0481	117	SA 1250	87-88-337
SA 0308	117	SA 0385	117	SA 0482	117	SA 1312	92-339
SA 0309	117	SA 0386	117	SA 0483	117	SA 1314	92-339
SA 0310	117	SA 0387	117	SA 0484	117	SA 1316	92-339
SA 0311	117	SA 0388	117	SA 0488	111	SA 1320	92-339
SA 0312	117	SA 0389	117	SA 0489	111	SA 1421	86
SA 0313	117	SA 0390	117	SA 0490	111	SA 1429	89
SA 0314	117	SA 0391	117	SA 0491	111	SA 1445	88
SA 0315	117	SA 0392	117	SA 0492	111	SA 1446	88
SA 0316	117	SA 0393	117	SA 0493	111	SA 1460	81-328
SA 0317	117	SA 0394	117	SA 0494	111	SA 1464	328
SA 0318	117	SA 0395	117	SA 0495	111	SA 1470	83-331
SA 0319	117	SA 0396	117	SA 0496	111	SA 1471	83-331

REF	PAGE	REF	PAGE	REF	PAGE
SA 2071	322	SA 6032	353	SA 9221	45
SA 2072	322	SA 6033	353	SA 9280	14-15
SA 2074	322	SA 6036	353	SA 9289	280
SA 2311	144	SA 6037	353	SA 9290	280
SA 2312	142	SA 6039	373	SA 9291	280
SA 2316	142	SA 6048	374	SA 9292	280
SA 2317	142	SA 6049	374	SA 9382	277
SA 2318	142	SA 6050	374		
SA 2319	142	SA 6051	374		
SA 2320	142	SA 6052	374		
SA 2324	142	SA 6053	374		
SA 2325	142	SA 6206	76		
SA 2326	142	SA 6474BL	313		
SA 2327	142	SA 6500	247		
SA 2328	142	SA 6615	332		
SA 2331	142	SA 6616	93-332		
SA 2334	142	SA 6805	357		
SA 2335	142	SA 6806	357		
SA 2339	142	SA 7009	117		
SA 2340	142	SA 7012	117		
SA 2341	142	SA 7013	117		
SA 2346	142	SA 7019	117		
SA 2347	142	SA 7023	117		
SA 2352	117	SA 7024	117		
SA 2353	142	SA 7025	117		
SA 2355	142	SA 7026	117		
SA 2356	142	SA 7061	322		
SA 2357	142	SA 7070	181-214-351		
SA 2358	142	SA 7080	111		
SA 2359	142	SA 7081	111		
SA 2605	79	SA 7082	111		
SA 3013	214	SA 7083	111		
SA 3200	184	SA 7084	111		
SA 3205	42	SA 7085	111		
SA 3217	185	SA 7086	107		
SA 3219	186	SA 7087	107		
SA 3222	185	SA 7088	107		
SA 3223	185	SA 7089	107		
SA 3231	185	SA 7090	107		
SA 3232	186	SA 7091	107		
SA 3233	185	SA 8001	344		
SA 3521	181	SA 8113	257		
SA 4023	218	SA 8305	314		
SA 4026	218	SA 8366	314		
SA 4027	218	SA 8404	313-314		
SA 4104	358	SA 8466	314		
SA 5025	115	SA 8989	247		
SA 5027	115	SA 9003	14-15		
SA 5029	115	SA 9004	14-15		
SA 5031	115	SA 9021	14		
SA 5032	115	SA 9022	14		
SA 5038	212	SA 9023	15		
SA 5240	215	SA 9026	218		
SA 5242	215	SA 9042	14		
SA 5244	240	SA 9043	14		
SA 5245	240	SA 9131	158		
SA 5281	215	SA 9132	158		
SA 5323	259	SA 9205	284		
SA 5503	228	SA 9206	284		
SA 6022	180-353	SA 9207	284		

INDEX • THEMATIC

2 COLUMNS LIFT			
2 COLUMNS ASYMETRIC POST LIFT 4T COMFORT LIFT		316	
4 COLUMN MOBILE LIFT			
4 MOBILE HGV LIFT COLUMNS 5.5T RG5.5-4 WIRE CONNECTION		317	
6 COLUMN MOBILE LIFT			
6 MOBILE HGV LIFT COLUMNS WIRE CONNECTION		318	
ABRASIVE			
150 ABRASIVE DISC SET Ø50mm		329	
50 ABRASIVE DISCS Ø50mm		329-86	
ABS			
ABS SEALANT INSTALLATION TOOL VOLVO/RENAULT		261	
ABS SEALANT			
ABS SEALANT INSTALLATION TOOL VOLVO/RENAULT		261	
ABSORBER			
CABIN SHOCK ABSORBERS ASSEMBLY/DISASSEMBLY PACK		204	
ADAPTER			
CALIBRATION PUMP ADAPTER M31x100		214	
INJECTOR ADAPTER M18x150		217	
ADAPTOR			
BIT HOLDER ADAPTOR 1/4" FOR SCREWERS		108-142-144	
HEX MALE ADAPTOR 1/4"-1/4"SQUARE L.25mm		108-142-144	
ADBLUE			
ROTARY PUMP SUITABLE FOR ADBLUE		170-193	
ADBLUE + LOW PRESSURE GAUGE SET		192	
ROTARY PUMP SUITABLE FOR ADBLUE		170-193	
ADDITIVE			
DIESEL INJECTOR CLEANER 300ml		224	
PETROL INJECTOR CLEANER 300ml		224	
ADHESIVE			
SCREEN ADHESIVE CARTRIDGE 290ml		365	
ADHESIVE TAPE			
ADHESIVE SIGNALING AND SAFETY VINYL TAPE 33m W.50mm		28	
ADJUSTABLE JOINT			
4 PCS PLIER INSERT		132	
4 PLIERS SET		132	
ADJUSTABLE JOINT L.250mm		132	
ADJUSTMENT			
CAST IRON SURFACE PLATE FOR CHECKING HEAD FLATNESS		230-53	
AIR BLASTER			
12I ALUMINUM AIR BLASTER/BAZOOKA		306	
19I TIRE BEAD BLASTER CAR/LCV/HGV		306	
AIR COMPRESSOR			
AIR COMPRESSOR 100I 3CV SINGLE-PHASE		61	
AIR COMPRESSOR 200I 3CV SINGLE-PHASE		61	
AIR COMPRESSOR 50I 2CV SINGLE-PHASE		61	
BELT COMPRESSOR SLOW SPEED 270I 5.5CV		60	
BELT COMPRESSOR SLOW SPEED 500I 10CV		60	
BELT COMPRESSOR SLOW SPEED 500I 7.5CV		60	
LOW NOISE BELT COMPRESSOR SLOW SPEED 7CV		59	
MONOPHASE AIR COMPRESSOR 150I 3CV		61	
PAINTED VERTICAL TANK 500I 11bar		58	
PAINTED VERTICAL TANK 500I 16bar		58	
RECIPROCATING COMPRESSOR HOUSING SLOW MOVING 10CV		59	
SCREW COMPRESSOR SOUNDPROOFED 20CV		59	
AIR CONDITION			
12 SYRINGE TRACER PACK 7,5ml FOR HYBRID VEHICLE		246	
12 SYRINGE TRACER PACK 7,5ml FOR R1234 GAS		246	
12 SYRINGE TRACER PACK 7,5ml FOR R134 GAS		246	
HYBRID VEHICLES AIR CONDITION TRACER BOTTLE 250ml		247	
PAIR OF ULTRANITRIL GLOVES FOR AIR CONDITIONING MAINTENANCE IN388 EN374		247	
UNIVERSAL AIR CONDITION TRACER BOTTLE 250ml		247	
AIR CONDITION LEAK			
AIR CONDITION R1234 YF CONTROL SET BY TRACER		246	
AIR CONDITION R134 CONTROL SET BY TRACER		246	
AIR CONDITIONING			
AIR CONDITIONING WASHING KIT		250	
NITROGEN/HYDROGEN LEAK KIT (N2-H2) 50bars		248	
UNIVERSAL ELECTRONIC LEAK DETECTOR R134/I234YF/HYDROGEN		248	
AIR CONDITIONING DETECTION IMPURITIES			
DETECTION KIT / AIR CONDITIONING IMPURITIES FILTRATION SYSTEM R1234YF		249	
DETECTION KIT / AIR CONDITIONING IMPURITIES FILTRATION SYSTEM R134		249	
AIR CONDITIONING LEAK			
AIR CONDITIONING LEAK STOP 30g		247	
NITROGEN/HYDROGEN LEAK KIT (N2-H2) 50bars		248	
UNIVERSAL ELECTRONIC LEAK DETECTOR R134/I234YF/HYDROGEN		248	
AIR CONDITIONING MAINTENANCE R1234YF			
AIR CONDITIONING MAINTENANCE KIT R1234YF		251	
AIR CONDITIONING WASHING			
AIR CONDITIONING WASHING KIT		250	
AIR HYDRAULIC JACK			
AIR HYDRAULIC JACK 15-30T		163	
AIR PUMP			
AIR HYDRAULIC PUMP 10T 1/4"		343	
AIR REEL			
AIR REEL Ø10mm 16m		71	
METAL CASE REEL Ø8mm		69	
AIR SPRAY GUN			
STRAIGHT BLOWGUN PEN		340-69-76	
VARIABLE BLOWGUN BLUE METALLIC NOZZLE		69-76	
AIR-CONDITIONING			
SPECIAL A/C JOINT SET		251	
AIRBAG			
12 PCS AIRBAG MAINTENANCE TOOL SET		347	
AIRBAG LINE TEST		347	
AIRCON			
AIRCON PERCEPTIBLE CLEANER 150ml		249	
VALVE/CONNECTOR/PLUG AIRCON MAINTENANCE SET		251	
ALEN			
SPHERICAL HEX KEY H2		140	
ALIGNMENT			
CLUTCH ASSEMBLY/DISASSEMBLY SET		232	
HGV CLUTCH ALIGNMENT TOOL		232	
ALLEN			
7 PCS HEX T-HANDLE WRENCH SET 3-10mm		138	
9 PCS SPHERICAL HEX KEY SET H1,5-10		108-140	
SPHERICAL HEX KEY		140	
ALTERNATOR PULLEY DISMANTLING			
30PCS FREEWHEELING ALTERNATOR PULLEY DISMANTLING KIT		213	
ALTERNATOR TESTER			
12V BATTERY TESTER & 12/24V ALTERNATOR		240	
PRINTER		240	
ALU RIM			
4 IMPACT SOCKET 1/2" KIT FOR ALU RIMS		115	
ALU WHEEL RIM			
3 IMPACT SOCKET KIT FOR ALU RIMS		115	
5 ALU WHEEL RIM 1/2" IMPACT SOCKET SET		115-286	
ALUMINUM AIR PIPE			
ALUMINUM AIR PIPE AND FITTING KIT Ø16mm L.20M 3 DOWNPIPES		63	
ALUMINUM AIR PIPE AND FITTING KIT Ø20mm L.30M 4 DOWNPIPES		63	

ALUMINUM AIR PIPE AND FITTING KIT Ø25mm L.36M 5 DOWNPIPES	63
ALUMINUM AIR PIPE AND FITTING KIT Ø32mm L.60M 8 DOWNPIPES	62
ALUMINUM PIPE	
ALUMINUM PIPE Ø16mm LENGTH 4M	65
ALUMINUM PIPE Ø20mm LENGTH 4M	65
ALUMINUM PIPE Ø25mm LENGTH 4M	65
ALUMINUM PIPE Ø32mm LENGTH 4m	65
ALUMINUM PIPE Ø40mm LENGTH 4M	65
AMMETER CLAMP	
AMMETER CLAMP 1000A	23
ANGLE DRILL	
Ø10mm REVERSIBLE ANGLE-DRILL	81
ANGULAR TORQUE WRENCH	
1/2" D. ANGLE WRENCH WITH MAGNETIZED ARM	128
ANTI GRAVEL	
ANTI GRAVEL MS POLYMER BLACK CARTRIDGE 310ml	333
ANTI REBOUND	
ANTI-REBOUND HAMMER 4.5kg L.900mm	146-287
ANTI STONE-CHIP	
ANTI STONE-CHIP SPRAY 400ml	334
ASPIRADOR	
SPIRAL 4000mm Ø42mm	177-350
ATOLMISER	
AIR CONDITION TRACER SPRAY CLEANER 400ml	249
AUGMENTER	
1/2"D.x3/4" D. AUGMENTER	121
AUTO DENT REPAIR	
AUTO DENT REPAIR KIT WITH SLIDE HAMMER	345
AUTO TORQUING	
TIE-ROD ASSEMBLER/REMOVER Ø30-Ø45mm WITH INTERCHANGEABLE HEADS 4PCS	268
AUTO TORQUING PLIERS	
VICE GRIP 200mm	260
AXLE	
4 PIN REAR AXLE SOCKET SCANIA Ø91mm	295
6 PIN FRONT HUB SOCKET MAN Ø92,5mm	289
ABRASIVE HOLDER DISC TRAY SUPPORT AXLE Ø50mm	329-86
HYDRAULIC PULLER FRONT AXLE SPACER MERCEDES/MAN	269
AXLE SOCKET	
4 PIN REAR AXLE SOCKET SCANIA Ø91mm	295
6 PIN FRONT HUB SOCKET MAN Ø92,5mm	289
AXLES	
WHEEL CAPSULE AND AXLE NUT SOCKET 65mm 3/4"	298
BAG	
CARTRIDGE AND BAGS GUN 340mm 12:1	366-90
BALANCER	
MOTORIZED WHEEL BALANCER WITH DIGITAL DISPLAY	312
BALL JOINT	
10T UNIVERSAL BALL JOINT/SILENT-BLOCK REMOVER	267
BALL JOINT PULLER Ø35mm	267
BALL JOINT SEPARATOR Ø18mm	266
HYDRAULIC BALL JOINT PULLER KIT Ø30-34-40mm	266
INJECTOR ADAPTER M18x150	217
LOWER BALL JOINT HEX SOCKET PSA 41mm 1/2" D.	116
UPPER/LOWER HUB RENAULT/OPEL EXTRACTION RING SET	277
BALL JOINT PULLER	
BALL JOINT PULLER Ø35mm	267
BALL JOINTS	
3 BALL JOINT PULLER SET Ø23 TO Ø34mm	266
BANNER	
SIGNAGE BANNER "WORK ZONE BOUNDARY" 100x20cm	28

BAR	
1" SLIDING T-HANDLE	126
1" SLIDING T-HANDLE L.550mm	126
1/4" SLIDING T HANDLE	108
3/4" SLIDING T-HANDLE L.500mm	123
BASE	
COMPARATOR+MAGNETIC BASE PACK	231-252-52
MAGNETIC BASE FOR COMPARATORS	52
UNIVERSAL 20-30T PRESS SUPPORT STRUCTURE	152
BATTERY	
12/24V BATTERY ELECTRICAL SYSTEM TESTER & 12/24V ALTERNATOR WITH DETACHABLE PRINTER	240
12V BATTERY TESTER	241
4.0Ah LI-ION BATTERY	79
HGV BATTERY CRANE	209-242
BATTERY TESTER	
12/24V BATTERY ELECTRICAL SYSTEM TESTER & 12/24V ALTERNATOR WITH DETACHABLE PRINTER	240
12V BATTERY TESTER & 12/24V ALTERNATOR	240
PRINTER	240
BAZOOKA	
12l ALUMINUM AIR BLASTER/BAZOOKA	306
BEAD BREAKER	
HYDROPNEUMATIC BEAD BREAKER + PUMP/HOSE/CONNECTOR	307
BEAD KEEPER FOR WHEEL RIM	
HGV BEAD KEEPER FOR ALUMINUM WHEEL RIM	306
BEARING	
11 BALL BEARING EXTRACTOR FOR ZF AS TRONIC GEARBOX	237
3 BEARING MOUNTING TUBES FOR ZF16 ECOSPLIT GEARBOX	236
3/4" ROLLER BEARING AXLE NUT SOCKET BPW 12T 80mm	296
3/4" ROLLER BEARING AXLE NUT SOCKET BPW 16T HEX	297
3/4" ROLLER BEARING AXLE NUT SOCKET BPW 6.5/9T 65mm	296
BEARING EXTRACTOR SET INTERNAL GRIP Ø8-Ø32mm	283
BEARING EXTRACTOR SET INTERNAL GRIP Ø8-Ø58mm	283
BEARING FORK SEAL INSTALLATION/EXTRACTION KIT	152
BEARING INSTALLATION/EXTRACTION KIT	282
BEARING PULLER FOR GEARBOXES ZF SET	237
BEARING EXTRACTOR	
11 BALL BEARING EXTRACTOR FOR ZF AS TRONIC GEARBOX	237
BEARING GEARBOX	
ZF16 GEARBOX BEARING PULLER	235
BEARING PULLER	
BEARING AND GEARWHEEL PULLER FOR ZF16 221-251 GEARBOX	236
ZF16 GEARBOX BEARING PULLER	235
BELT	
IVECO AIR-CONDITIONING ELASTIC BELT MOUNTING TOOL	207
BENCH GRINDER	
900W INDUSTRIAL BENCH GRINDER Ø200x32x32mm WHEEL+BRUSH	41
BENCH GRINDER BRUSH	41
VITRIFIED GRINDING WHEEL GREY CORUNDUM 200x32x32mm GRIT 60	41
BEVELLED BLADE	
10 PCS BEVELLED BLADE SET 16mm	355
BI-COMPOSING GUN	
BI-COMPOSING GUN 50ml	374-91
BIQUE	
1T LOW PROFILE FOLDABLE CRANE	154
2T FOLDABLE CRANE	154
BIT	
1/2" D. TORX SOCKET BIT T40 L.140mm	117
100 PCS SCREW BIT SET	143
12 PCS PULLING END SET	346

INDEX • THEMATIC

13 PCS XZN TIP+TIP HOLDER 1/2" SET	120	BOLT HEATER	
23 PCS BIT SET TS-TORX-TORX PLUS 1/4"-3/8"	109	FLEXIBLE INDUCTION COIL	57
32 PCS SCREWDRIVER BIT 1/4" SET	108-143	INDUCTION HEATER	57
43 PCS SPECIAL BIT INSERT	143	RIGID INDUCTION COIL Ø19mm	57
5 BITS SET 1/4" SHORT	142	RIGID INDUCTION COIL Ø23mm	57
5 SCREWDRIVER BITS SET 1/4"	142	RIGID INDUCTION COIL Ø32mm	57
5 SCREWDRIVER SLOTTED SET 1/4"	142	RIGID INDUCTION COIL Ø38mm	57
94 D. SOCKET SET 1/4"-1/2"	112	ROUND INDUCTION PAD Ø50mm	57
BIT 10mm LONG H	142	BOOSTER	
BIT 10mm LONG T	142	BOOSTER 12-24V 6200A/3100A	243
BIT 10mm LONG TORX TAMPER	142	BOOSTER 12V 2500A	243
BIT 10mm LONG XZN	142	BOTTLE	
BIT 10mm SHORT H	142	300 ml ENGINE LEAK STOP	225
BIT 10mm SHORT TORX TAMPER	142	5L CONTAINER OF BRAKES CLEANER	182
BIT 10mm SHORT XZN M	142	AIR CONDITIONING LEAK STOP 30g	247
33 PRECISION SCREWDRIVER + BIT SET	141	HYBRID VEHICLES AIR CONDITION TRACER BOTTLE 250ml	247
BIT HOLDER		UNIVERSAL AIR CONDITION TRACER BOTTLE 250ml	247
BIT HOLDER 1/4" HEXAGONAL-1/4" SQUARE	143	UNIVERSAL AIR CONDITIONING LUBRICANT BOTTLE 1L PAG	247
BIT HOLDER 10mm HEXAGONAL-1/2" SQUARE	143	BOTTLE JACK	
BIT HOLDER ADAPTOR 1/4" FOR SCREWERS	108-142-144	BOTTLE JACK	157
BIT HOLDER 10mm HEXAGONAL-1/2" SQUARE	143	BOWL	
BIT HOLDER ADAPTOR 1/4" FOR SCREWERS	108-142-144	1.2l GRUATED TANK+CAP	353
BLADE		BOWL/SEAL/RING KIT FOR BALANCERS	313
10 PCS BLADE SET 12mm	355	MAGNETIC TRAY	100
10 PCS BREAKABLE BLADE SET	356-51	BOX	
10 PCS UNBREAKABLE BLADE SET	356-51	INSERT CASE FORMAT 1/3 DRAWER	101
6 PCS 25mm BLADE SET	360	METAL TOOLBOX 101 PCS	102
7 PCS 38mm BLADE SET	360	METAL TOOLBOX 3 STOREY/6 COMPARTMENT	95
PAIR OF SUCTION CUPS Ø120mm	365	BRAKE	
STRAIGHT BLADE	362	12 BRAKE BLEEDER PLUG SET	256
U-SHAPED BLADE 36mm	362	3/16" ADAPTER	259
BLEEDING		5 PLUG SET FOR BRAKE/CLUTCH BLEEDERS	258
DIESEL STARTING BLEEDING PNEUMATIC KIT	191	ASSORTED POPULAR BRAKE LINE FITTINGS BOX 135 PCS	260
BLOCK		BPW BRAKE LINKAGE ADJUSTER EXTRACTOR	253
BLOCK ANVIL 80x62x55mm	147	BRAKE & ABS PRESSURE GAUGE SET	252
BLOCK CLAW 78x60x27mm	147	BRAKE DISMOUNTING TOOL L.450mm-620mm	253
BLOCK COMMA 130x55mm	147	BRAKE FLUID TESTER PROBE	252
BLOCK RAIL/UNIVERSAL 60X60X56mm	147	BRAKE LINING PLIERS	254
HAMMER + BLOCK SET	147-341	BRAKE PLIERS HGV L.520mm OPENING 210mm	253
LV BLOCK	168	BRAKE SPRING TOOL	254
BLOWTORCH		DIN/SAE BRAKE LINE REPAIR KIT	259
MINI TORCH WITH RETRACTABLE TUBING	21	DRUM BRAKE PLIER IVECO/VOLVO WITH Z-CAM	253
BODYWORK		ELECTRIC BRAKE BLEEDER 5-20L 3.5bar	257
10T COLLISION REPAIR SET	342	ELECTRICAL BRAKE BLEEDER 30-60L 3.5bar	257
4T COLLISION REPAIR SET	342	HALDEX BRAKE LINKAGE ADJUSTER EXTRACTOR	253
6 BODYWORK SUCTION CUP SET Ø85mm	364	HANDBRAKE CABLE PLIER	254
ADJUSTABLE BODYWORK EASEL WITH TOOL HOLDER	363	HGV BRAKE PLIERS L.670mm OPENING 200mm	253
BODYWORK CYLINDER SET PUSHER/PULLER 1/4"	343	HGV MAN TGA PLUG SET	233
BODYWORK HOLDER	363	HGV MERCEDES PLUG SET	233
BODYWORK SUPPORT	324	MANUAL BRAKE LINE BENDER Ø3-Ø4-Ø6mm	260
PNEUMATIC GUN FOR 370mm CARTRIDGES AND BAGS	366-90	PNEUMATIC BRAKE AND CLUTCH BLEEDER	256
BODYWORK HYDRAULIC RAM		SPRING COMPRESSION TOOL	254
10T HYDRAULIC RAM	342	BRAKE BLEEDER	
4T HYDRAULIC RAM	342	2 BRAKE OIL RECOVERY JERRYCANS	257
BODYWORK PLIERS		5 PLUG SET FOR BRAKE/CLUTCH BLEEDERS	258
BODYWORK PLIERS	328	ELECTRIC BRAKE BLEEDER 5-20L 3.5bar	257
BODYWORK TROLLEY		ELECTRICAL BRAKE BLEEDER 30-60L 3.5bar	257
PARTS/WINDSCREEN/COVERS DOLLY	323	HGV MAN TGA PLUG SET	233
PIVOTING DOLLY WHEEL Ø148mm	322	HGV MERCEDES PLUG SET	233
TROLLEY BLOCKED UNDER CAR BODY	322	PNEUMATIC BRAKE AND CLUTCH BLEEDER	256
		PNEUMATIC VACUUM BRAKE BLEEDER	258

BRAKE CABLE	
BRAKE SPRING TOOL	254
BRAKE CLEANER	
5L CONTAINER OF BRAKES CLEANER	182
RECHARGEABLE SPRAY 650ml	178
BRAKE DEMOUNT	
BRAKE DISMOUNTING TOOL L.450mm-620mm	253
BRAKE DISC	
BRAKE DISC EXTRACTION JACKS	263
BRAKE FLUID	
BRAKE FLUID TESTER PROBE	252
BRAKE HOSE	
BRAKE HOSE RECTIFIER	260
BRAKE LINE	
10 PCS REPAIR TOOL SAE MALE/FEMALE SET	259
BRAKE LINING	
BRAKE LINING PLIERS	254
SPRING COMPRESSION TOOL	254
BRAKE PLIERS	
DRUM BRAKE PLIER IVECO/VOLVO WITH Z-CAM	253
BRAKE PLUG	
12 BRAKE BLEEDER PLUG SET	256
BRAKE PULLER	
BPW BRAKE LINKAGE ADJUSTER EXTRACTOR	253
HALDEX BRAKE LINKAGE ADJUSTER EXTRACTOR	253
BRASS	
EXTRA LONG BRASS DRIFT 250X20mm	149
BRUSH	
10 PCS Ø18mm BRASS BRUSHES SET	224
10 PCS Ø18mm METAL BRUSH SET	224
10 PCS Ø18mm NYLON BRUSH SET	224
10 PCS Ø19mm BRASS BRUSHES SET	224
10 PCS Ø19mm METAL BRUSH SET	224
10 PCS Ø19mm NYLON BRUSH SET	224
7 PCS STUD CLEANING KIT	285
BORE BRUSH SET	224
METAL BRUSH L.23mm	331-85
PACK BRUSHES+TRANSLUCENT TIRE MOUNTING CREAM 1kg	309
WIRE BRUSH	178-327
WIRE BRUSH (FINE) L.23mm	331-85
BRUSHER	
MULTI-SERVICE BRUSH	331-85
BTR	
7 PCS HEX T-HANDLE WRENCH SET 3-10mm	138
T-HANDLE WRENCH H7 x 160	138
BUMPER	
BUMPER STRUCTURING SPRAY MEDIUM GRIT 400ml	373
BYPASS	
GEARBOX OIL COOLER SUBSTITUTE DAF 105	210-234
GEARBOX OIL COOLER SUBSTITUTE DAF 95	210-234
CABLE	
SPRING LOCKING SECURITY SAWING CABLE L.450mm	274
CABLE BUNDLE	
MINI TORCH WITH RETRACTABLE TUBING + GAS REFILL	21
CALIBRATION	
CALIBRATION PUMP ADAPTER M31x100	214
CALIBRATION INJECTOR	
600bar PUMP FOR INJECTOR CALIBRATION	214
CALIBRATION PUMP	
CALIBRATION PUMP ADAPTER M31x100	214
CALIPER	
RIM WIDTH CALIPER	314
CALIPER BASE	
CALIPER BASE	231-53
CALIPER BASE Ø DISKS AND BRAKE DRUMS	252
DIGITAL CALIPER	231-53
CALIPER SUPPORT	
HGV BRAKE CALIPER SUPPORT	262
HGV HIGH ELEVATION BRAKE CALIPER SUPPORT	263
HUB/CALIPER AND BRAKE DRUMS HIGH ELEVATION SUPPORT	265
HUB/CALIPER AND BRAKE DRUMS SUPPORT	264
CAN	
DEGREASING/CLEANING PRODUCT FOR WASHERS 25L	181
OIL CAN 500ml	171-44
CANISTER WASHING AIR CONDITIONING	
LIQUID CANISTER WASHING AIR CONDITIONING 5L	250
CAP	
4 INSULATION CAPS Ø10mm L.60mm	27
4 INSULATION CAPS Ø15mm L.100mm	27
4 INSULATION CAPS Ø20mm L.120mm	27
CAP	64
IVECO OIL FILTER WRENCH SET	196
CAR RADIO	
CAR-RADIO REMOVAL TOOL KIT	20-347
CARBIDE BIT	
CARBIDE BIT Ø1mm	358
CARTRIDGE	
BLACK SEALANT CARTRIDGE -40/+250 DEGREES 200ml	225-49
CARTRIDGE AND BAGS GUN 340mm 12:1	366-90
GLUE AND WHITE MASTIC CARTRIDGE 310ml	334-49
SCREEN ADHESIVE CARTRIDGE 290ml	365
CASING REPAIR	
OIL SUMP REPAIR KIT WITH PLUGS	197
CENTERING CONE	
3 CENTERING CONE SET INTENSIVE USE Ø40-98mm Ø40mm	314
LCV CENTERING CONE Ø118-174mm+SPACER DISK Ø40mm KIT	314
CENTERING FLANGE	
UNIVERSAL CYLINDRICAL QUICK FLANGE Ø40mm WITH 5 CENTE-RING RINGS	314
CENTRAL VACUUM	
CENTRAL VACUUM CLEANER 2x1300W	335
CHAIN	
PLASTIC SIGNALING CHAIN YELLOW/BLACK 25m	28
CHAMFERING TOOL	
CHAMFERING TOOL Ø16mm TO Ø50mm	65
CHARGING BASE	
CHARGING BASE	12
CHIPPING HAMMER	
PNEUMATIC CHISEL TOOLS	219-269-83
VIBRO CHISEL SET	83
CHISEL	
EXTRA FLAT SPLITTING CHISEL	149-341
FLAT CHISEL	149
PNEUMATIC CHISEL TOOLS	219-269-83
VIBRO CHISEL SET	83
CILINDER	
GO-THROUGH MECHADRAULIC CYLINDER 12T+ADAPTERS	279
CIRCLIP	
2 PCS HGV CIRCLIP SET (INTERIOR-EXTERIOR)	135
300 PCS 3-32mm EXTERNAL CIRCLIP SET	135-55
300 PCS E TYPE EXTERNAL CIRCLIP SET 1.5-22mm	135-55

INDEX • THEMATIC

300 PCS 3-32mm INTERNAL CIRCLIP SET	135-55		
INTERNAL/EXTERNAL CIRCLIP PLIERS	135		
CIRCLIP PLIER			
4PCS CIRCLIP PLIER INSERT 7" INSIDE-OUTSIDE	134		
CURVED PLIER EXTERNAL CIRCLIP 7"	134		
CURVED PLIER INNER CIRCLIP 7"	134		
STRAIGHT PLIER EXTERNAL CIRCLIP 7"	134		
STRAIGHT PLIER INNER CIRCLIP 7"	134		
INTERNAL/EXTERNAL CIRCLIP PLIERS	135		
CLAMP			
CLAMP 16mm	64		
FAST FUEL CONNECTORS CLAMP	189		
PISTON RING COMPRESSOR Ø65-135mm H.100mm	229		
PLIER FOR CLAMPS WITH DOUBLE GRIP	203		
UNIVERSAL CRIMPING PLIER FOR HGV	203		
CLAMP PLIERS			
PLIER FOR CLAMPS WITH DOUBLE GRIP	203		
CLAW			
HOOK KIT L.70 and 115mm	212		
CLAW WRENCH			
14" ALUMINUM CLAW WRENCH	133		
24" ALUMINUM CLAW WRENCH	133		
CLEANER			
1.7l PRESSURE SPRAYER BRAKE CLEANER	178		
AIR-CONDITIONING CIRCUIT CLEANER 400ml	249		
CLEANER/LUBRICANT SPRAY FOR PNEUMATIC TOOLS	78		
CLEANING			
1.5l BLUE PRESSURE SPRAYER	178-354		
1.5l RED PRESSURE SPRAYER	178-354		
7 PCS STUD CLEANING KIT	285		
AIRCON PERCEPTIBLE CLEANER 150ml	249		
BODY REPAIR DEGREASING/CLEANING SPRAY 500ml	182-338-346-47		
COMPLETE INJECTOR SEAT CLEANING KIT	223		
DIESEL INJECTOR CLEANER 300ml	224		
INJECTOR SEAT CLEANING KIT	223		
PETROL INJECTOR CLEANER 300ml	224		
PRESSURE FOAM SPRAYER 1l	179-352-94		
PRESSURE SPRAYER 1l	179-352-94		
CLEANING GUN			
CLEANING GUN	180-353-94		
CLEANING GUN EVOLUTION	180-353-94		
CLEANING SOLUTION	180-353		
CLEANSING			
5 230g MICROFIBERS SET 380x380mm	50		
80 CLEANSING MULTI PURPOSE WIPES	182-354-50		
90 CLEANSING WORKSHOP WIPES	182-308-50		
CLOTH			
5 230g MICROFIBERS SET 380x380mm	50		
CLUTCH			
CLUTCH ALIGNMENT TOOL	232		
CLUTCH ASSEMBLY/DISASSEMBLY SET	232		
ELECTRIC BRAKE BLEEDER 5-20L 3.5bar	257		
ELECTRICAL BRAKE BLEEDER 30-60L 3.5bar	257		
HGV CLUTCH ALIGNMENT TOOL	232		
MINERAL/MULTIGRADE OIL ELECTRIC CLUTCH BLEEDER 5-20L 3.5bar	233		
PNEUMATIC BRAKE AND CLUTCH BLEEDER	256		
CLUTCH AXIS			
CLUTCH AXIS EXTRACTOR FIAT/PSA	232		
CLUTCH BLEEDER			
MINERAL/MULTIGRADE OIL ELECTRIC CLUTCH BLEEDER 5-20L 3.5bar	233		
CO2 DETECTION			
CO2 DETECTION KIT	201-225		
CO2 DETECTION FLUID			
CO2 DETECTION FLUID	201-225		
COLLAR			
PISTON RING COMPRESSOR Ø90-175mm H.165mm	229		
COLLECTION			
2 BRAKE OIL RECOVERY JERRYCANS	257		
70L GREY WASTE OIL DRAINER	198		
80l MIXED WASTE OIL DRAINER	198		
80l MIXED WASTE OIL DRAINER WITH BOWL	198		
80l WASTE OIL DRAINER	198		
COLLECTION CONTAINER			
FLUID COLLECTION CONTAINER	169		
COLLECTOR			
65l HGV PIT COLLECTOR	199		
HGV FLUID COLLECTION CONTAINER 65l	199		
COLUMN			
HYDROPNEUMATIC MOBILE LIFTING COLUMN 1500kg	162-321		
COMBINATION PLIERS			
COMBINATION PLIERS L.180mm	132		
COMBINATION WRENCH			
1/2" COMBINATION WRENCH 3/8"	116		
1/2" COMBINATION WRENCH 5/16"	116		
12PCS ADJUSTABLE RATCHETING COMBINATION WRENCH INSERT 15° 8-19mm	130		
17 PCS COMBINATION WRENCH INSERT 6-24mm	129		
4 PCS COMBINATION WRENCH INSERT 27-32mm	129		
ADJUSTABLE RATCHETING COMBINATION WRENCH 15°	130		
COMBINATION WRENCH 1/2"	116		
COMBINATION WRENCH	116-129		
COMBINATION WRENCH 11/16"	116		
COMBINATION WRENCH 15/32"	116		
COMBINATION WRENCH 19/32"	116		
COMBINATION WRENCH 3/4"	116		
COMBINATION WRENCH 5/8"	116		
COMBINATION WRENCH 7/16"	116		
COMBINATION WRENCH 9/16"	116		
COMPARATOR			
50-160mm DRILLING INSPECTION DEVICE SET	231-53		
COMPARATOR WITH WORKING RANGE 0-10mm	52		
COMPARATOR+MAGNETIC BASE PACK	231-252-52		
MAGNETIC BASE FOR COMPARATORS	52		
COMPOSITE TAPPING FLANGE FOR PIPE			
COMPOSITE TAPPING FLANGE FOR PIPE	65		
COMPRESSION			
COMPRESSION MEASURING KIT FOR DIESEL ENGINES	227		
COMPRESSION GAUGE			
UNIVERSAL DUMMY INJECTOR	227		
COMPRESSION GAUGE DIESEL			
DIESEL COMPRESSION GAUGE	227		
COMPRESSOR			
PAIR OF SPRING COMPRESSORS	274		
REINFORCED PNEUMATIC SPRING COMPRESSOR WITH ARTICULATED JAWS	273		
SPECIAL SYNTHETIC OIL FOR SCREW COMPRESSORS (5L)	59-60		
SPECIALIST SYNTHETIC OIL FOR PISTON COMPRESSORS (2L)	61		
CONE			
CONE	353		

CONICAL SPRING CUP		GEARBOX OIL COOLER SUBSTITUTE DAF 95	210-234
CONICAL SPRING CUP	274		
CONNECTION		CRANKSHAFT	
CONNECTION DRAIN AND COOLING CIRCUIT FILLING SCANIA	202	17 CRANKSHAFT SEAL INSTALLATION CUPS	212
CONNECTOR		CRANKSHAFT SEAL	
24 CONNECTOR SET	215	CRANKSHAFT FRONT SEAL INSTALLATION TOOL DAF	210
4 COUPLING PUSH BUTTON SET	250	CRANKSHAFT FRONT SEAL INSTALLATION TOOL IVECO STRALIS 10L (F2C)	207
ASSORTED POPULAR BRAKE LINE FITTINGS BOX 135 PCS	260	CRANKSHAFT FRONT SEAL INSTALLATION TOOL IVECO/ASTRA 10-11-13-16L	207
CONNECTOR KIT FOR ELECTRICAL MEASURING TOOLS	23	CRANKSHAFT FRONT SEAL INSTALLATION TOOL SCANIA 12L Ø119	208
FEMALE CONNECTOR SCANIA VOLVO ZF	226	CRANKSHAFT FRONT SEAL INSTALLATION TOOL SCANIA Ø119-138mm	209
HYDRAULIC CONNECTION KIT IVECO	270	CRANKSHAFT FRONT SEAL INSTALLATION TOOL SCANIA Ø149mm	209
HYDRAULIC CONNECTION KIT MAN	270	CRANKSHAFT REAR SEAL INSTALLATION TOOL IVECO DAILY/FIAT DUCATO	207
HYDRAULIC CONNECTION KIT VOLVO/SCANIA/RENAULT	270	CRANKSHAFT REAR SEAL INSTALLATION TOOL IVECO EUROCAR-GO 1-3	207
HYDRAULIC FEMALE ADAPTER	342	CRANKSHAFT REAR SEAL INSTALLATION TOOL IVECO/ASTRA 10-13L	207
MALE CONNECTOR SCANIA VOLVO ZF	226	CRANKSHAFT REAR SEAL INSTALLATION TOOL SCANIA Ø175-185mm	208
MALE HYDRAULIC ADAPTER	342	CRANKSHAFT REAR SEAL INSTALLATION TOOL SCANIA Ø175mm	208
CONSUMABLE		CRANKSHAFT REAR SEAL INSTALLATION TOOL SCANIA Ø185mm	208
HOLLOW PUNCH SET Ø3-Ø16mm	148	CRANKSHAFT SEAL INSTALLATION RING SCANIA	208
CONTACT AGENT		CRANKSHAFT SEAL	
ELECTRIC SPRAY CLEANER 400ml	24	CRANKSHAFT FRONT SEAL INSTALLATION TOOL SCANIA 9-13L Ø119mm	209
CONTAINER		CREAM	
5L CONTAINER OF BRAKES CLEANER	182	TRANSLUCENT TIRE MOUNTING CREAM 1kg	309
65I HGV PIT COLLECTOR	199	CREEPER	
HGV FLUID COLLECTION CONTAINER 65I	199	6-WHEEL BUCKET-SEAT INSPECTION CREEPER	42
TUB OF ABRASIVE 1kg	357	CRIMPING PLIERS	
CONTAINMENT		PRO PLIERS FOR RIVETS & LOCKNUTS	375-82
SPILL CONTAINMENT TRAY	174	CROSS-HEADED	
SPILL CONTAINMENT TRAY 1100I	175	5 SCREWDRIVER BITS SET 1/4"	142
SPILL CONTAINMENT TRAY 1100L for 2xIBC	176	8 PCS SCREWDRIVER SET	136
SPILL CONTAINMENT TRAY 250I 2 DRUMS	175	PHILLIPS SCREWDRIVER 0x75	136
SPILL CONTAINMENT TRAY 480I 4 DRUMS	175	PHILLIPS SCREWDRIVER 2x125	136
CONTENT		CUP	
4 DRAWERS + 1 DOOR ROLLER CABINET HGV 197 TOOLS	106	BEARING FORK SEAL INSTALLATION/EXTRACTION KIT	152
7 DRAWERS ROLLER CABINET XL 228 TOOLS	105	CUP MEGANE 2 AND MERCEDES CLASS E	274
CONTENTS		CUP MERCEDES CLASSE C	274
METAL TOOLBOX 101 PCS	102	CUP PEUGEOT 206	274
CONTROL		CUPS RENAULT TWINGO III (2014)	274
STRAIGHT EDGE FOR CHECKING CYLINDER HEAD FLATNESS 400mm	230	GLASS COVER	14-15
STRAIGHT EDGE FOR CHECKING CYLINDER HEAD FLATNESS 600mm	230	HYDRAULIC PUMP WITH FRAME AND SPINDLES	277
CONTROL GAUGE		CUP BMW	
PIPE INSERTION CONTROL GAUGE Ø16mm TO Ø50mm	65	CUP BMW	274
COOLING		CUPS CITROEN C15	
COOLING LINE FILLING DEVICE	202	PAIR OF CUPS CITROEN C15 (REAR SHOCK-ABSORBER)	274
RADIATOR LEAK SEALER 300ml	201	CUPS Ø80/120mm	
COOLING CIRCUIT		2 CUPS Ø80/120mm	274
CONNECTION DRAIN AND COOLING CIRCUIT FILLING SCANIA	202	CUSHION	
COOLING LIQUID		INFLATABLE CUSHION	348
3L COOLING LIQUID	56	CUTTER	
COPPER CROWN		ANGLE CUTTER Ø75mm	84
COPPER CROWN Ø4.75mm L.7.62m	260	CENTRAL PLASMA CUTTING UNIT	326
CRANE		CONNECTABLE PLASMA CUTTER 40A	326
1T FOLDABLE CRANE	154	HAND CUTTER	360
1T LOW PROFILE FOLDABLE CRANE	154	CUTTER PLASMA	
2T FOLDABLE CRANE	154	BAG OF 2 DIFFUSERS	326
BUSES RADIATOR CRANE	200	CUTTING PLIERS	
HGV BATTERY CRANE	209-242	CUTTING PLIERS L.160mm	132
CRANE MOBILE			
MOBILE CRANE 1T	153		
CRANKCASE			
GEARBOX OIL COOLER SUBSTITUTE DAF 105	210-234		

INDEX • THEMATIC

CUTTING WIRE		PLANISHING HAMMER WITH ROUND FLAT HEAD AND POINTED TIP	147
CUTTING WIRE 0.7mmx0.7mmx44m	359	DESICCANT	
CV JOINT		METAL STRAP WRENCH FOR DESICCANT CARTRIDGE	191
1/2" D. HEX IMPACT UNIVERSAL JOINT SOCKET	111	DETECTION	
1/2" D. HEX IMPACT UNIVERSAL JOINT SOCKET SET	113	LPG DETECTION KIT	194
1/2" IMPACT SOCKET BIT SET HUB AND CV JOINT	116	DETECTION AIR CONDITIONING IMPURITIES FILTRATION R1234YF	
1/2" IMPACT WRENCH SET 13 PCS	79	DETECTION KIT / AIR CONDITIONING IMPURITIES FILTRATION SYSTEM R1234YF	249
10T HYDRAULIC DRIVE SHAFT PULLER SET	284	DETECTION AIR CONDITIONING IMPURITIES FILTRATION R134	
CV JOINT 1/2"	114	DETECTION KIT / AIR CONDITIONING IMPURITIES FILTRATION SYSTEM R134	249
CV JOINT 1/4"	108	DIESEL HEATER	
CV JOINT 3/8"	110	DIRECT DIESEL OIL EATER + EXCHANGER ANTARES 70	31
CV JOINT WRENCH DOUBLE HEX 1/2" D. 24mm VAG	116	DIRECT DIESEL OIL HEATER MIZAR P	34
CV JOINT PUSHER		DIRECT DIESEL OIL HEATER MIZAR P HANGING	34
10T HYDRAULIC DRIVE SHAFT PULLER SET	284	DIRECT DIESEL OIL HEATER MIZAR PX	33
CV JOINT SOCKET		DIESEL INJECTOR LINE SOCKET	
1/2" D. HEX IMPACT UNIVERSAL JOINT SOCKET SET	113	DIESEL INJECTOR LINE SOCKETS SET 1/2" DOUBLE HEX Ø12-14-16-17-18-19mm	216
CV JOINT WRENCH DOUBLE HEX 1/2" D. 24mm VAG	116	DIFFERENTIAL	
CYLINDER		HEXAGONAL SOCKET FOR MERCEDES/EVOBUS DIFFERENTIAL NUTS Ø72mm	290-293
50-160mm DRILLING INSPECTION DEVICE SET	231-53	MAN/MERCEDES DIFFERENTIAL REAR NUT 6 PIN SOCKET Ø113mm	290
CYLINDER LINER APPLICATION TOOL 60-160mm	228	DIFFUSER	
EXPANDING ENGINE CYLINDER HONE	228-254	BAG OF 2 DIFFUSERS	326
MOUNTING GUIDE CYLINDER SET VOLVO/RENAULT 11-12-13-16L	204-231	DISC SUPPORT	
UNIVERSAL CYLINDER LEAK DETECTOR TESTER	228	ABRASIVE HOLDER DISC TRAY SUPPORT AXLE Ø50mm	329-86
CYLINDER HEAD		DISC-SANDER	
IMPACT SOCKET E28 3/4" L 90mm CYLINDER HEAD FOR MAN/SCANIA	231	ANGLE GRINDER Ø125mm	330-84
CYLINDER SET PUSHER/PULLER		REVERSIBLE DISK-SANDER	330-84
BODYWORK CYLINDER SET PUSHER/PULLER 1/4"	343	DISPENSER	
DASHBOARD		DISPENSER/HAND TOWEL ROLL STAND FOR DRAWERS	101
KIT OF 4 WINDSCREEN PROTECTORS	361	DISTRIBUTION	
DECK		ADBLUE DISTRIBUTION DEVICE	193
220V PLATE	14	ADJUSTMENT KIT VAG 2.5 PD TDI	211
24V PLATE	14	MASTER TIMING TOOL SET RENAULT/NISSAN/OPEL/VOLVO	205
DEGREASING		TIMING TOOLS FIAT 2.3 JTD	207
DEGREASING/CLEANING PRODUCT FOR WASHERS 25L	181	TIMING TOOLS RENAULT/OPEL/NISSAN/SUZUKI DCI	205
DELAY TIME		DISTRIBUTION BARREL	
SET OF TOOLS GASKET INSTALLATION DELAY TIME SCANIA (TYPE 2)	239	MOBILE OIL DISTRIBUTION BARREL 180-220kg	173
DENT PULLER		DISTRIBUTOR PNEUMATIC OIL	
14 PCS BODYWORK ROD SET	344	PNEUMATIC OIL DISTRIBUTOR 24L	172-199
50 PULLING RINGS SET	327	DIVERSION	
50 PULLING STARS SET (5 POINTED)	327	ALUMINUM DIVERSION Ø16mm	64
50 PULLING TRIANGLES SET	327	ALUMINUM DIVERSION Ø20mm	64
BODYWORK LAMP	346	ALUMINUM DIVERSION Ø25mm	64
CENTRAL UNIT SPOT WELD AND DENT PULLER	327	DOOR HANDLE	
CHARGER FOR SPOTER PULLING RINGS	327	SEMI-RIGID ROD TO HOOK DOOR HANDLES OR KEYS 1.25m	348
LEVER PULLING BY POINT + 2 M5 ROUND ELECTRODES (SA0447)	327	SEMI-RIGID ROD TO HOOK DOOR HANDLES OR KEYS 1.80m	348
M5 ROUNDED ELECTRODE	327	SLIP KNOT SEMI-RIGID ROD TO HOOK DOOR HANDLES 1.10m	348
PULLING TWISTED 90° RINGS SET	327	DOOR OPENING	
RINGS/TRIANGLES/STARS HOLDER ELECTRODE	327	9 DOOR OPENING SET	348
SLIDE STRAIGHTENING HAMMER FOR SPOT REPAIRS	327	DOUBLE HEX	
SPOT WELD AND DENT PULLER	327	3/4" DOUBLE HEX SOCKET 22mm	121
DENT PULLER BIT		DPF	
4 END SET	344	DPF ASSEMBLY/DISASSEMBLY SCANIA	209
DENT REMOVAL		DRAIN	
BLOCK ANVIL 80x62x55mm	147	13 BLOCK DRAIN PLUGS KIT	197
BLOCK CLAW 78x60x27mm	147	3/8" DRAIN BIT SET	197
BLOCK COMMA 130x55mm	147	CONNECTION DRAIN AND COOLING CIRCUIT FILLING SCANIA	202
BLOCK RAIL/UNIVERSAL 60X60X56mm	147	HGV AXLE DRAIN PAN	169
FINISHING HAMMER ROUND/CROSS-HATCHED SQUARE	147	DRAIN BIT	
HAMMER + BLOCK SET	147-341	3/8" DRAIN BIT SET	197
PLANISHING HAMMER WITH HORIZONTAL TIP	147		

DRAIN CAP			
13 BLOCK DRAIN PLUGS KIT		197	
DRAIN TRAY			
HGV AXLE DRAIN PAN		169	
DRAWER			
3 DRAWER ROLLER CABINET/1 CASE 185 TOOLS		103	
3 DRAWER ROLLER CABINET/1 CASE 203 TOOLS		103	
4 DRAWERS + 1 DOOR ROLLER CABINET HGV		96	
7 DRAWER ROLLER CABINET 185 TOOLS		104	
7 PCS T-HANDLE WRENCH INSERT TORX T10-T40		139	
7 PCS T-HANDLE WRENCH SET TORX T10-T40		139	
DRAWER		39	
METAL WORKSHOP WASTE FOR DRAWER		101	
DRILL			
170PCS DRILL SET HSS COBALT 5%		376-43	
170PCS DRILL SET HSS4241		43	
25PCS DRILL SET HSS COBALT 5%		376-44	
25PCS DRILL SET HSS4241		44	
SCREW EXTRACTOR SET + HSS DRILLS Ø2-Ø7.5mm		44	
DRILLING			
REAR PARKING SENSOR PUNCH TOOL Ø24mm		371	
REAR PARKING SENSOR PUNCH TOOL Ø27mm		371	
REAR PARKING SENSOR PUNCH TOOL Ø30mm		371	
REAR PARKING SENSOR PUNCH TOOL Ø32mm BMW/VAG/OPEL		371	
DRUM			
ADAPTER FOR DRUMS M/F Ø55mm		171	
ADAPTER FOR DRUMS M/F Ø70mm		171	
CALIPER BASE Ø DISKS AND BRAKE DRUMS		252	
DRUM GRIP 350kg		153-175	
DRUM SUPPORT 220l		174	
FUNNEL FOR DRUMS 200L		175	
MOBILE OIL DISTRIBUTION BARREL 180-220kg		173	
PNEUMATIC OIL PUMP+SUCTION TUBE FOR 180-220kg DRUMS		173	
SPILL CONTAINMENT TRAY 250l 2 DRUMS		175	
SPILL CONTAINMENT TRAY 480l 4 DRUMS		175	
TRANSFER PUMP FOR DRUMS 200L		170	
DRUM CARRIER			
DRUM GRIP 350kg		153-175	
DRUM HOLDER			
LIFT TROLLEY WITH SCISSORS 800kg (HGV DRUM HOLDERS)		261	
DRWAER			
7 DRAWER ROLLER CABINET 203 TOOLS		104	
DRYER			
SCREW SUPERCHARGER 15CV EQUIPPED WITH DRYER+500l TANK 10bar		60	
DRYING			
2 DRYING GUNS + BASES		340-92	
4 DRYING GUNS + 2 BASES		340-92	
DRYING GUN		340-92	
DRYING GUN			
2 DRYING GUNS + BASES		340-92	
DRYING GUN		340-92	
DUMMY INJECTOR			
UNIVERSAL DUMMY INJECTOR		227	
DUMMY SPARK PLUG			
DIESEL GLOW PLUG KIT		227	
DUST			
DRY AND WET VACUUM CLEANER 2x1000W+FRONT BRUSH ASSEMBLY 600mm		177-350	
DUST VACUUM			
600mm FRONT BRUSH ASSEMBLY WITH HOSE		177-350	
DRY AND WET VACUUM CLEANER 2x1000W		177-350	
ELBOW			
COMPOSITE ELBOW 45° FOR Ø20mm		64	
COMPOSITE ELBOW 90° FOR Ø16mm		64	
ELECTRIC VEHICULE REEL			
TYPE 1 WALLBOX WIFI REEL FOR ELECTRIC VEHICLE POWER SUPPLY		67	
TYPE 2 WALLBOX WIFI REEL FOR ELECTRIC VEHICLE POWER SUPPLY		67	
ELECTRICAL HEATER			
ELECTRICAL HEATER SUNBEAM		38	
ELECTRODE			
BAG OF 10 ELECTRODES		326	
REMOVAL ELECTRODE SOCKET INJECTORS HPI SCANIA PUMP (BOSCH)		221	
ELECTRODE SOCKET			
ELECTRODE REMOVAL WRENCH 1/2"		217	
ELECTRONIC CABLE REEL			
WORKSHOP CABLE REEL 3x1.5mm ² 20m		68	
ELECTRONIC GAS HEATER			
ELECTRONIC GAS HEATER K2 CG-E		36	
ELEVATING TABLE			
500kg HYDRAULIC LIFT TABLE		153-40	
LIFT TROLLEY WITH SCISSORS 800kg (HGV DRUM HOLDERS)		261	
ENGINE FLYWHEEL			
ENGINE CRANK ROTATOR TOOL SCANIA		209	
FLYWHEEL ROTATION TOOL MAN		211	
FLYWHEEL ROTATOR TOOL FOR ACTROS/ATEGO/MAN ENGINES		211	
FLYWHEEL ROTATOR TOOL FOR IVECO ENGINES		206	
FLYWHEEL ROTATOR TOOL FOR MERCEDES/MAN ENGINES		211	
FLYWHEEL ROTATOR TOOL FOR RENAULT MAGNUM ENGINES		204	
FLYWHEEL ROTATOR TOOL FOR RENAULT/VOLVO ENGINES		204	
FLYWHEEL ROTATOR TOOL FOR VOLVO ENGINES		204	
LIEBHERR ENGINE ROTATION TOOL		212	
ERP END			
10 ERP ENDS 7.2mm PASSAGE FEMALE 1/4"		74	
10 ERP ENDS 7.2mm PASSAGE FOR HOSES Ø10mm		74	
10 ERP ENDS 7.2mm PASSAGE FOR HOSES Ø8mm		74	
10 ERP ENDS 7.2mm PASSAGE MALE 1/4"		74	
EXHAUST			
COMPRESSED AIR POWERED EXHAUST GAS EXTRACTOR		183	
DUAL EXHAUST SYSTEM GAS EXTRACTOR		183	
EXHAUST END Ø100mm		185	
EXHAUST END Ø150mm		186	
EXHAUST GAS EXTRACTOR		183	
L.3m FLEXIBLE BACKFLOW HOSE Ø125mm		184	
MECHANICAL EXTRACTOR REEL GAS HGV		186	
METER CRUSH-PROOF 200°C EXHAUST PIPE Ø100mm		185	
METER CRUSH-PROOF 200°C EXHAUST PIPE Ø150mm		186	
METER HIGH TEMPERATURE 500°C EXHAUST PIPE Ø100mm		185	
OVAL EXHAUST END (DUAL PIPE) Ø100		185	
RUBBER NOZZLE WITH CLIP Ø125mm		185	
EXHAUST GAS			
COMPRESSED AIR POWERED EXHAUST GAS EXTRACTOR		183	
DUAL EXHAUST SYSTEM GAS EXTRACTOR		183	
EXHAUST GAS EXTRACTOR		183	
EXTRACTOR UNIT GAS PORTABLE HGV		186	
FILTER		183	
GAS EXTRACTOR REEL Ø100mm 0.75kW		184	
L.3m FLEXIBLE BACKFLOW HOSE Ø125mm		184	
MECHANICAL EXTRACTOR REEL GAS HGV		186	
PORTABLE EXHAUST GAS EXTRACTOR		184	
Ø80mm EXTRACTION HOSE L.6m		183	

INDEX • THEMATIC

EXHAUST GAS EXTRACTION		EXTRACTOR WINDSCREEN WIPER	
DUAL EXHAUST SYSTEM GAS EXTRACTOR	183	UNIVERSAL WINDSCREEN WIPER EXTRACTOR	358
EXHAUST GAS EXTRACTOR		FACIAL SCREEN	
COMPRESSED AIR POWERED EXHAUST GAS EXTRACTOR	183	FACIAL PROTECTION SCREEN FOR ELECTRICAL ARCS	27
GAS EXTRACTOR REEL Ø100mm 0.75kW	184	FAST TAPPED CONNECTOR	
PORTABLE EXHAUST GAS EXTRACTOR	184	4 UNIVERSAL FAST TAPPED CONNECTOR SET FEMALE 1/4"	76
EXHAUST GAS PIPE		FILLING	
L.3m FLEXIBLE BACKFLOW HOSE Ø125mm	184	COOLING LINE FILLING DEVICE	202
EXHAUST GAS REEL		FILM REMOVAL TINTED PANES	
GAS EXTRACTOR REEL Ø100mm 0.75kW	184	FILM REMOVAL KIT FOR TINTED PANES	354
EXTENSION		FILTER	
1" EXTENSION	126	3/8" D. FILTER WRENCH Ø46mm MERCEDES BLUE-TEC	190
1/2" EXTENSION	114	30 MULTI-BRAND CAP OIL FILTER SET	196
1/2" IMPACT WRENCH SET 13 PCS	79	ADJUSTABLE PLIER FOR OIL FILTERS HGV	195
1/4" EXTENSION	108	DIESEL FUEL FILTER REMOVAL KIT OPEL/FIAT/PSA/SUZUKI/SAAB/LANCIA	190
3/4" EXTENSION	123	DOUBLE-CHAIN FILTER WRENCH Ø60-160mm	195
3/8" EXTENSION	110	FILTER	183
EXTENSION	158	FILTER WRENCH 122-155mm	195
RATCHET HANDLE + 11 HEX SOCKETS 1" D. FOR HGV 36-80	126	FILTER WRENCH 45-111mm + 3/8" + 1/2" D.-3/8" REDUCER	195
RATCHET+10 DOUBLE HEX SOCKET SET 3/4" D. 22-50mm	123	FILTER WRENCH OIL/PETROL 3/8" MANN/MAHLE/KNECHT	195
RATCHET+10 HEX SOCKET SET 3/4" D.	123	FILTER WRENCH Ø107mm 18-SIDED	195
RATCHET+8 HEX SOCKET SET 1" D.	126	FUEL FILTER WRENCH 3/8" FORD TRANSIT/MONDEO 2.2I TDCI	190
EXTRACTION		FUEL FILTER WRENCH PSA/RENAULT 3/8"	190
18T HYDRAULIC EXTRACTOR	278	FUEL FILTER WRENCH Ø109mm PSA/RENAULT 3/8"	191
BRAKE DISC EXTRACTION JACKS	263	GAZOLE FILTER WRENCH Ø95mm 14-SIDED	190
EXHAUST GAS EXTRACTOR	183	HGV STRAP WRENCH 1/2"	191
FORK Ø16mm FOR EXTRACTOR	218	OIL FILTER WRENCH Ø137mm 18-SIDED	190
GLOW PLUG REPAIR KIT M8x100 M10x100 M10X125 M12x125	245	FILTER PLIERS	
HYDRAULIC PUMP WITH FRAME AND SPINDLES	277	ADJUSTABLE PLIER FOR OIL FILTERS HGV	195
INERTIAL INJECTOR EXTRACTOR BOSCH/DELPHI	218	FILTER WRENCH	
PNEUMATIC VACUUM BRAKE BLEEDER	258	30 MULTI-BRAND CAP OIL FILTER SET	196
UPPER/LOWER HUB RENAULT/OPEL EXTRACTION RING SET	277	FILTER WRENCH 122-155mm	195
EXTRACTION INJECTORS		FILTER WRENCH 45-111mm + 3/8" + 1/2" D.-3/8" REDUCER	195
VIBRATION PNEUMATIC PULLER FOR EXTRACTION INJECTORS	220	FILTER WRENCH OIL/PETROL 3/8" MANN/MAHLE/KNECHT	195
EXTRACTION RINGS		FILTER WRENCH Ø107mm 18-SIDED	195
UPPER/LOWER HUB RENAULT/OPEL EXTRACTION RING SET	277	FUEL FILTER WRENCH 3/8" FORD TRANSIT/MONDEO 2.2I TDCI	190
EXTRACTOR		FUEL FILTER WRENCH Ø109mm PSA/RENAULT 3/8"	191
3 BALL JOINT PULLER SET Ø23 TO Ø34mm	266	GAZOLE FILTER WRENCH Ø95mm 14-SIDED	190
BALL JOINT PULLER	266	HEX HUB SOCKET IVECO Ø90mm 1" D.	294
BALL JOINT SEPARATOR Ø18mm	266	IVECO OIL FILTER WRENCH SET	196
CYLINDER LINER APPLICATION TOOL 60-160mm	228	METAL STRAP WRENCH FOR DESICCANT CARTRIDGE	191
DRY AND WET VACUUM CLEANER 2x1000W+FRONT BRUSH ASSEMBLY 600mm	177-350	OIL FILTER WRENCH Ø107mm 15-SIDED	195
HYDRAULIC BALL JOINT PULLER KIT Ø30-34-40mm	266	OIL FILTER WRENCH Ø137mm 18-SIDED	190
HYDRAULIC PULLER FRONT AXLE SPACER MERCEDES/MAN	269	FITTING KIT	
INJECTOR LINER APPLICATION TOOL HPI SCANIA	222	ALUMINUM AIR PIPE AND FITTING KIT Ø16mm L.20M 3 DOWNPIPES	63
INJECTOR LINER APPLICATION TOOL PDE SCANIA	222	ALUMINUM AIR PIPE AND FITTING KIT Ø20mm L.30M 4 DOWNPIPES	63
INJECTOR LINER APPLICATION TOOL VOLVO/RENAULT 7-9L	222	ALUMINUM AIR PIPE AND FITTING KIT Ø25mm L.36M 5 DOWNPIPES	63
INJECTOR LINER APPLICATION TOOL VOLVO/RENAULT FH-FM	222	ALUMINUM AIR PIPE AND FITTING KIT Ø32mm L.60M 8 DOWNPIPES	62
INJECTOR LINER APPLICATION TOOL XPI SCANIA	222	FIXING GEL	
KNIVES + CLAWS SEPARATOR SET	282	UNIVERSAL GEL FOR ATTACHING RAIN SENSOR/LIGHT SENSOR (single dose)	360
MULTI-BRAND HUB PULLER (CARS & LCV)	284	FLARING	
STEERING GEARBOX PULLER	269	HYDRAULIC BRAKE PIPE FLARING TOOL SET DIN/SAE Ø4.75-5-6-8mm	259
UNIVERSAL HGV HUB PULLER (5 ARMS)	284	FLAT SOCKET	
WINDSCREEN WIPER REMOVER	358	SHORT BIT 10mm P08	142
EXTRACTOR FOR CONNECTION PLUGS		SHORT BIT 10mm P10	142
PULLER FOR EXTRACTING CONNECTION PLUGS SET	20-347	FLAT-HEAD	
EXTRACTOR UNIT		5 SCREWDRIVER SLOTTED 3 BITS SET 1/4"	142
DOUBLE EXTRACTOR GROUP	185	5 SCREWDRIVER SLOTTED 5 BITS SET 1/4"	142
PORTABLE EXHAUST GAS EXTRACTOR	184	5 SCREWDRIVER SLOTTED 6 BITS SET 1/4"	142
SINGLE EXTRACTOR GROUP	185		

FLAT-HEADED		
5 SCREWDRIVER SLOTTED 4 BITS SET 1/4"		142
FLATNESS		
CAST IRON SURFACE PLATE FOR CHECKING HEAD FLATNESS		230-53
FLEXIBLE		
1/4" FLEXIBLE EXTENSION		108
Ø80mm EXTRACTION HOSE L.6m		183
FLEXIBLE LINK		
FLEXIBLE LINK Ø25mm		64
FLEXIBLE LINK Ø32mm		64
FLEXIBLE LINK Ø40mm		64
FLUORESCENT LIGHT		
FLUORESCENT STRIP LIGHT 11W 2G7		15
FLUORESCENT TUBE		
2 PIN FLUORESCENT STRIP LIGHT 11W 220V		14
FOAM INSERT		
PRE-CUT FOAM INSERT 1 TABLE DRAWER FORMAT		112
FOOT STEP		
PAIR OF STEPS		363
FORCE BAR		
1/2" DRIVE L. 600MM FORCE HINGED HANDLE		114
3/4" DRIVE L. 950MM FORCE HINGED HANDLE		123
FORCE EXTENSION		
1/2" DRIVE L. 600MM FORCE HINGED HANDLE		114
3/4" DRIVE L. 950MM FORCE HINGED HANDLE		123
FORGED STEEL		
FORGED STEEL HAMMER 1250g		146
FORK		
FORK HOLDING TOOL FOR ZF AS TRONIC GEARBOX		237
FORK HOLDING		
FORK HOLDING TOOL FOR ZF AS TRONIC GEARBOX		237
FREEWHEELING ALTERNATOR PULLEY DISMANTLING		
30PCS FREEWHEELING ALTERNATOR PULLEY DISMANTLING KIT		213
FUEL		
3 PLIER SET FOR FUEL LINE CONNECTORS		189
DIESEL FUEL FILTER REMOVAL KIT OPEL/FIAT/PSA/SUZUKI/SAAB/LANCIA		190
FILTER WRENCH OIL/PETROL 3/8" MANN/MAHLE/KNECHT		195
FUEL FILTER WRENCH 3/8" FORD TRANSIT/MONDEO 2.2I TDCI		190
FUEL FILTER WRENCH PSA/RENAULT 3/8"		190
FUEL TRANSFER PUMP		171
PETROL AND DIESEL FUEL CONNECTION PLIER		189
FUEL CONNECTOR		
FAST FUEL CONNECTORS CLAMP		189
FUEL PRESSURE		
FEMALE CONNECTOR SCANIA VOLVO ZF		226
MALE CONNECTOR SCANIA VOLVO ZF		226
FUEL PUMP		
FUEL TRANSFER PUMP		171
FUME EXTRACTOR DIESEL		
DIESEL FUME EXTRACTOR		214
FUNNEL		
3 PCS FUNNEL SET Ø165mm		172
FLEXIBLE SPOUT FUNNEL Ø145mm		172
FUNNEL FOR DRUMS 200L		175
FUSE		
120 PCS 5-30A FUSE SET		19
FUSE TESTER 6-12-24V		19
FUSE TESTER		
FUSE TESTER 6-12-24V		19
GAS		
GAS REFILL		21-328
GAS EXTRACTION		
FILTER		183
GAS HEATER		
GAS HEATER K2 CG 850		35
GAS HEATER KAIFER 100		37
MANUAL GAS HEATER K2 CG-M		36
GASKET		
SET OF TOOLS GASKET INSTALLATION DELAY TIME SCANIA (TYPE 2)		239
GAUGE		
FEELER GAUGE SET		231-53
GEARBOX AND DISTRIBUTION SHAFT MOUNTING GAUGE IVECO 10L		206
GEARBOX AND DISTRIBUTION SHAFT MOUNTING GAUGE IVECO 13L		206
GEARBOX		
11 BALL BEARING EXTRACTOR FOR ZF AS TRONIC GEARBOX		237
2 SPACER PLIERS GEARBOX COVER		238
3 BEARING MOUNTING TUBES FOR ZF16 ECOSPLIT GEARBOX		236
3 SYNC CENTERING GUIDES FOR ZF AS TRONIC GEARBOX		237
4-LUG SOCKET 1" FOR INTERNAL NUT SCANIA BOX		239
4-LUG SOCKET 1/2" FOR DELAYING SCANIA (TYPE 1)		239
4-LUG SOCKET 1/2" FOR DELAYING SCANIA (TYPE 2)		239
4-LUG SOCKET 3/4" FOR SCANIA GEARBOXES WITHOUT DELAYER		239
4-LUG THIN SOCKET 3/4" FOR SCANIA GEARBOXES WITH DELAYER		239
BEARING PULLER FOR GEARBOXES ZF SET		237
BEVEL BEARING GEAR PULLER FOR ZF AS TRONIC GEARBOXES		237
FORK HOLDING TOOL FOR ZF AS TRONIC GEARBOX		237
GEARBOX REFILLING DEVICE WITH ADAPTERS		234
INSTALLATION/REMOVAL PRIMARY SHAFT ZF AS TRONIC GEARBOX		237
MOVE/REMOVE HYDRAULIC KIT FOR VT VOLVO/RENAULT GEARBOX SYNCHRO		238
NEUTRAL POSITION ADJUSTMENT TOOL FOR ZF AS TRONIC GEARBOX		235
OIL DISTRIBUTOR REMOVAL WRENCH VT VOLVO/RENAULT GEARBOX		238
OUTPUT FLANGE LOCKING TOOL FOR VOLVO/RENAULT GEARBOX		238
PRIMARY SHAFT POSITIONING TOOL ZF AS TRONIC GEARBOX		237
PRIMARY SHAFT SUPPORT FOR ZF ECOSPLIT GEARBOX		235
PRIMARY/SECONDARY SHAFT UNLOCKING TOOL FOR ZF16 ECOSPLIT GEARBOX		236
SET OF 6 SYNCHRO MOUNTING CLIPS. REDUCING GROUP FOR ZF AS TRONIC GEARBOX		237
SHAFT BEARING INSTALLATION GUIDE IVECO DAILY		282-294
SPLITTER ADJUSTMENT TOOL FOR ZF ECOSPLIT GEARBOX		235
GEARBOX BEARING		
BEARING AND GEARWHEEL PULLER FOR ZF16 221-251 GEARBOX		236
SHAFT BEARING INSTALLATION GUIDE IVECO DAILY		282-294
GEARBOX REFILLING		
GEARBOX REFILLING DEVICE WITH ADAPTERS		234
GLASS COVER		
GLASS COVER		14
GLASS ENGRAVING		
ENGRAVING GUN		357
GLASS ENGRAVING CASE		357-93
GLOVES		
LEATHER OVERGLOVES FOR INSULATED GLOVES		27
PAIR OF 1000V INSULATING GLOVES		27
PAIR OF ULTRANITRIL GLOVES FOR AIR CONDITIONING MAINTENANCE IN388 EN374		247
PERSONAL ELECTRICAL PROTECTION EQUIPMENT SET		27
GLOW		
GLOW PLUG REPAIR KIT M8x100 M10x100 M10x125 M12x125		245
VIBRATION GLOW PLUG REMOVAL KIT 1/4"		244

INDEX • THEMATIC

GLOW PLUG EXTRACTOR			
DIESEL UNIVERSAL GLOW PLUG EXTRACTOR	245	PLANISHING HAMMER WITH ROUND FLAT HEAD AND POINTED TIP	147
GLOW PLUGS			
INJECTOR/GLOW PLUG RELEASER 500ml	215	RIVOIR HAMMER ASH TREE HANDLE 1500gr	145
GLUE			
10 AMBER GLUE STICK SET	346	RIVOIR HAMMER COMPOSITE HANDLE 1000gr	145
AIR CAULKING GUN	366-90	RUBBER HAMMER 300mm 540g	146
BI-COMPOSING GUN 50ml	374-91	HANDLE	
BLACK STRUCTURAL GLUE 50ml	374-49	1" SLIDING T-HANDLE	126
GLUE AND WHITE MASTIC CARTRIDGE 310ml	334-49	1" SLIDING T-HANDLE L.550mm	126
MULTI-FUNCTIONAL GLUE SPRAY 400ml	356-48	1/4" L-HANDLE	107
STRUCTURAL GLUE MIXING NOZZLE	49	1/4" SLIDING T HANDLE	108
SUPPLE SUPER GLUE 20g	360-50	3/4" SLIDING T-HANDLE L.500mm	123
GLUE GUN		EXTRA LONG HANDLE FOR PNEUMATIC JACK	158
AIR CAULKING GUN	366-90	HANDLING	
GREASE		MULTIFUNCTIONAL FOLDING WORKSHOP TROLLEY 150kg	323-42
TIRE MOUNTING GREASE SPRAY 400ml	309	HANGING DIESEL HEATER	
TRANSLUCENT TIRE MOUNTING CREAM 5kg	309	DIRECT DIESEL OIL HANGING HEATER + EXCHANGER ANTARES 50	32
Ø30mm ELBOW BRUSH FOR MOUNTING CREAM	309	DIRECT DIESEL OIL HANGING HEATER + EXCHANGER ANTARES 70	32
Ø32mm STRAIGHT BRUSH FOR TIRE MOUNTING CREAM	309	DIRECT DIESEL OIL HANGING HEATER + EXCHANGER ANTARES 80	32
GREASE GUN		HEADLAMP	
GREASE GUN 500ml	173-91	HEADLAMP MAGNETIC SUPPORT RECHARGEABLE 480Lm	17
GREASE PUMP		HEADLIGHT	
PNEUMATIC GREASE GUN 450ml	91	VAG HEADLIGHT ADJUSTMENT TOOL	368
GRINDER		HEADLIGHT ADJUSTER	
ABRASIVE DISC HOLDER TRAY Ø50mm	329-86	DUAL LASER/CAMERA HEADLIGHT ADJUSTER	367
MINI ANGLE DIE GRINDER Ø6mm	329-86	HEADLIGHT ADJUSTMENT	
MINI DIE GRINDER Ø6mm 20,000rpm	86	VAG HEADLIGHT ADJUSTMENT TOOL	368
MINI DIE GRINDER Ø6mm 25,000rpm	329-86	HEADLIGHT ADJUSTMENT DEVICE	
PNEUMATIC GRINDER ACCESSORY SET 11PCS	85	DUAL LASER HEADLIGHT ADJUSTMENT DEVICE	368
PNEUMATIC MINI GRINDER SET 12PCS	85	STANDARD HEADLIGHT ADJUSTMENT DEVICE	369
GRINDING DISK		HEADLIGHT ALIGNER	
DRILLED SHAFT SUPPORT DISKS	86	DUAL LASER HEADLIGHT ADJUSTMENT DEVICE	368
GRINDING WHEEL		STANDARD HEADLIGHT ADJUSTMENT DEVICE	369
VITRIFIED GRINDING WHEEL GREY CORUNDUM 200x32x32mm GRIT 60	41	HEATING	
GRIP		FLEXIBLE INDUCTION COIL	57
INJECTOR EXTRACTION LEVER M12x1.00 MALE	218	INDUCTION HEATER	57
INJECTOR EXTRACTION LEVER M12x1.5 FEMALE	218	RIGID INDUCTION COIL	57
GUIDE		ROUND INDUCTION PAD Ø50mm	57
2 ADJUSTMENT JIGS FOR SCANIA PUMP INJECTORS	221	HEIGHT ADJUSTABLE JACK STAND	
MOUNTING GUIDE CYLINDER SET VOLVO/RENAULT 11-12-13-16L	204-231	PAIR OF HEIGHT ADJUSTABLE JACK STANDS 22T	156
PISTON INSERT GUIDE DAF	228	PAIR TALL JACK STANDS 2T	156
GUM		HGV	
ADAPTER FOR GUM AND BRUSH	85	2 PCS HGV CIRCLIP SET (INTERIOR-EXTERIOR)	135
GUM Ø86mm	86	4 PCS HGV PUNCH SET	149
HARD GUM Ø105mm	331-85	AIR HYDRAULIC JACK 10-22-40T	164
SOFT GUM Ø105mm	331-85	AIR HYDRAULIC JACK 15-30-50T	165
GUN		AIR HYDRAULIC JACK 15-30T	164
CARTRIDGE AND BAGS GUN 340mm 12:1	366-90	BRAKE PLIERS HGV L.520mm OPENING 210mm	253
CARTRIDGE SPRAY GUN (POLYMER MS)	333-91	HGV AIR REEL Ø13mm 20m	71
PNEUMATIC GREASE GUN 450ml	91	HGV AXLE DRAIN PAN	169
PNEUMATIC GUN FOR 370mm CARTRIDGES AND BAGS	366-90	HGV BEAD KEEPER FOR ALUMINUM WHEEL RIM	306
HAMMER		HGV BRAKE PLIERS L.670mm OPENING 200mm	253
ANTI-REBOUND HAMMER 4.5kg L.900mm	146-287	HGV CLUTCH ALIGNMENT TOOL	232
BALL PIN HAMMER 440gr	147-341	HYDROPNEUMATIC BEAD BREAKER + PUMP/HOSE/CONNECTOR	307
DEAD BLOW HAMMER WITH INTERCHANGEABLE TIP 32mm	145-349	LEVER L.530mm FOR SMALL TUBELESS TRUCK TIRES	307
FINISHING HAMMER ROUND/CROSS-HATCHED SQUARE	147	LONG CHASSIS SERVICE JACK 10T L.1637mm	163
FORGED STEEL HAMMER 1250g	146	PUMP SUCTION CUP HGV Ø254mm CAPACITY 140kg	364
HAMMER + BLOCK SET	147-341	TIRE LIFTING DOLLY HGV	299
PLANISHING HAMMER WITH HORIZONTAL TIP	147	TORQUE MULTIPLIER R1:58 4800Nm+6 SOCKETS + 2 ADAPTERS 1" HGV	126-287
		UNIVERSAL CRIMPING PLIER FOR HGV	203
		UNIVERSAL HGV HUB COVER REMOVAL TOOL	298
		WHEEL DOLLY HGV	299

WHEEL STUD THREAD RESTORER HGV	285	SPIRAL 4000mm Ø42mm	177-350
HGV EXTRACTOR		Ø80mm EXTRACTION HOSE L.6m	183
EXTRACTOR UNIT GAS PORTABLE HGV	186	HOSE CLAMP	
MECHANICAL EXTRACTOR REEL GAS HGV	186	3 HOSE CLAMP SET	203
HGV EXTRACTOR UNIT		HOSE CLAMP	203
EXTRACTOR UNIT GAS PORTABLE HGV	186	L-SHAPED HOSE CLAMP	203
HGV JACK STANDS		SET OF 3 L-SHAPED HOSE CLAMP	203
HGV JACK STAND 7.5-1800	318	HUB	
HGV MOBILE LIFT		1" D. HEX REAR HUB SOCKET IRISBUS/VOLVO Ø105mm	287
4 MOBILE HGV LIFT COLUMNS 5.5T RG5.5-4 WIRE CONNECTION	317	1/2" IMPACT SOCKET BIT SET HUB AND CV JOINT	116
6 MOBILE HGV LIFT COLUMNS 5.5T RG5.5-6 WIRE CONNECTION	318	12 & 6 PIN REVERSIBLE HUB SOCKET MAN/MERCEDES Ø102mm	291
6 MOBILE HGV LIFT COLUMNS 7.5T RG7.5-6 WIRE CONNECTION	318	12 PIN REAR HUB SOCKET MERCEDES Ø90mm	292
HGV TIRE CHANGER		3/4" D. DOUBLE HEX SOCKET Ø56mm FORD TRANSIT	121-288
HGV TIRE CHANGER 19"-26" M126	303	4-PINS REAR HUB SOCKET FORD TRANSIT	288
HGV TIRE CHANGER <26" 1 SPEED SYSTEM 7226	302	6 PIN FRONT HUB SOCKET MAN Ø76.5mm	289
HGV TIRE CHANGER <56" 1 SPEED SYSTEM M156	301	6 PIN FRONT HUB SOCKET MAN Ø77mm	289
HGV TIRE CHANGER <56" 2 SPEED SYSTEM 7256	300	6 PIN HUB SOCKET MAN & MERCEDES Ø117mm	291
HGV WHEEL BALANCER		6 PIN HUB SOCKET MERCEDES ATEGO Ø101mm	293
HGV WHEEL BALANCER W142	310	6 PIN HUB SOCKET MERCEDES ATEGO Ø101mm	292
MOBILE HGV WHEEL BALANCER W102	311	6 PIN REAR HUB NUT SOCKET MERCEDES Ø75mm	292
HIGH ELEVATION		6 PIN REAR HUB SOCKET MERCEDES Ø71.5mm	292-293
HIGH ELEVATION HYDRAULIC FLOOR JACK 3T	159	6 PIN REAR HUB SOCKETS MAN BUS Ø110mm	290
HIGH LIFT AIR HYDRAULIC JACK 30T	165	6 PIN SOCKET FOR REAR AXLE NUT MERCEDES CITARO Ø123.5mm	290
HINGED HANDLE		6 PIN TRAILER HUB SOCKET MERCEDES Ø113mm	292
1/2" DRIVE L. 600MM FORCE HINGED HANDLE	114	8-SIDED FRONT HUB NUT SOCKET SCANIA Ø80mm	295
3/4" DRIVE L. 950MM FORCE HINGED HANDLE	123	8-SIDED HUB SOCKET R.O.R TRAILERS 84mm	298
HOLDER		8-SIDED REAR HUB NUT SOCKET SCANIA Ø100mm 3/4"	295
BODYWORK HOLDER	363	ABS SEALANT INSTALLATION TOOL VOLVO/RENAULT	261
RIM STAND	324	DOUBLE HEX HUB SOCKET IVECO Ø85mm	294
UNIVERSAL TELESCOPIC BODYWORK HOLDER 23-138cm	324	FRONT WHEEL HUB REMOVER MAN Ø166mm	269
HOLLOW PUNCH		GROOVE NUT SOCKET WITH 8 STUDS SCANIA 420 Ø103mm	295
13 PCS HOLLOW PUNCH SET Ø5-Ø35mm	148	HEX HUB SOCKET IVECO Ø90mm 1" D.	294
REAR PARKING SENSOR PUNCH TOOL KIT Ø17-Ø22mm	371	HEX HUB SOCKET RENAULT FONTENAC TRAILER Ø160mm	288
HOLLOW STARTING NEEDLE		HEX HUB SOCKET RENAULT/SAF Ø140mm	298
HOLLOW STARTING NEEDLE	359	HEX MERCEDES HUB SOCKET Ø95mm	293
HOOK		HEX REVERSIBLE HUB SOCKET FRUEHAUF TRAILERS 123mm/110mm	298
20 MAGNETIC HOOKS SET	100	HUB SOCKET BPW TRAILER 12T	296
4 HOOK SET FOR JOINTS	212	HUB SOCKET BPW TRAILERS 6.5-9T	296
BAG OF 10 DOUBLE HOOKS Ø6mm L.100mm	101-39	HUB WRENCH DOUBLE HEX Ø65mm 3/4" IVECO DAILY/FORD TRANSIT	121
BAG OF 10 DOUBLE HOOKS Ø6mm L.50mm	101-39	MULTI-BRAND HUB PULLER (CARS & LCV)	284
BAG OF 10 SIMPLE HOOKS Ø6mm L.50mm	101-39	REAR HUB BOLT REMOVAL WRENCH RENAULT/MASCOTT 3/4" D.	288
BLACK HOOK+HOLDER	14-15	REAR HUBCAP NUT SOCKET BPW 12T 109mm 8-SIDED	296
HOSE		REAR HUBCAP NUT SOCKET BPW 12T 111mm	297
1/4 AIR SPIRAL HOSE L.75m	76	REAR HUBCAP NUT SOCKET BPW 16T 110mm 8-SIDED	297
10 ERP ENDS 7.2mm PASSAGE FOR HOSES	74	RECTANGULAR HUB SOCKET FOR KASSBOHRER/SETRA/DAF/MERCEDES 56x71mm	293
10 IRP ENDS 6mm PASSAGE FOR HOSES	71-75	RECTANGULAR HUB SOCKET MAN/MERCEDES 60x76mm	290
10 IRP ENDS 8mm PASSAGE FOR HOSES	75	UNIVERSAL HGV HUB COVER REMOVAL TOOL	298
3 HOSE CLAMP SET	203	UNIVERSAL HGV HUB PULLER (5 ARMS)	284
3/16" ADAPTER	259	WHEEL CAPSULE AND AXLE NUT SOCKET 65mm 3/4"	298
EXHAUST PNEUMATIC SLEEVE FOR 3/4" AND 1" IMPACT WRENCHES	80	HUB PULLER	
FAST CONNECTOR PASSAGE 6mm FOR HOSES Ø8mm	75	FRONT WHEEL HUB REMOVER MAN Ø166mm	269
FAST CONNECTOR PASSAGE 7.2mm FOR HOSES	74	HUB SOCKET	
FAST CONNECTOR PASSAGE 8mm FOR HOSES	75	1/2" IMPACT SOCKET BIT SET HUB AND CV JOINT	116
HYDRAULIC CONNECTION KIT IVECO	270	12 & 6 PIN REVERSIBLE HUB SOCKET MAN/MERCEDES Ø102mm	291
HYDRAULIC CONNECTION KIT MAN	270	12 PIN REAR HUB SOCKET MERCEDES Ø90mm	292
HYDRAULIC CONNECTION KIT VOLVO/SCANIA/RENAULT	270	3/4" D. DOUBLE HEX SOCKET Ø56mm FORD TRANSIT	121-288
LONG FLEXIBLE MAGNETIC SHAFT	54	6 PIN FRONT HUB SOCKET MAN Ø76.5mm	289
MAGNETIC PICK UP TOOL Ø5mm	54	6 PIN FRONT HUB SOCKET MAN Ø77mm	289
METER CRUSH-PROOF 200°C EXHAUST PIPE	185	6 PIN HUB SOCKET MAN & MERCEDES Ø117mm	291
METER HIGH TEMPERATURE 500°C EXHAUST PIPE Ø100mm	185	6 PIN HUB SOCKET MERCEDES ATEGO Ø101mm	293
SET OF 3 L-SHAPED HOSE CLAMP	203	6 PIN REAR HUB NUT SOCKET MERCEDES Ø75mm	292

INDEX • THEMATIC

6 PIN REAR HUB SOCKET MERCEDES Ø71.5mm	292-293	1/2" D. HEX IMPACT UNIVERSAL JOINT SOCKET	111
6 PIN SOCKET FOR REAR AXLE NUT MERCEDES CITARO Ø123.5mm	290	1/2" D. HEXAGONAL IMPACT SOCKET BIT	117
6 PIN TRAILER HUB SOCKET MERCEDES Ø113mm	292	1/2" D. RIBE IMPACT SOCKET BIT	117
8-SIDED HUB SOCKET R.O.R TRAILERS 127mm	298	1/2" D. TORX IMPACT SOCKET BIT	117
8-SIDED HUB SOCKET R.O.R TRAILERS 84mm	298	1/2" D. XZN IMPACT SOCKET BIT	117
DOUBLE HEX HUB SOCKET IVECO Ø85mm	294	1/2" HEX IMPACT SOCKET	111
GROOVE NUT SOCKET WITH 8 STUDS SCANIA 420 Ø103mm	295	1/2" IMPACT SOCKET TORX	111
HEX HUB SOCKET RENAULT FONTENAC TRAILER Ø160mm	288	1/2" IMPACT WRENCH SET 13 PCS	79
HEX HUB SOCKET RENAULT/SAF Ø140mm	298	1/2" LONG HEX IMPACT SOCKET	111
HEX MERCEDES HUB SOCKET Ø95mm	293	10 IMPACT SOCKET KIT 10-27mm 1/2"	113
HEX REVERSIBLE HUB SOCKET FRUEHAUF TRAILERS 123mm/110mm	298	13 LONG HEX IMPACT SOCKET KIT 10-30mm 1/2"	113
HUB SOCKET BPW TRAILER 12T	296	135Nm IMPACT TORQUE EXTENSION	115
HUB SOCKET BPW TRAILERS 6.5-9T	296	3 IMPACT SOCKET KIT FOR ALU RIMS	115
REAR HUBCAP NUT SOCKET BPW 12T 109mm 8-SIDED	296	3/4" WHEEL NUT SQUARE SOCKET L.90mm	287
REAR HUBCAP NUT SOCKET BPW 12T 111mm	297	3/4" HEX IMPACT SOCKET	121
REAR HUBCAP NUT SOCKET BPW 16T 110mm 8-SIDED	297	3/4" LONG HEX IMPACT SOCKET	121
HYBRID		3/4" LONG HEX IMPACT SOCKET SET 26-38mm	122
4 INSULATION CAPS Ø10mm L.60mm	27	3/8" HEX IMPACT SOCKET	110
4 INSULATION CAPS Ø15mm L.100mm	27	5 ALU WHEEL RIM 1/2" IMPACT SOCKET SET	115-286
4 INSULATION CAPS Ø20mm L.120mm	27	8 IMPACT SOCKET KIT 10-19mm 3/8"	110
CLASS 3 INSULATING MAT - 100x60cm	27	9 HEX IMPACT SOCKET KIT 24-50mm 1"	125
HYBRID AND ELECTRIC VEHICLES INSULATED TOOLS 1000V	26	EPL IMPACT SOCKET 32mm 3/4" MERCEDES	267
HYBRID AND ELECTRIC VEHICLES SECURITY KIT+PPE	25	HEX 8 IMPACT SOCKET KIT 26-38mm 3/4"	122
INSULATING RESCUE ROD L.147cm	29	IMPACT SOCKET E28 3/4" L 90mm CYLINDER HEAD FOR MAN/SCANIA	231
INSULATING SHEET 3/10th 12.5x1.3m	29	IMPACT SOCKETS SET 1/2" D. L.76mm E10-E11-E12-E14-E16-E18-E20-E22-E24	113
PPE PACK + 1000V VARIOUS TOOLS	25		
HYDRAULIC EXTRACTION		IMPACT WRENCH	
HYDRAULIC GEAR PULLER SET 10T	282	1" D. ALUMINUM IMPACT WRENCH 2034Nm	80
HYDRAULIC EXTRACTOR		1" D. HGV IMPACT WRENCH 3390Nm	80
MOVE/REMOVE HYDRAULIC KIT FOR VT VOLVO/RENAULT GEAR-BOX SYNCHRO	238	1" D. IMPACT WRENCH 2441Nm	315-80
HYDROPNEUMATIC		1/2" D. COMPACT IMPACT WRENCH 1084Nm DOUBLE HAMMER	315-78
AIR HYDRAULIC JACK 10-22-40T	164	1/2" D. IMPACT WRENCH 1492Nm DOUBLE HAMMER	78
AIR HYDRAULIC JACK 15-30-50T	165	1/2" D. IMPACT WRENCH 1756Nm	78
AIR HYDRAULIC JACK 15-30T	164	1/2" RECHARGEABLE IMPACT WRENCH 600Nm	315-79
DUAL-CONTROL HYDRAULIC PRESS 30T SLIDING CYLINDER	151	1/2" RECHARGEABLE IMPACT WRENCH 600Nm+ADDITIONAL BATTERY	79
DUAL-CONTROL HYDRAULIC PRESS 50T SLIDING CYLINDER	151	3/4" D. IMPACT WRENCH 1898Nm	315-80
HIGH LIFT AIR HYDRAULIC JACK 30T	165	3/8" D. BUTTERFLY IMPACT WRENCH KIT	77
HYDROPNEUMATIC BEAD BREAKER + PUMP/HOSE/CONNECTOR	307	4.0Ah LI-ION BATTERY	79
IGNITION TESTER		EXHAUST PNEUMATIC SLEEVE FOR 3/4" AND 1" IMPACT WRENCHES	80
12V BATTERY TESTER & 12/24V ALTERNATOR	240	VIBRATION GLOW PLUG REMOVAL KIT 1/4"	244
IMPACT		INCREASER	
PNEUMATIC CHISEL TOOLS	219-269-83	3/8"x1/2" INCREASER	109-110
VIBRO CHISEL SET	83		
IMPACT BIT		INDUCTION	
1/2" D. TORX IMPACT SOCKET BIT T20	117	FLEXIBLE INDUCTION COIL	57
1/2" D. TORX IMPACT SOCKET BIT T25	117	INDUCTION HEATER	57
1/2" D. TORX IMPACT SOCKET BIT T30	117	RIGID INDUCTION COIL	57
IMPACT TORX SOCKETS SET 1/2" D. T20-T25-T30-T40-T45-T50-T55-T60-T70	119	ROUND INDUCTION PAD Ø50mm	57
IMPACT EXTENSION		INDUCTION HEATER	
1/2" D. 110Nm IMPACT TORQUE EXTENSION	115	HGV INDUCTION HEATER	56
1/2" D. 120Nm IMPACT TORQUE EXTENSION	115	INERTIA	
135Nm IMPACT TORQUE EXTENSION	115	INERTIAL INJECTOR EXTRACTOR BOSCH/DELPHI	218
IMPACT SOCKET		INERTIAL	
1" D. IMPACT HEX SOCKET	124-288	SLIDE HAMMER FOR INJECTOR SEALS Ø3.5-15.5mm L.440mm	223
1" D. TORQUE CONTROL IMPACT SOCKET	124-286	INERTIAL EXTRACTOR	
1" D. TORQUE IMPACT SOCKET EXTRA DEEP 33mm 650Nm	124-286	UNIVERSAL EXTRACTION KIT BOSCH/DELPHI/DENSO/SIEMENS	218
1" HEX IMPACT SOCKET	124	INFARED HEATER	
1" LONG HEX IMPACT SOCKET	124	INFARED HEATER V40	30
1" LONG HEX IMPACT SOCKET SET 24-50mm 9 PCS	125	INFLATING GUN	
1/2" IMPACT TORQUE EXTENSION	115	INFLATING GUN 0-12bar	306-69

INFLATOR GUN		INJECTOR RETURN	
INFLATOR GUN 0.7-12bar	306-69	8-CYLINDER COMMON RAIL INJECTOR TESTER	215
INJECTOR		INJECTOR SEAL	
1/2" D. HEX SOCKETS SET FOR REMOVING DIESEL INJECTORS HEADS	216	INERTIAL INJECTOR GASKET EXTRACTOR	223
1/2" D. SOCKET SET FOR INSTALLING/REMOVING INJECTOR HOLDERS	216	INJECTOR SEAT	
2 ADJUSTMENT JIGS FOR SCANIA PUMP INJECTORS	221	COMPLETE INJECTOR SEAT CLEANING KIT	223
8-CYLINDER COMMON RAIL INJECTOR TESTER	215	INJECTOR SEAT CLEANING KIT	223
ADAPTER M18x1.5-M22x1.5	218	INJECTOR SOCKET	
ADAPTERS FOR BOSCH AND DELPHI INJECTORS	217	1/2" D. HEX SOCKETS SET FOR REMOVING DIESEL INJECTORS HEADS	216
COMPLETE INJECTOR SEAT CLEANING KIT	223	INJECTOR SOCKET MAN Ø28mm DOUBLE HEX	221
DIESEL INJECTOR CLEANER 300ml	224	INSERT	
EXTERNAL GRIP ADAPTER BOSCH INJECTORS	218	10 PCS M12x1.75 INSERT SET	46
INERTIAL INJECTOR EXTRACTOR BOSCH/DELPHI	218	10 PCS M14x1.25 INSERT SET	46
INERTIAL INJECTOR GASKET EXTRACTOR	223	10 PCS M14x2.0 INSERT SET	46
INERTIAL INJECTORS ADAPTER BOSCH	218	17 PCS COMBINATION WRENCH INSERT 6-24mm	129
INJECTOR	358	23 PCS 1/2" RATCHET INSERT	114
INJECTOR EXTRACTION KIT MERCEDES CDI	221	25 PCS M10x1.50 INSERT SET	46
INJECTOR EXTRACTOR KIT MERCEDES/CHRYSLER 2.1-2.2-3.0V6 CDI	221	25 PCS M5x0.8 INSERT SET	46
INJECTOR EXTRACTOR MAN	222	25 PCS M6x1 INSERT SET	46
INJECTOR EXTRACTOR PSA 2.0-2.2 HDI	220	25 PCS M8x1.25 INSERT SET	46
INJECTOR EXTRACTOR RENAULT/NISSAN/OPEL 2.0-2.2-2.5 DCI	219	3/8" RATCHET INSERT 21 PCS	110
INJECTOR LINER APPLICATION TOOL HPI SCANIA	222	4 PCS COMBINATION WRENCH INSERT 27-32mm	129
INJECTOR LINER APPLICATION TOOL PDE SCANIA	222	4 PCS PLIER INSERT	132
INJECTOR LINER APPLICATION TOOL VOLVO/RENAULT 7-9L	222	43 PCS SPECIAL BIT INSERT	143
INJECTOR LINER APPLICATION TOOL VOLVO/RENAULT FH-FM	222	59 PCS RATCHET INSERT 1/4"	108
INJECTOR LINER APPLICATION TOOL XPI SCANIA	222	7 PCS HEX T-HANDLE WRENCH INSERT 3-10mm	138
INJECTOR MECHANICAL-HYDRAULIC EXTRACTOR 12T	219	7 PCS TORX SCREWDRIVER INSERT T10-40	137
INJECTOR SEAT CLEANING KIT	223	8 PCS SCREWDRIVER INSERT	136
INJECTOR SOCKET MAN Ø28mm DOUBLE HEX	221	M10x1.50 INSERT SET	46
INJECTOR/GLOW PLUG RELEASER 500ml	215	M12x1.75 INSERT SET	46
PETROL INJECTOR CLEANER 300ml	224	M14x2.0 INSERT SET	46
REMOVAL ELECTRODE SOCKET INJECTORS HPI SCANIA PUMP (BOSCH)	221	M5-M12 INSERT SET	46
INJECTOR EXTRACTION		M5x0.8 INSERT SET	46
ADAPTER M18x1.5-M22x1.5	218	M6x1.0 INSERTS SET	46
INJECTOR EXTRACTION KIT MERCEDES CDI	221	M8x1.25 INSERT SET	46
INJECTOR EXTRACTION LEVER M12x1.00 MALE	218	INSPECTION CREEPER	
INJECTOR EXTRACTION LEVER M12x1.5 FEMALE	218	INSPECTION CREEPER 150Kg	42
INJECTOR EXTRACTOR KIT MERCEDES/CHRYSLER 2.1-2.2-3.0V6 CDI	221	INSPECTION DEVICE	
INJECTOR EXTRACTOR PSA 2.0-2.2 HDI	220	50-160mm DRILLING INSPECTION DEVICE SET	231-53
INJECTOR MECHANICAL-HYDRAULIC EXTRACTOR 12T	219	PNEUMATIC INSPECTION DEVICE TO TEST INSULATING GLOVES	27
INJECTOR EXTRACTOR		INSULATING	
INJECTOR EXTRACTOR MAN	222	4 INSULATION CAPS	27
INJECTOR EXTRACTOR RENAULT/NISSAN/OPEL 2.0-2.2-2.5 DCI	219	CLASS 3 INSULATING MAT - 100x60cm	27
SLIDE HAMMER FOR INJECTOR SEALS Ø3.5-15.5mm L.440mm	223	INSULATING RESCUE ROD L.147cm	29
INJECTOR GASKET		INSULATING SHEET 3/10th 12.5x1.3m	29
SLIDE HAMMER FOR INJECTOR SEALS Ø3.5-15.5mm L.440mm	223	INTERCHANGEABLE	
INJECTOR HOLDER		PISTON PUSHER FOR PAIRED BRAKES WITH INTERCHANGEABLE PLATES	255
LCV/HGV INJECTOR-HOLDER REMOVAL WRENCH	216	TIE-ROD ASSEMBLER/REMOVER Ø30-Ø45mm WITH INTERCHANGEABLE HEADS 4PCS	268
INJECTOR HOLDER SOCKET		INTERFACE	
1/2" D. SOCKET SET FOR INSTALLING/REMOVING INJECTOR HOLDERS	216	3 FLEXIBLE INTERFACES Ø150/10mm	337-87
INJECTOR LINER		3 FLEXIBLE INTERFACES Ø150/5mm	337-87
INJECTOR LINER APPLICATION TOOL HPI SCANIA	222	IRON	
INJECTOR LINER APPLICATION TOOL PDE SCANIA	222	PORTABLE GAS SOLDERING IRON	21-328
INJECTOR LINER APPLICATION TOOL VOLVO/RENAULT 7-9L	222	IRP END	
INJECTOR LINER APPLICATION TOOL VOLVO/RENAULT FH-FM	222	10 IRP ENDS 6mm PASSAGE FEMALE 1/4"	69-70-75
INJECTOR LINER APPLICATION TOOL XPI SCANIA	222	10 IRP ENDS 6mm PASSAGE FEMALE 3/8"	75
INJECTOR PULLER		10 IRP ENDS 6mm PASSAGE FOR HOSES	71-75
INJECTOR PULLER VOLVO/RENAULT/MAN/DAF	220	10 IRP ENDS 6mm PASSAGE MALE 1/4"	75
		10 IRP ENDS 6mm PASSAGE MALE 3/8"	75

INDEX • THEMATIC

10 IRP ENDS 8mm PASSAGE FEMALE 1/2"	75	LEAK DETECTION	
10 IRP ENDS 8mm PASSAGE FEMALE 1/4"	75	NEUTRAL PH AEROSOL LEAK DETECTOR	247
10 IRP ENDS 8mm PASSAGE FEMALE 3/8"	75	LEAK DETECTOR	
10 IRP ENDS 8mm PASSAGE FOR HOSES	75	AIR CONDITION R1234 YF CONTROL SET BY TRACER	246
10 IRP ENDS 8mm PASSAGE MALE 1/2"	75	AIR CONDITION R134 CONTROL SET BY TRACER	246
10 IRP ENDS 8mm PASSAGE MALE 1/4"	75	ELECTRONIC STETHOSCOPE LEAK DETECTOR	247-362
10 IRP ENDS 8mm PASSAGE MALE 3/8"	75	NITROGEN/HYDROGEN LEAK KIT (N2-H2) 50bars	248
JACK		UNIVERSAL ELECTRONIC LEAK DETECTOR R134/1234YF/HYDROGEN	248
AIR HYDRAULIC JACK 10-22-40T	164	LEAK DETECTOR TESTER	
AIR HYDRAULIC JACK 15-30-50T	165	UNIVERSAL CYLINDER LEAK DETECTOR TESTER	228
AIR HYDRAULIC JACK 15-30T	164	LEAK SEALANT	
ALUMINUM FLOOR JACK 1.25T 85mm	160	RADIATOR LEAK SEALER 300ml	201
BRAKE DISC EXTRACTION JACKS	263	LEAK STOP	
EXTRA LONG HANDLE FOR PNEUMATIC JACK	158	300 ml ENGINE LEAK STOP	225
EXTRA LOW PROFILE SERVICE GARAGE JACK 2.5T 75mm	161	AIR CONDITIONING LEAK STOP 30g	247
GARAGE FOOT PEDAL FLOOR JACK 3T	161	LETTER PUNCH	
HIGH ELEVATION HYDRAULIC FLOOR JACK 3T	159	27 LETTER PUNCH SET DIN 10mm	148-376
HIGH LIFT AIR HYDRAULIC JACK 30T	165	27 LETTER PUNCH SET DIN 8mm	148-376
HYDRAULIC FLOOR JACK 2T 85mm	159	LEVER	
LONG CHASSIS SERVICE JACK 10T L.1637mm	163	4 LEVER SET WITH STRIKE DISK	149
LONG CHASSIS SERVICE JACK 5T L.1505mm	163	INJECTOR EXTRACTION LEVER M12x1.00 MALE	218
PNEUMATIC FLOOR JACK 2T-2 STAGES	158	INJECTOR EXTRACTION LEVER M12x1.5 FEMALE	218
PNEUMATIC FLOOR JACK 2T-3 STAGES	158	NEUTRAL POSITION ADJUSTMENT TOOL FOR ZF AS TRONIC GEAR-BOX	235
SERVICE GARAGE JACK 2.25T	160	LIFT	
SERVICE GARAGE JACK 2T	159	2 COLUMNS ASYMETRIC POST LIFT 4T COMFORT LIFT 2.50	316
SERVICE GARAGE JACK 3T 95mm	161	2 COLUMNS ASYMETRIC POST LIFT 4T COMFORT LIFT 2.50X	316
JACK STAND		4 MOBILE HGV LIFT COLUMNS 5.5T RG5.5-4 WIRE CONNECTION	317
PAIR OF 10T JACK STANDS WITH SECURITY PIN	155	6 MOBILE HGV LIFT COLUMNS 5.5T RG5.5-6 WIRE CONNECTION	318
PAIR OF 2T JACK STANDS WITH SECURITY PIN	155	6 MOBILE HGV LIFT COLUMNS 7.5T RG7.5-6 WIRE CONNECTION	318
PAIR OF 3T JACK STANDS WITH SECURITY PINS	155	LIFTING JACK	
PAIR OF 6T JACK STANDS WITH SECURITY PINS	155	1T LOW PROFILE FOLDABLE CRANE	154
JAW		2T FOLDABLE CRANE	154
2 JAW 150mm SET	41	LINE CUTTER	
2 JAW 200mm SET	41	2-HANDLE LINE CUTTER KIT	359
150mm 2 RUBBER COATING MAGNETIC JAW SET	41	LINER	
200mm 2 RUBBER COATING MAGNETIC JAW SET	41	CYLINDER LINER APPLICATION TOOL 60-160mm	228
ARTICULATED UPPER JAWS	272-273	LIQUID DISTRIBUTION HOSE	
JIGS		FLUID EXTRACTOR/DISPENSER	172-199
2 ADJUSTMENT JIGS FOR SCANIA PUMP INJECTORS	221	LIQUID SUCTION HOSE	
JOINT		FLUID EXTRACTOR/DISPENSER	172-199
BLACK SEALANT CARTRIDGE -40/+250 DEGREES 200ml	225-49	LOAD BALANCER	
KEY		LOAD BALANCER 680kg	153
9 PCS SPHERICAL HEX KEY SET H1,5-10	108-140	LOCK PLIERS	
SPHERICAL HEX KEY	140	16 PACK LOCK GRIP PLIERS	325
KNIFE		LOCK GRIP PLIER	325
LONG UTILITY KNIFE	356-51	LOCKING TOOL	
PLASTIC CHISEL	308-349	OUTPUT FLANGE LOCKING TOOL FOR VOLVO/RENAULT GEARBOX	238
RETRACTABLE UTILITY KNIFE	356-51	LONG FLEXIBLE SHAFT	
SCRAPER AND UTILITY KNIFE SET	355-51	LONG FLEXIBLE MAGNETIC SHAFT	54
LAMP		MAGNETIC PICK UP TOOL Ø5mm L.1070mm	54
HEADLAMP MAGNETIC SUPPORT RECHARGEABLE 480Lm	17	MAGNETIC PICK UP TOOL Ø5mm L.525mm	54
PORTABLE CAGE LIGHT	14	LONG-NOSED PLIERS	
RECHARGEABLE ALUMINUM RAMP 32 LED IK07	17	LONG-NOSED PLIERS L.200mm	132
ULTRATHIN CORDLESS RECHARGEABLE LAMP WITH VARIABLE INTENSITY 7W IK07	13	LOW PRESSURE GAUGE	
ULTRATHIN CORDLESS RECHARGEABLE LAMP WITH VARIABLE INTENSITY RED	13	ADBLUE + LOW PRESSURE GAUGE SET	192
UV MINI RECHARGEABLE INSPECTION LAMP	16-246	LPG	
LAPPING TOOL		LPG DETECTION KIT	194
2 VALVE LAPPING TOOL SET	229	LUBRICANT	
LEAK		CLEANER/LUBRICANT SPRAY FOR PNEUMATIC TOOLS	78
ELECTRONIC STETHOSCOPE LEAK DETECTOR	247-362	LUBRICANT SILICONE UNIVERSAL SPRAY 500ml	48

LUBRICANT TEFLON SPRAY 500ml	48	7 PCS TORX SCREWDRIVER INSERT T10-40	137
SPECIAL SYNTHETIC OIL FOR SCREW COMPRESSORS (5L)	59-60	8 PCS SCREWDRIVER INSERT	136
SPECIALIST SYNTHETIC OIL FOR PISTON COMPRESSORS (2L)	61	PERFORATED PANEL TOOL RACK 500x900x30mm	39
UNIVERSAL AIR CONDITIONING LUBRICANT BOTTLE 1L PAG	247		
LUG SOCKET		MORTICE CHISEL	
4-LUG SOCKET 1" FOR INTERNAL NUT SCANIA BOX	239	MORTICE CHISEL	149
4-LUG SOCKET 1/2" FOR DELAYING SCANIA (TYPE 1&2)	239	MOUNTING CLIP	
4-LUG SOCKET 3/4" FOR SCANIA GEARBOXES WITHOUT DELAYER	239	SET OF 6 SYNCHRO MOUNTING CLIPS. REDUCING GROUP FOR ZF AS TRONIC GEARBOX	237
4-LUG THIN SOCKET 3/4" FOR SCANIA GEARBOXES WITH DELAYER	239		
MAINTENANCE		MULTIBIT SCREWDRIVER	
CLEANER/LUBRICANT SPRAY FOR PNEUMATIC TOOLS	78	RATCHET SCREWDRIVER 6 BITS	141
MAINTENANCE R1234YF AIR CONDITIONING		MULTIFUNCTIONAL	
AIR CONDITIONING MAINTENANCE KIT R1234YF	251	MULTIFUNCTIONAL FOLDING WORKSHOP TROLLEY 150kg	323-42
MANUAL PUMP		MULTIMETER	
10T 1/4" HAND PUMP	342	DIGITAL MULTIMETER CAT. III	22
4T 1/4" HYDRAULIC HAND PUMP	342	DIGITAL MULTIMETER CAT.I	22
		MULTIFUNCTION TESTER 0-50V	20
		MULTIMETER MEGOHMETRE AND INSULATION TESTER 1000V CAT. III	26
MARKER		MULTIPLIER	
WHITE WASHABLE MARKER FOR ALL SURFACES	346	TORQUE MULTIPLIER R1:58 4800Nm+6 SOCKETS + 2 ADAPTERS 1" HG	126-287
MARKING		NEUTRAL POSITION	
MARKING/WORK AREA SIGNALING PACK	28	NEUTRAL POSITION ADJUSTMENT TOOL FOR ZF AS TRONIC GEAR-BOX	235
MASK		NITROGEN	
FACIAL PROTECTION SCREEN FOR ELECTRICAL ARCS	27	2.2kg NITRO-TRACE CYLINDER (N2-H2)	248
MASTIC		NOZZLE	
GLUE AND WHITE MASTIC CARTRIDGE 310ml	334-49	12 CRIMPING NOZZLES 6-12mm Ø15x1,5mm L.100mm	366
MASTIC BAR TO MODEL METAL REPAIR 57g	327-49	12 TAPERED NOZZLES Ø15x1,5mm L.105mm	366
		12 V-SHAPED NOZZLES 10mm Ø15x1,5mm L.58mm	366
MAT		BAG OF 3 NOZZLES	326
CLASS 3 INSULATING MAT - 100x60cm	27	CERAMIC NOZZLE	332-93
MEASUREMENT		NOZZLE HOLDER	326
COMPRESSION MEASURING KIT FOR DIESEL ENGINES	227	STRUCTURAL GLUE MIXING NOZZLE	49
FEELER GAUGE SET	231-53	Ø1.2mm NOZZLE	339-92
		Ø1.4mm NOZZLE	339-92
		Ø1.6mm NOZZLE	339-92
		Ø2mm NOZZLE	339-92
MECHADRAULIC		NOZZLE WINDSCREEN WASHER CLEANING	
GO-THROUGH MECHADRAULIC CYLINDER 12T+ADAPTERS	279	WINDSCREEN WASHER NOZZLE CLEANING TOOL	358
MEGOHMETER		NUMBER PUNCH	
MULTIMETER MEGOHMETRE AND INSULATION TESTER 1000V CAT. III	26	9 LETTER PUNCH SET DIN 10mm	148-376
METAL REPAIR		9 LETTER PUNCH SET DIN 8mm	148-376
MASTIC BAR TO MODEL METAL REPAIR 57g	327-49	NUT	
		QUICK NUT INTENSIVE USE Ø40x4mm	313-314
MICROMETER		NUT SPLITTER	
EXTERNAL MICROMETER 0-25mm	230-52	NUT SPLITTER	271
MICROMETER 25-50mm	230-52	OIL	
MINERAL OIL		2 BRAKE OIL RECOVERY JERRYCANS	257
MINERAL/MULTIGRADE OIL ELECTRIC CLUTCH BLEEDER 5-20L 3.5bar	233	24L SUCTION DRAINER	199
MINI LAMP		2L CAN OF SPECIALIZED OIL	214
RECHARGEABLE PORTABLE ARTICULATED LIGHT IK08	12	30 MULTI-BRAND CAP OIL FILTER SET	196
MIRROR		70L GREY WASTE OIL DRAINER	198
TELESCOPIC MIRROR 228mm-715mm	54	80I MIXED WASTE OIL DRAINER	198
MIXING		80I MIXED WASTE OIL DRAINER WITH BOWL	198
STRUCTURAL GLUE MIXING NOZZLE	49	80I WASTE OIL DRAINER	198
MOBILE HGV WHEEL BALANCER		ADJUSTABLE PLIER FOR OIL FILTERS HG	195
MOBILE HGV WHEEL BALANCER W102	311	MOBILE OIL DISTRIBUTION BARREL 180-220kg	173
MOBILE SUPPORT WHEEL		OIL FILTER WRENCH Ø107mm 15-SIDED	195
PAIR OF ALUMINUM ROLLERS	322	OIL FILTER WRENCH Ø137mm 18-SIDED	190
MODULE		OIL SUMP REPAIR KIT WITH PLUGS	197
17 PCS COMBINATION WRENCH INSERT 6-24mm	129	SPECIAL SYNTHETIC OIL FOR SCREW COMPRESSORS (5L)	59-60
23 PCS 1/2" RATCHET INSERT	114	SPECIALIST SYNTHETIC OIL FOR PISTON COMPRESSORS (2L)	61
4 PCS COMBINATION WRENCH INSERT 27-32mm	129		
43 PCS SPECIAL BIT INSERT	143		
59 PCS RATCHET INSERT 1/4"	108		
7 PCS HEX T-HANDLE WRENCH INSERT 3-10mm	138		
7 PCS T-HANDLE WRENCH INSERT TORX T10-T40	139		
7 PCS T-HANDLE WRENCH SET TORX T10-T40	139		

INDEX • THEMATIC

UNIVERSAL AIR CONDITIONING LUBRICANT BOTTLE 1L PAG	247	PIT JACK 1T	162
OIL DISTRIBUTION		PIT JACK 300kg	162
DIGITAL VOLUMETRIC GUN 1/2" OIL/ANTIFREEZE	173-73	PIT JACK 600kg	162
OIL DISTRIBUTOR		PITCHER	
OIL DISTRIBUTOR REMOVAL WRENCH VT VOLVO/RENAULT GEAR-BOX	238	2L GRADUATED PITCHER	171
OIL SUCTION DRAINER		5L GRADUATED PITCHER	171
24L SUCTION DRAINER	199	PITMAN ARM PULLER	
OILER		BENZ ACTROS PITMAN ARM PULLER Ø42mm	267
OILER	76	PLASMA	
ORBITAL SANDER		BAG OF 10 ELECTRODES	326
ELECTRIC ORBITAL SANDER Ø150mm	337	BAG OF 2 DIFFUSERS	326
OSCILLOSCOPE		BAG OF 3 NOZZLES	326
OSCILLOSCOPE	24	CENTRAL PLASMA CUTTING UNIT	326
OVERHANG		CONNECTABLE PLASMA CUTTER 40A	326
METAL TRAY 662x340mm	97	NOZZLE HOLDER	326
OVERLOAD CIRCUIT BREAKER		PLASMA CUTTER TORCH	326
OVERLOAD CIRCUIT BREAKER 12-24V	326	PLASMA CUTTER	
PAD		BAG OF 10 ELECTRODES	326
RECTANGULAR RUBBER PAD	168	BAG OF 3 NOZZLES	326
REINFORCED ROUND RUBBER PAD (2 METALLIC WASHERS) Ø120x32mm	167	NOZZLE HOLDER	326
REINFORCED ROUND RUBBER PAD (METALLIC PLATE)	168	PLASMA CUTTER TORCH	326
ROUND RUBBER PAD	166-167	PLASTIC REPAIR	
PAINT		AEROSOL COOLANT FOR PLASTIC REPAIRS	373
HVLP PROFESSIONAL SPRAY PAINT GUN	339-92	HOT STAPLER	374
MINI PROFESSIONAL SPRAY GUN HVLP	339-92	PLASTIC REPAIR COMPOSITION KIT	372
PAINTWORK		PLASTIC REPAIR KIT	373
MAGNETIC PAINTWORK SUPPORT FOR REAR PARKING SENSOR L.500mm	371	PLATFORM	
PAINTWORK SUPPORT STRUCTURE		MEDIUM MULTI-HOLE VELCRO® TRAY Ø150mm/8mm	337-87
MAGNETIC PAINTWORK SUPPORT WITH PLIERS	339	PLATFORM RAMP	174
PANEL		ROLL PLATFORM FOR BEAD BREAKER	306
BAG OF 10 DOUBLE HOOKS Ø6mm L.100mm	101-39	SPILL CONTAINMENT TRAY 110L	174
BAG OF 10 DOUBLE HOOKS Ø6mm L.50mm	101-39	SPILL CONTAINMENT TRAY 230L	174
BAG OF 10 SIMPLE HOOKS Ø6mm L.50mm	101-39	UNIVERSAL DEVICE TABLE REDUCER 5"-23" Ø75mm VELCRO SANDING PAD	308
PERFORATED PANEL TOOL RACK 500x900x30mm	39		89
PEN		PLATFORM RAMP	
STRAIGHT BLOWGUN PEN	340-69-76	PLATFORM RAMP	174
PENCIL		PLIER	
6 CRAYON SET	215	2 SPACER PLIERS GEARBOX COVER	238
PENTAGONAL WRENCH		4 PLIERS SET	132
3 PENTAGONAL WRENCH SET	254	PLIER TRIM CLIP	
PIPE		TRIM CLIP PLIER	349
ASSORTED POPULAR BRAKE LINE FITTINGS BOX 135 PCS	260	PLIERS	
DIN/SAE BRAKE LINE REPAIR KIT	259	4 PCS PLIER INSERT	132
MANUAL BRAKE LINE BENDER Ø3-Ø4-Ø6mm	260	BRAKE PLIERS HGV L.520mm OPENING 210mm	253
PIPPING VALVE		MULTIFUNCTIONAL TIRE PLIERS	314
PIPPING VALVE	65	SPRING CLIP FOR INSULATING SHEET	28
PISTON		VALVE CUTTING PLIERS	308
23 PCS PNEUMATIC BRAKE CALIPER REWIND SET	255	PLUG	
PISTON PUSHER		5 PLUG SET FOR BRAKE/CLUTCH BLEEDERS	258
23 PCS PNEUMATIC BRAKE CALIPER REWIND SET	255	HGV MAN TGA PLUG SET	233
37 PCS BRAKE PISTON PUSHER SET	255	HGV MERCEDES PLUG SET	233
PISTON PUSHER FOR PAIRED BRAKES WITH INTERCHANGEABLE PLATES	255	VALVE/CONNECTOR/PLUG AIRCON MAINTENANCE SET	251
PIT		PNEUMATIC	
65L HGV PIT COLLECTOR	199	MICROGRAIN PNEUMATIC SANDBLASTING BOOTH	93
HGV FLUID COLLECTION CONTAINER 65L	199	PNEUMATIC GUN FOR 370mm CARTRIDGES AND BAGS	366-90
PIT PROTECTION COVER REEL 20m	29-72	PNEUMATIC VACUUM BRAKE BLEEDER	258
PIT JACK		PRO SPRAY GUN	178-353-94
2 STAGE PIT JACK 1.5T	234	SANDBLASTING GUN	333-94
2 STAGE PIT JACK 800kg	234	Ø10mm REVERSIBLE DRILL	376-81
		Ø13mm REVERSIBLE DRILL	81

PNEUMATIC DRILL		PLASTIC PRIMARY SPRAY 400ml	370
Ø10mm REVERSIBLE DRILL	376-81	WHITE FILLER PRIMER 500ml	338
Ø13mm REVERSIBLE DRILL	81	PRIMING	
PNEUMATIC GUN		MANUAL PRIMING PUMP WITH TAPPET	170
PRO SPRAY GUN	178-353-94	PRINTER	
SANDBLASTING GUN	333-94	PRINTER	240
PNEUMATIC KNIFE		PRINTER PAPER ROLL	
PNEUMATIC KNIFE	362-84	2 PAPER ROLL SET	240
PNEUMATIC PUMP		PROTECTION	
PNEUMATIC OIL PUMP+SUCTION TUBE FOR 180-220kg DRUMS	173	KIT OF 4 WINDSCREEN PROTECTORS	361
POLARITY		PIT PROTECTION COVER REEL 20m	29-72
POLARITY/CONTINUITY TESTER 3 TO 48V	22	PROTECTIVE SHEATH	307
POLISHER		PROTECTIONS IMPACT SOCKET	
3" MINI POLISHER KIT Ø75mm	370-89	3 PLASTIC PROTECTIONS FOR IMPACT SOCKET 1/2"	115
VERTICAL POLISHER Ø150mm	337-89	PULLER	
PORTABLE LIGHT		BEARING PULLER FOR GEARBOXES ZF SET	237
360° IK07 MINI LAMP	16	BEVEL BEARING GEAR PULLER FOR ZF AS TRONIC GEARBOXES	237
48 LED RAMP	14	UNIVERSAL HGV HUB PULLER (5 ARMS)	284
GLASS COVER	14-15	PULLEY	
MINI RECHARGEABLE INSPECTION LAMP 3W COB+ISMD	16	UNIVERSAL BELT PULLEY PULLER QUICK APPROACH Ø47-110mm	213
NEON PORTABLE LIGHT	14	PULLEY DISMANTLING ALTERNATOR	
PORTABLE CAGE LIGHT	14	30PCS FREEWHEELING ALTERNATOR PULLEY DISMANTLING KIT	213
RECHARGEABLE PORTABLE LIGHT 6W COB IK07	11	PULLEY EXTRACTOR	
ULTRATHIN CORDLESS RECHARGEABLE LAMP WITH VARIABLE INTENSITY	13	UNIVERSAL BELT PULLEY PULLER QUICK APPROACH Ø47-110mm	213
UV MINI RECHARGEABLE INSPECTION LAMP	16-246	PULLING	
WIRED 30 LED PORTABLE LAMP	14	12 PCS PULLING END SET	346
WIRED FLUORESCENT PORTABLE LAMP	15	PULLING HANDLES	
POST LIFT		PAIR OF PULLING HANDLES	359
2 COLUMNS ASYMETRIC POST LIFT 4T COMFORT LIFT 2.50	316	PUMP	
2 COLUMNS ASYMETRIC POST LIFT 4T COMFORT LIFT 2.50X	316	18T HYDRAULIC EXTRACTION PACK + HYDRAULIC AIR PUMP/HOSE/CONNECTOR	278
PPE		18T HYDRAULIC PRESS PACK + HYDRAULIC AIR PUMP/HOSE/CONNECTOR	277
PERSONAL ELECTRICAL PROTECTION EQUIPMENT SET	27	HYDRAULIC PUMP 24V 0-40bar	270
PRECISION		MANUAL PRIMING PUMP WITH TAPPET	170
STRAIGHT EDGE FOR CHECKING CYLINDER HEAD FLATNESS	230	METAL TRANSFER PUMP	170
PRESS		PUMP	181
18T HYDRAULIC EXTRACTION PACK + HYDRAULIC AIR PUMP/HOSE/CONNECTOR	278	TRANSFER PUMP 12V	171
18T HYDRAULIC PRESS PACK + HYDRAULIC AIR PUMP/HOSE/CONNECTOR	277	PUMP INJECTOR CALIBRATION	
PUNCHER TOOLS	152	600bar PUMP FOR INJECTOR CALIBRATION	214
DUAL-CONTROL HYDRAULIC PRESS SLIDING CYLINDER	151	PUMP PRESSURE VACUUM	
HYDRAULIC PRESS 20T	150	METAL PRESSURE AND VACUUM PUMP (-1/+ 4bar)	258
HYDRAULIC PRESS TOOL SET 18T	276	PUNCH	
HYDRAULIC PUMP WITH FRAME AND SPINDLES	277	20T PUNCHER TOOLS	152
SWIVEL PRESS 100T+PUNCHES	270-281	30T PUNCHER TOOLS	152
UNIVERSAL 20-30T PRESS SUPPORT STRUCTURE	152	4 PCS HGV PUNCH SET	149
PRESS SOCKET		5 PUNCH SET WITH INSERTED BLADE	149
20 LARGE Ø SOCKET SET	279	50T PUNCHER TOOLS	152
PRESSURE		6 PIN DRIVER SET WITH BASE	149
BRAKE & ABS PRESSURE GAUGE SET	252	AUTOMATIC PUNCH	149
PRESSURE VACUUM PUMP		RETRACTABLE PROBES	23
METAL PRESSURE AND VACUUM PUMP (-1/+ 4bar)	258	PUNCH TOOL	
PRIMARY SHAFT		REAR PARKING SENSOR PUNCH TOOL Ø24mm	371
INSTALLATION/REMOVAL PRIMARY SHAFT ZF AS TRONIC GEARBOX	237	REAR PARKING SENSOR PUNCH TOOL Ø27mm	371
PRIMARY SHAFT POSITIONING TOOL ZF AS TRONIC GEARBOX	237	REAR PARKING SENSOR PUNCH TOOL Ø30mm	371
PRIMARY SHAFT SUPPORT FOR ZF ECOSPLIT GEARBOX	235	REAR PARKING SENSOR PUNCH TOOL Ø32mm BMW/VAG/OPEL	371
PRIMARY/SECONDARY SHAFT UNLOCKING TOOL FOR ZF16 ECOSPLIT GEARBOX	236	PUNCHING	
PRIMER		REAR PARKING SENSOR PUNCH TOOL KIT Ø17-Ø22mm	371
BLACK FILLER PRIMER 500ml	338	PURGER	
DARK GREY GARNISHING PRIMER 500ml	338	12 BRAKE BLEEDER PLUG SET	256
LIGHT GREY FILLER PRIMER 500ml	338	PNEUMATIC VACUUM BRAKE BLEEDER	258

INDEX • THEMATIC

QUICK CONNECTOR		RATCHET SCREWDRIVER	
FAST CONNECTOR PASSAGE 6mm FEMALE"	75	RATCHET SCREWDRIVER 6 BITS	141
FAST CONNECTOR PASSAGE 6mm FOR HOSES Ø8mm	75	RATCHET WRENCH	
FAST CONNECTOR PASSAGE 6mm MALE	75	1/2" D. RATCHET WRENCH	78
FAST CONNECTOR PASSAGE 7.2mm FEMALE	74	3/8" D. RATCHET WRENCH	77
FAST CONNECTOR PASSAGE 7.2mm FOR HOSES	74	REAMER	
FAST CONNECTOR PASSAGE 7.2mm MALE	74	10mm 5 CARBIDE ROTARY RASPS BOX	330-44
FAST CONNECTOR PASSAGE 8mm FEMALE	75	CARBIDE REAMER 8.3x47mm	328-81
FAST CONNECTOR PASSAGE 8mm FOR HOSES	75	REAR PARKING SENSOR	
FAST CONNECTOR PASSAGE 8mm MALE	75	REAR PARKING SENSOR PUNCH TOOL	371
FILTRATION AIR CONDITIONING		REAR PARKING SENSOR PUNCH TOOL Ø32mm BMW/VAG/OPEL	371
DETECTION KIT / AIR CONDITIONING IMPURITIES FILTRATION SYSTEM R1234YF	249	REAR SENSORS	
DETECTION KIT / AIR CONDITIONING IMPURITIES FILTRATION SYSTEM R134	249	REAR PARKING SENSOR PUNCH TOOL KIT Ø17-Ø22mm	371
RADIATOR		RECHARGEABLE	
BUSES RADIATOR CRANE	200	1/2" RECHARGEABLE IMPACT WRENCH 600Nm	315-79
RADIATOR LEAK SEALER 300ml	201	1/2" RECHARGEABLE IMPACT WRENCH 600Nm+ADDITIONAL BATTERY	79
RADIATOR SUPPORT		4.0Ah LI-ION BATTERY	79
BUSES RADIATOR CRANE	200	RECHARGEABLE LAMP	
RAMP		ULTRATHIN CORDLESS RECHARGEABLE LAMP WITH VARIABLE INTENSITY 7W IK07	13
INSTALLATION AND REMOVAL ROCKER ARM RAMP TOOL IVECO 10-13L	206	ULTRATHIN CORDLESS RECHARGEABLE LAMP WITH VARIABLE INTENSITY RED	13
INSTALLATION AND REMOVAL ROCKER ARM RAMP TOOL IVECO 8L	206	RECTANGULAR SOCKET	
INSTALLATION AND REMOVAL ROCKER ARM RAMP TOOL RENAULT/VOLVO 9-12-16L	204	RECTANGULAR HUB SOCKET FOR KASSBOHRER/SETRA/DAF/MERCEDES 56x71mm	293
MAGNETIC PAINTWORK SUPPORT FOR REAR PARKING SENSOR L.500mm	371	RECTANGULAR HUB SOCKET MAN/MERCEDES 60x76mm	290
RECHARGEABLE ALUMINUM RAMP 32 LED IK07	17	RECTIFIER	
RASP		BRAKE HOSE RECTIFIER	260
10mm 5 CARBIDE ROTARY RASPS BOX	330-44	REDUCER	
RATCHET		1"x3/4" REDUCER	121-124
1" EXTENSION	126	1/2"D. x 3/8"D. REDUCER	109
1" PAWL REPAIR KIT	127	3/4"D. x 1/2"D. REDUCER	121
1" RATCHET	126	REEL	
1/2 " RATCHET REPAIR KIT 72 TEETH	114	AIR REEL Ø10mm 16m	70
1/2" EXTENSION	114	AIR REEL Ø8mm 16m	70
1/2" PAWL REPAIR KIT	127	GREASE HOSE REEL Ø8mm 20m 350bar	173-73
1/2" RACHET 72 TEETH	114	HGV AIR REEL Ø13mm 20m	71
1/2" SLIDING T-HANDLE	114	HIGH PRESSURE AIR/WATER REEL Ø10mm 20m 280bar	72
1/4 " RATCHET REPAIR KIT 72 TEETH	108	MOBILE ELECTRICAL REEL 3x2.5mm2 20m	66
1/4" EXTENSION	108	MOBILE ELECTRICAL REEL 3x2.5mm2 40m	66
1/4" RATCHET 72 TEETH	108	OIL REEL Ø10mm 15m 153bar	73
1/4" SLIDING T HANDLE	108	PIT PROTECTION COVER REEL 20m	29-72
1/4"-1/2" US-INCH (52 PCS) COMPOSITION BOX SET	116	REEL 3x2.5mm2 20m	68
1/4"-3/8" D. MINI RATCHET WRENCH KIT	77	REFRACTOMETER	
1/4"FLEXIBLE EXTENSION	108	REFRACTOMETER	192-201
23 PCS 1/2" RATCHET INSERT	114	REFURBISHMENT	
3/4" PAWL REPAIR KIT	127	10 PCS REPAIR TOOL SAE MALE/FEMALE SET	259
3/4" RATCHET	123	3/16" ADAPTER	259
3/8" EXTENSION	110	DIN/SAE BRAKE LINE REPAIR KIT	259
3/8" PAWL REPAIR KIT	127	METRICAL INNER/OUTER THREAD FILE 0.8-3.0	45
3/8" RATCHET 72 TEETH	110	WHEEL STUD THREAD RESTORER HGV	285
3/8" RATCHET INSERT 21 PCS	110	RELAY	
3/8" SLIDING T-HANDLE	110	12V RELAY TESTER	19
59 D. SOCKET SET 1/4"	109	90° ELBOW NOSE PLIERS	19
59 PCS RATCHET INSERT 1/4"	108	STRAIGHT NOSE PLIERS	19
94 D. SOCKET SET 1/4"-1/2"	112	RELAY TESTER	
CV JOINT	114	12V RELAY TESTER	19
RATCHET HANDLE + 11 HEX SOCKETS 1" D. FOR HGV 36-80	126	RELEASER	
RATCHET+10 DOUBLE HEX SOCKET SET 3/4" D. 22-50mm	123	INJECTOR/GLOW PLUG RELEASER 500ml	215
RATCHET+10 HEX SOCKET SET 3/4" D.	123	RELEASING	
RATCHET+8 HEX SOCKET SET 1" D.	126	SUPER RELEASING GRAPHITE SPRAY 400ml	283-47

REMOVER		ROCKER ARM	
3 BALL JOINT PULLER SET Ø23 TO Ø34mm	266	INSTALLATION AND REMOVAL ROCKER ARM RAMP TOOL IVECO 10-13L	206
BALL JOINT PULLER	266	INSTALLATION AND REMOVAL ROCKER ARM RAMP TOOL IVECO 8L	206
BALL JOINT SEPARATOR Ø18mm	266	INSTALLATION AND REMOVAL ROCKER ARM RAMP TOOL RENAULT/VOLVO 9-12-16L	204
EXPRESS PAINT REMOVER SPRAY 500ml	182-334-338-47	ROD	
HYDRAULIC BALL JOINT PULLER KIT Ø30-34-40mm	266	14 PCS BODYWORK ROD SET	344
KNIVES + CLAWS SEPARATOR SET	282	9 DOOR OPENING SET	348
MULTI-BRAND HUB PULLER (CARS & LCV)	284	INSULATING RESCUE ROD L.147cm	29
WINDSCREEN WIPER REMOVER	358	U-SHAPED SEMI-RIGID ROD TO HOOK DOOR HANDLES 1.50m	348
REPAIR AUTO DENT		ROD MOUNT	
AUTO DENT REPAIR KIT WITH SLIDE HAMMER	345	SUCTION CUP SUPPORT RODS Ø120mm CAPACITY 20kg	344
REPAIR WINDSHIELD		ROLL	
WINDSHIELD REPAIR CASE	357	DISPENSER/HAND TOWEL ROLL STAND FOR DRAWERS	101
REPLACEMENT		ROLLER CABINET	
GEARBOX OIL COOLER SUBSTITUTE DAF 105	210-234	3 DRAWER ROLLER CABINET/1 EG 0086 + 119 TOOLS	103
RESERVOIR		4 DRAWERS + 1 DOOR ROLLER CABINET HGV 197 TOOLS	106
PAINTED VERTICAL TANK 500l 11bar	58	7 DRAWERS ROLLER CABINET XL 228 TOOLS	105
PAINTED VERTICAL TANK 500l 16bar	58	ROLLER CABINET TRAY	
RESIN		3 TRAY ROLLER CABINET	40-99
FINISH RESIN 5ml	358	ROPE INSERTION TOOL	
REPAIR RESIN 10ml	358	ROPE INSERTION TOOL	360
RETAINER		ROTARY NOZZLE	
UNIVERSAL 20-30T PRESS SUPPORT STRUCTURE	152	FULL ROTARY NOZZLE	353
RETAINING NUT		SADDLE JOINT	
MEDIUM-STRENGTH THREAD LOCK 10ml	228-50	ANTI GRAVEL MS POLYMER BLACK CARTRIDGE 310ml	333
STRONG THREAD LOCK 10ml	228-50	SAE	
RETHREADING TOOL		10 PCS REPAIR TOOL SAE MALE/FEMALE SET	259
METRICAL INNER/OUTER THREAD FILE 0.8-3.0	45	SAND	
RETRACTABLE		DRUM OF SYNTHETIC SAND 30kg	332
4 COUPLING PUSH BUTTON SET	250	SANDBLASTING	
MANUAL PRIMING PUMP WITH TAPPET	170	HIGH-FLOW SANDING GUN (ceramic nozzle)	332-93
RETRACTABLE TUBING		HIGH-FLOW SANDING GUN (metal nozzle)	332-93
MINI TORCH WITH RETRACTABLE TUBING + GAS REFILL	21	MICROGRAIN PNEUMATIC SANDBLASTING BOOTH	93
RING		SANDER	
5 CENTERING RINGS	314	10mm BELT SANDER	331-88
BOWL/SEAL/RING KIT FOR BALANCERS	313	2.5mm RANDOM ORBITAL PALM SANDER Ø150mm	336-87
CRANKSHAFT FRONT SEAL INSTALLATION TOOL DAF	210	5mm RANDOM ORBITAL PALM SANDER Ø150mm	336-87
CRANKSHAFT FRONT SEAL INSTALLATION TOOL IVECO STRALIS 10L (F2C)	207	ABRASIVE DISC HOLDER TRAY Ø50mm	329-86
CRANKSHAFT FRONT SEAL INSTALLATION TOOL IVECO/ASTRA 10-11-13-16L	207	ELECTRIC ORBITAL SANDER 2.5mm Ø150mm	337
CRANKSHAFT FRONT SEAL INSTALLATION TOOL SCANIA 12L Ø119	208	ELECTRIC ORBITAL SANDER 5mm Ø150mm	337
CRANKSHAFT FRONT SEAL INSTALLATION TOOL SCANIA 9-13L Ø119mm	209	EXHAUST HOSE ASSEMBLY Ø32mm L.170cm	337-87-88
CRANKSHAFT FRONT SEAL INSTALLATION TOOL SCANIA Ø119-138mm	209	MINI ORBITAL SANDER KIT Ø50-75mm	370-89
CRANKSHAFT FRONT SEAL INSTALLATION TOOL SCANIA Ø149mm	209	SANDING STRIP 120	88
CRANKSHAFT REAR SEAL INSTALLATION TOOL IVECO DAILY/FIAT DUCATO	207	SANDING STRIP 80	88
CRANKSHAFT REAR SEAL INSTALLATION TOOL IVECO EUROCARGO 1-3	207	SANDING BELT	
CRANKSHAFT REAR SEAL INSTALLATION TOOL IVECO/ASTRA 10-13L	207	SANDING STRIP 80	88
CRANKSHAFT REAR SEAL INSTALLATION TOOL SCANIA Ø175-185mm	208	SAW	
CRANKSHAFT REAR SEAL INSTALLATION TOOL SCANIA Ø175mm	208	10mm AIR BODY SAW	331-83
CRANKSHAFT REAR SEAL INSTALLATION TOOL SCANIA Ø185mm	208	SAW BLADE	
CRANKSHAFT SEAL INSTALLATION RING SCANIA	208	24-TOOTH BLADE	331-83
PISTON INSERT GUIDE DAF	228	32-TOOTH BLADE	331-83
RIVETER		SAWING WIRE	
AIR RIVETER KIT	375-82	SAWING WIRE 0.8mmx0.8mmx44m	359
RIVETING PLIERS		SCISSORS	
RIVETING PLIERS	375-82	PLASTIC CHISEL	308-349
		SCRAPER	
		100 SCRAPER BLADE SET	355-51
		PLASTIC SCRAPER	355-51
		RETRACTABLE SCRAPER + 100 BLADES	355-51
		SCRAPER AND UTILITY KNIFE SET	355-51

INDEX • THEMATIC

SCRAPER BLADE 8mm	362	2000x175mm SHELF	39
SCRAPER WITH HANDLE	355	SHOCK ABSORBER	
SCRAPER WITH HANDLE + 100 BLADES	355-51	FRONT WHEEL SHOCK ABSORBER SOCKET SCANIA INNER Ø28mm	271
SCRAPER RETRACTABLE		REAR WHEEL SHOCK ABSORBER SOCKET SCANIA OUTER Ø46mm	271
RETRACTABLE SCRAPER	355	REAR WHEEL SHOCK ABSORBER SOCKET SCANIA OUTER Ø56mm	271
SCREEN		REAR WHEEL SHOCK ABSORBER SOCKET VOLVO	271
PERSONAL ELECTRICAL PROTECTION EQUIPMENT SET	27	SHOCK ABSORBER HEAD REMOVAL KIT	275
SCREEN ADHESIVE CARTRIDGE 290ml	365	SHOCK ABSORBER SOCKET	
SCREW EXTRACTOR		FRONT WHEEL SHOCK ABSORBER SOCKET SCANIA INNER Ø28mm	271
SCREW EXTRACTOR SET + HSS DRILLS Ø2-Ø7.5mm	44	REAR WHEEL SHOCK ABSORBER SOCKET SCANIA OUTER Ø46mm	271
SCREWDRIVER		REAR WHEEL SHOCK ABSORBER SOCKET SCANIA OUTER Ø56mm	271
16 PCS IMPACT SCREWDRIVER SET	141-254	REAR WHEEL SHOCK ABSORBER SOCKET VOLVO	271
33 PRECISION SCREWDRIVER + BIT SET	141	SHOCK ABSORBERS	
7 PCS HEX T-HANDLE WRENCH INSERT 3-10mm	138	CABIN SHOCK ABSORBERS ASSEMBLY/DISASSEMBLY PACK	204
7 PCS SCREWDRIVER TORX SET T10-40	137	SHOCK-ABSORBER	
7 PCS T-HANDLE WRENCH INSERT TORX T10-T40	139	CUPS RENAULT TWINGO III (2014)	274
7 PCS T-HANDLE WRENCH SET TORX T10-T40	139	SIGN	
7 PCS TORX SCREWDRIVER INSERT T10-40	137	MARKING/WORK AREA SIGNALING PACK	28
8 PCS SCREWDRIVER INSERT	136	PLASTIC SIGNALING CHAIN YELLOW/BLACK 25m	28
8 PCS SCREWDRIVER SET	136	SIGNAGE BANNER "WORK ZONE BOUNDARY" 100x20cm	28
FLEXIBLE HOSE CLAMP DRIVER 6-7mm	141	YELLOW AND BLACK SIGNPOST Ø40mm	28
MAGNETIC SPRAY CAN AND SCREWDRIVER HOLDER	100	SIGNALING	
PHILLIPS SCREWDRIVER 0x75	136	ADHESIVE SIGNALING AND SAFETY VINYL TAPE 33m W.50mm	28
PHILLIPS SCREWDRIVER 2x125	136	SILENCER	
PHILLIPS TOM THUMB SCREWDRIVER 1x38	136	EXHAUST PNEUMATIC SLEEVE FOR 1/2" AND 3/8" IMPACT WRENCHES	78
SLOTTED SCREWDRIVER	136	EXHAUST PNEUMATIC SLEEVE FOR 3/4" AND 1" IMPACT WRENCHES	80
SLOTTED TOM THUMB SCREWDRIVER 5.5x38	136	SILENT BLOCK	
SOCKET HOLDER SCREWDRIVER 1/4"	108	SILENT-BLOCK STAB. BAR EXTRACTOR Ø70mm MERCEDES ACTROS	279
T-HANDLE WRENCH H3 x 100	138	SILENT-BLOCK UNIVERSAL EXTRACTION KIT	280
T-WRENCH	138	SILENT BLOCK EXTRACTOR	
TORX SCREWDRIVER	137	18T HYDRAULIC EXTRACTION PACK + HYDRAULIC AIR PUMP/HOSE/CONNECTOR	278
SEAL		18T HYDRAULIC PRESS PACK + HYDRAULIC AIR PUMP/HOSE/CONNECTOR	277
17 CRANKSHAFT SEAL INSTALLATION CUPS	212	HYDRAULIC EXTRACTION SET	276
BOWL/SEAL/RING KIT FOR BALANCERS	313	SILENT BLOCK EXTRACTOR SAF Ø158mm	279
GASKET KIT	353	SILENT-BLOCK STAB. BAR EXTRACTOR Ø70mm MERCEDES ACTROS	279
SEAL KIT FOR 0.2L SYRINGE	171	SILENT-BLOCK UNIVERSAL EXTRACTION KIT	280
SEAL KIT FOR 1.5l SYRINGE	171	SILENT-BLOCK	
SPECIAL A/C JOINT SET	251	HGV SILENT-BLOCK PULLER/INSTALLATION SET	280
VALVE/CONNECTOR/PLUG AIRCON MAINTENANCE SET	251	SILENT-BLOCK PULLER	
SEALANT		HGV SILENT-BLOCK PULLER/INSTALLATION SET	280
BLACK SEALANT CARTRIDGE -40/+250 DEGREES 200ml	225-49	SILICONE	
SECURING KIT		LUBRICANT SILICONE UNIVERSAL SPRAY 500ml	48
HYBRID AND ELECTRIC VEHICLES INSULATED TOOLS 1000V	26	SILICONE FREE ASSEMBLY GEL	
SECURITY		SILICONE FREE ASSEMBLY GEL	65
HYBRID AND ELECTRIC VEHICLES SECURITY KIT+PPE	25	SIMULATOR SENSOR	
PPE PACK + 1000V VARIOUS TOOLS	25	SENSOR SIMULATOR	20
SEGMENT		SLEEVE	
PISTON RING COMPRESSOR Ø65-135mm H.100mm	229	COMPOSITE SLEEVE	64
PISTON RING COMPRESSOR Ø90-175mm H.165mm	229	PISTON INSERT GUIDE DAF	228
SENSOR SIMULATOR		SLIDE HAMMER	
SENSOR SIMULATOR	20	BODYWORK SLIDE HAMMER SET	341
SENSORS		SLIDE HAMMER 7.5kg	217
UNIVERSAL NON INTRUSIVE TEST PROBE SET CAT. II	22	UNIVERSAL EXTRACTION KIT BOSCH/DELPHI/DENSO/SIEMENS	218
SEPARATOR KNIFE		SLIDING HANDLE	
KNIVES + CLAWS SEPARATOR SET	282	1/2" SLIDING T-HANDLE	114
SHEATH		3/8" SLIDING T-HANDLE	110
PROTECTIVE SHEATH	307	SOCKET	
SHEET		1" HEX SOCKET	124
INSULATING SHEET 3/10th 12.5x1.3m	29	1/2" D. 58T PRE-CHAMBER SOCKET DIESEL ENGINES	216
SHELF			
1500x175mm SHELF	39		

1/2" TORX SOCKET	111	26 PCS XZN 1/2" SOCKET BIT SET	118
1/2" HEX SOCKET	111	3/4" D. XZN SOCKET BIT M16	121
1/2" TORX PLUS SOCKET	111-112	3/4" D. XZN SOCKET M18	121
1/4" HEX SOCKET	107	3/4" D.TORX SOCKET BIT	121
1/4" LONG HEX SOCKET	107	30 PCS HEX 1/2" SOCKET BIT SET	118
1/4" TORX PLUS SOCKET EPI0	107	32 PCS RIBE 1/2" SOCKET BIT SET	119
1/4"-1/2" US-INCH (52 PCS) COMPOSITION BOX SET	116	32 PCS TORX SOCKET 1/2" BIT SET	118
1/4"TORX PLUS SOCKETS EP 6-7-8-10-11-12 L.25mm	107	38 PCS SOCKET BIT SET	119
16A 24V HYBRA SOCKET	14-15	77 PCS TS-TORX-TORX PLUS SOCKET AND SOCKET BIT SET	144
3/4" DOUBLE HEX SOCKET	121	IMPACT RIBE WRENCH END SET 1/2" D. 78mm M5-M14	120
3/4" HEX SOCKET	121		
3/4" ROLLER BEARING AXLE NUT SOCKET BPW 12T 80mm	296	SOCKET HOLDER	
3/4" ROLLER BEARING AXLE NUT SOCKET BPW 16T HEX	297	3/8" SQUARE BIT HOLDER HEX. 10mm	144
3/4" ROLLER BEARING AXLE NUT SOCKET BPW 6.5/9T 65mm	296	HEX MALE ADAPTOR 1/4"-1/4"SQUARE L.25mm	108-142-144
3/8" HEX SOCKET	110	SOCKET HOLDER SCREWDRIVER 1/4"	108
4-32mm HSS STEP DRILL	44	SOCKET SPANER	
4-PIN MAN TRANSMISSION SOCKET Ø53.5mm	289	SET OF 5 HEX SOCKET SPANNERS	131
4-PIN SCANIA TRANSMISSION SOCKET Ø63-64mm	295	SOCKET SPANNER	
4-PINS REAR HUB SOCKET FORD TRANSIT	288	HEX SOCKET SPANNER	131
59 D. SOCKET SET 1/4"	109	SET OF 12 HEX. SOCKET SPANNERS	131
6 PIN DRIVE AXLE NUT SOCKET MAN TGA Ø118mm	289	SOLDER	
6 PIN DRIVE AXLE NUT SOCKET MAN/MERCEDES Ø101.5mm	291	PORTABLE GAS SOLDERING IRON	21-328
6 PIN REAR AXLE NUT SOCKET BENZ Ø116mm	292	SOLDERING IRON 30W WITH STAND	21-328
6 PIN REAR AXLE NUT SOCKET MERCEDES/MAN Ø101mm	291	SPACER DISK	
6 PIN REAR AXLE NUT SOCKET MERCEDES/MAN Ø87mm	291	LCV CENTERING CONE Ø118-174mm+SPACER DISK Ø40mm KIT	314
77 PCS TS-TORX-TORX PLUS SOCKET AND SOCKET BIT SET	144	SPARK PLUG	
8-SIDED SOCKET Ø116mm RENAULT/VOLVO/DAF	288	3/8" PLUG WRENCH KIT Ø8-9-10-12-14-16mm	244
94 D. SOCKET SET 1/4"-1/2"	112	DIESEL GLOW PLUG KIT	227
AXLE NUT SOCKET IVECO 110mm DOUBLE HEX	294	SPARK PLUG SOCKET	
AXLE TRAILERS NUT SOCKET SAF 85mm HEX	298	3/8" PLUG WRENCH KIT Ø8-9-10-12-14-16mm	244
BIT HOLDER 10mm HEXAGONAL-1/2" SQUARE	143	SPATULA	
EXHAUST PNEUMATIC SLEEVE FOR 1/2" AND 3/8" IMPACT WRENCHES	78	5 PCS NYLON TRIM REMOVAL SET	349
HEXAGONAL SOCKET FOR MERCEDES/EVOBUS DIFFERENTIAL NUTS Ø72mm	290-293	SPECIAL WRENCH NUT TIGHTENING	
HYDRAULIC BRAKE PIPE FLARING TOOL SET DIN/SAE Ø4.75-5-6-8mm	259	SPECIAL WRENCH NUT TIGHTENING Ø16 TO Ø20	65
IVECO AXLE NUT SOCKET 98mm HEX	294	SPECIAL WRENCH NUT TIGHTENING Ø25 TO Ø32	65
LONG BIT 10mm XZN	142	SPECIAL WRENCH NUT TIGHTENING Ø40 TO Ø50	65
MAN/MERCEDES DIFFERENTIAL REAR NUT 6 PIN SOCKET Ø113mm	290	SPHERICAL	
RATCHET HANDLE + 11 HEX SOCKETS 1" D. FOR HGV 36-80	126	T-HANDLE WRENCH	138
RATCHET+10 DOUBLE HEX SOCKET SET 3/4" D. 22-50mm	123	T-WRENCH H10x215	138
RATCHET+10 HEX SOCKET SET 3/4" D.	123	SPI SEAL	
RATCHET+8 HEX SOCKET SET 1" D.	126	BEARING FORK SEAL INSTALLATION/EXTRACTION KIT	152
REMOVAL ELECTRODE SOCKET INJECTORS HPI SCANIA PUMP (BOSCH)	221	SEAL TOOL KIT 24PCS	212
SET 7 SOCKETS TS TIPS 1/4" D. TS10-TS15-TS20-TS25-TS27-TS30-TS40	107	SPIRAL	
SHORT BIT 10mm XZN M7	142	SPIRAL 4000mm Ø42mm	177-350
TIMING TOOL RENAULT/NISSAN/OPEL 1.6-2.0-2.3 DCI-CDTI	205	SPLITTER	
WHEEL CAPSULE AND AXLE NUT SOCKET	298	SPLITTER ADJUSTMENT TOOL FOR ZF ECOSPLIT GEARBOX	235
Ø 46mm SOCKET 1/2" D. 100mm	116	SPLITTER ADJUSTMENT	
SOCKET BIT		SPLITTER ADJUSTMENT TOOL FOR ZF ECOSPLIT GEARBOX	235
1/2" D. HEX SOCKET BIT	117	SPOT DRILL	
1/2" D. HEXAGONAL IMPACT SOCKET BIT	117	OFFSET SWIVEL CLAMP WITH LOCKING SYSTEM	328
1/2" D. IMPACT HEX BIT IMPACT SOCKET SET	120	SPOT DRILL	328-81
1/2" D. RIBE IMPACT SOCKET BIT	117	SPOT REPAIR	
1/2" D. RIBE SOCKET BIT	117	50 PULLING RINGS SET	327
1/2" D. TORX SOCKET BIT	117	50 PULLING STARS SET (5 POINTED)	327
1/2" D. XZN IMPACT SOCKET BIT	117	50 PULLING TRIANGLES SET	327
1/2" D. XZN SOCKET BIT	117	CHARGER FOR SPOTER PULLING RINGS	327
1/4" D. SOCKET BIT	107	LEVER PULLING BY POINT + 2 M5 ROUND ELECTRODES (SA0447)	327
1/4" D. TS45 SOCKET BIT L.37mm	107	M5 ROUNDED ELECTRODE	327
1/4" D. TS50 SOCKET BIT L.37mm	107	PULLING TWISTED 90° RINGS SET	327
		RINGS/TRIANGLES/STARS HOLDER ELECTRODE	327
		SLIDE STRAIGHTENING HAMMER FOR SPOT REPAIRS	327
		SPOT WELD AND DENT PULLER	327

INDEX • THEMATIC

SPOT WELD	
CENTRAL UNIT SPOT WELD AND DENT PULLER	327
SPOUT	
12 CRIMPING NOZZLES 6-12mm Ø15x1,5mm L.100mm	366
12 TAPERED NOZZLES Ø15x1,5mm L.105mm	366
12 V-SHAPED NOZZLES 10mm Ø15x1,5mm L.58mm	366
SPRAY	
AIR CONDITION TRACER SPRAY CLEANER 400ml	249
AIR-CONDITIONING CIRCUIT CLEANER 400ml	249
ANTI STONE-CHIP SPRAY 400ml	334
BODY REPAIR DEGREASING/CLEANING SPRAY 500ml	182-338-346-47
BUMPER STRUCTURING SPRAY MEDIUM GRIT 400ml	373
CARTRIDGE SPRAY GUN (POLYMER MS)	333-91
ELECTRIC SPRAY CLEANER 400ml	24
EXPRESS PAINT REMOVER SPRAY 500ml	182-334-338-47
LUBRICANT SILICONE UNIVERSAL SPRAY 500ml	48
LUBRICANT TEFLON SPRAY 500ml	48
MULTI-FUNCTIONAL GLUE SPRAY 400ml	356-48
NO RUST SPRAY 400ml	331-334-47
PLASTIC PRIMARY SPRAY 400ml	370
RECHARGEABLE SPRAY 650ml	178
SUPER RELEASING GRAPHITE SPRAY 400ml	283-47
TIRE MOUNTING GREASE SPRAY 400ml	309
VARNISH SPRAY 1K 400ml	370
SPRAY GUN	
PRESSURE FOAM SPRAYER 1l	179-352-94
PRESSURE SPRAYER 1l	179-352-94
SPRAYER	
1.5l BLUE PRESSURE SPRAYER	178-354
1.5l RED PRESSURE SPRAYER	178-354
1.7l PRESSURE SPRAYER BRAKE CLEANER	178
SPREADER	
SPREADER PLIERS	342
SPREADER PLIERS	
SPREADER PLIERS	342
SPRING	
BRAKE SPRING TOOL	254
PAIR OF SPRING COMPRESSORS	274
SPRING COMPRESSION TOOL	254
SPRING COMPRESSION	
CUPS RENAULT TWINGO III (2014)	274
SPRING COMPRESSOR	
ARTICULATED UPPER JAWS	272-273
PNEUMATIC SPRING COMPRESSOR 3T	272
SPRING COMPRESSOR 1500kg	274
SPROCKET	
BEVEL BEARING GEAR PULLER FOR ZF AS TRONIC GEARBOXES	237
SQUARED	
RECTANGULAR RUBBER PAD 160x120x115mm	168
STAGES	
PNEUMATIC FLOOR JACK 2T-2 STAGES	158
PNEUMATIC FLOOR JACK 2T-3 STAGES	158
STAND	
20 T JACK STANDS WITH SCREW HIGH ELEVATION	156
DISPENSER/HAND TOWEL ROLL STAND FOR DRAWERS	101
JACK STANDS WITH SCREW 20T (x2)	156
STAPLE	
100 U-STAPLES	374
TOOL FOR REMOVING DOOR STAPLES	349
STAPLER	
HOT STAPLER	374
STARTING	
DIESEL STARTING BLEEDING PNEUMATIC KIT	191
STEERING	
BENZ ACTROS PITMAN ARM PULLER Ø42mm	267
STEERING GEARBOX	
STEERING GEARBOX PULLER	269
STETHOSCOPE	
ELECTRONIC STETHOSCOPE LEAK DETECTOR	247-362
MECHANICAL STETHOSCOPE	225
STONE	
3 STONE SET	228
STOOL	
TOOL-STORAGE STOOL	42
STOP RUST	
NO RUST SPRAY 400ml	331-334-47
STORAGE	
2 SPILL STORAGE SET WITH DRUM 250l	176
3 DRAWER/1 DOOR ROLLER CABINET	99
4 DRAWERS + 1 DOOR ROLLER CABINET HGV	96
4 DRAWERS + 1 DOOR ROLLER CABINET HGV 197 TOOLS	106
7 DRAWERS ROLLER CABINET	98
7 DRAWERS ROLLER CABINET XL 228 TOOLS	105
7 DRAWERS XL ROLLER CABINET	97
BODYWORK 3 TRAY STORAGE TROLLEY	323-40
FOAM STORAGE TRAY	101
PERFORATED PANEL TOOL RACK 500x900x30mm	39
STORAGE TRAY	
4PCS MAGNETIC TOOL TRAY SET	100
STRAIGHT BLADE	
10 PCS STRAIGHT BLADE SET 16mm	355
10 PCS STRAIGHT BLADE SET 20mm	355
STRAIGHTENING	
10T COLLISION REPAIR SET	342
12 PCS PULLING END SET	346
4T COLLISION REPAIR SET	342
50 PULLING RINGS SET	327
50 PULLING STARS SET (5 POINTED)	327
50 PULLING TRIANGLES SET	327
CENTRAL UNIT SPOT WELD AND DENT PULLER	327
CHARGER FOR SPOTER PULLING RINGS	327
LEVER PULLING BY POINT + 2 M5 ROUND ELECTRODES (SA0447)	327
M5 ROUNDED ELECTRODE	327
PULLING TWISTED 90° RINGS SET	327
RINGS/TRIANGLES/STARS HOLDER ELECTRODE	327
SLIDE STRAIGHTENING HAMMER FOR SPOT REPAIRS	327
SPOT WELD AND DENT PULLER	327
STRAP	
HGV STRAP WRENCH 1/2"	191
PISTON RING COMPRESSOR Ø53-125mm H.75mm	229
PISTON RING COMPRESSOR Ø65-135mm H.100mm	229
PISTON RING COMPRESSOR Ø90-175mm H.165mm	229
STRAP WRENCH DEHYDRATING CARTRIDGE	191
STRAP WRENCH	
HGV STRAP WRENCH 1/2"	191
METAL STRAP WRENCH FOR DESICCANT CARTRIDGE	191
STRAP WRENCH DEHYDRATING CARTRIDGE	191
STRIKING WRENCH	
3/4" STRIKING WRENCH L.219mm	261

STRIP	
STRAIGHT EDGE FOR CHECKING CYLINDER HEAD FLATNESS 400mm	230
STRAIGHT EDGE FOR CHECKING CYLINDER HEAD FLATNESS 600mm	230
STUD	
4 PCS WHEEL BOLT SYSTEM (MALE/FEMALE)	284
7 PCS STUD CLEANING KIT	285
WHEEL STUD THREAD RESTORER HGV	285
SUBSTITUTE	
GEARBOX OIL COOLER SUBSTITUTE DAF 95	210-234
SUCTION	
PUMP SUCTION CUP HGV Ø254mm CAPACITY 140kg	364
SUCTION CUP	
6 BODYWORK SUCTION CUP SET Ø85mm	364
DOUBLE SUCTION CUP	344
HANDLE-PUMP SUCTION CUP Ø165mm	364
MINI SUCTION CUP Ø50mm	365
PAIR OF SUCTION CUPS Ø115mm	365
PAIR OF SUCTION CUPS Ø140mm	365
SUCTION CUP SUPPORT RODS Ø120mm CAPACITY 20kg	344
SUPER GLUE	
SUPPLE SUPER GLUE 20g	360-50
SUPERCHARGER	
SCREW SUPERCHARGER 15CV EQUIPPED WITH DRYER+500I TANK 10bar	60
SUPPORT	
MAGNETIC PAINTWORK SUPPORT FOR REAR PARKING SENSOR L.500mm	371
PRIMARY SHAFT SUPPORT FOR ZF ECOSPLIT GEARBOX	235
SURFACE PLATE	
CAST IRON SURFACE PLATE FOR CHECKING HEAD FLATNESS	230-53
SWIVEL	
SWIVEL PRESS 100T+PUNCHES	270-281
SWIVELLING WHEEL	
PIVOTING WHEEL Ø120mm	42
SYNC	
MOVE/REMOVE HYDRAULIC KIT FOR VT VOLVO/RENAULT GEAR-BOX SYNCHRO	238
SYNCHRONIZATION	
3 SYNC CENTERING GUIDES FOR ZF AS TRONIC GEARBOX	237
SET OF 6 SYNCHRO MOUNTING CLIPS. REDUCING GROUP FOR ZF AS TRONIC GEARBOX	237
SYNCHRONIZATION CENTERING	
3 SYNC CENTERING GUIDES FOR ZF AS TRONIC GEARBOX	237
SYRINGE	
0.2I SYRINGE	171
1.5I SYRINGE	171
12 SYRINGE TRACER PACK 7,5ml FOR HYBRID VEHICLE	246
12 SYRINGE TRACER PACK 7,5ml FOR R1234 GAS	246
12 SYRINGE TRACER PACK 7,5ml FOR R134 GAS	246
TACHYMETER	
OPTICAL AND CONTACT TACHOMETER	52
TANK	
SCREW SUPERCHARGER 15CV EQUIPPED WITH DRYER+500I TANK 10bar	60
TAP	
37 PCS DRILL-TAPS-DIES SET	45
52 PCS TAP & DIE SET	45
75 PCS TAP & DIE SET	45
TAP HOLDERS AND RATCHET THREADERS BOX	45
TAP HOLDERS	
TAP HOLDERS M4-M12 / 3/16"-1/23	45
TELESCOPIC	
TELESCOPIC L-SHAPED WRENCH 1/2"	128
TEMPERATURE	
DIGITAL ELECTRONIC THERMOMETER	250
DIGITAL THERMOMETER	250
TEMPLATE	
GEARBOX AND DISTRIBUTION SHAFT MOUNTING GAUGE IVECO 10L	206
GEARBOX AND DISTRIBUTION SHAFT MOUNTING GAUGE IVECO 13L	206
TENSION TESTER	
VOLTAGE TESTER WITH SOUND	22
TESTER	
1/2" D. 110Nm IMPACT TORQUE EXTENSION	115
1/2" D. 120Nm IMPACT TORQUE EXTENSION	115
12V BATTERY TESTER	241
135Nm IMPACT TORQUE EXTENSION	115
AIRBAG LINE TEST	347
BRAKE & ABS PRESSURE GAUGE SET	252
BRAKE FLUID TESTER PROBE	252
MULTIFUNCTION TESTER 0-50V	20
MULTIMETER MEGOHMETRE AND INSULATION TESTER 1000V CAT. III	26
PNEUMATIC INSPECTION DEVICE TO TEST INSULATING GLOVES	27
POLARITY/CONTINUITY TESTER 3 TO 48V	22
UNIVERSAL CYLINDER LEAK DETECTOR TESTER	228
VOLTAGE SAFETY TESTER	26
THERMAL SCRAPER	
HOT AIR GUN 50-650°C	21-373
THERMOMETER	
DIGITAL ELECTRONIC THERMOMETER	250
DIGITAL THERMOMETER	250
INFRARED THERMOMETER -38°/520°	250
THICKNESS	
FEELER GAUGE SET	231-53
THREAD	
37 PCS DRILL-TAPS-DIES SET	45
52 PCS TAP & DIE SET	45
75 PCS TAP & DIE SET	45
METRICAL INNER/OUTER THREAD FILE 0.8-3.0	45
TAP HOLDERS AND RATCHET THREADERS BOX	45
THREAD LOCK	
MEDIUM-STRENGTH THREAD LOCK 10ml	228-50
STRONG THREAD LOCK 10ml	228-50
THREADED ROD	
THREADED ROD M10x1.5 L.350mm+NUT	280
THREADED ROD M12x1.5 L.350mm+NUT	280
THREADED ROD M14x1.5 L.350mm+NUT	280
THREADED ROD M16x1.5 L.350mm+NUT	280
THREADED WALL LIGHT	
THREADED ALUMINUM WALL LIGHT IN-OUT-F1/2G	64
THREADED ALUMINUM WALL LIGHT IN-OUT-F3/4G	64
TIE-ROD	
DOUBLE DRIVE TIE ROD MASTER WRENCH	268
TIE-ROD ASSEMBLER/REMOVER Ø30-Ø45mm WITH INTERCHANGEABLE HEADS 4PCS	268
TIMING	
ADJUSTMENT KIT VAG 2.5 PD TDI	211
MASTER TIMING TOOL SET RENAULT/NISSAN/OPEL/VOLVO	205
TIMING TOOLS FIAT 2.3 JTD	207
TIMING TOOLS RENAULT/OPEL/NISSAN/SUZUKI DCI	205
TINTED PANES FILM REMOVAL	
FILM REMOVAL KIT FOR TINTED PANES	354

INDEX • THEMATIC

TIPS INTERCHANGEABLE			
2 INTERCHANGEABLE TIPS 32mm	145-349	AIR CONDITION R134 CONTROL SET BY TRACER	246
2 INTERCHANGEABLE TIPS 32mm POLYURETHANE	145-349	AIR CONDITION TRACER SPRAY CLEANER 400ml	249
TIRE			
AUTOMATIC TIRE CHANGER 10"-24" ONE-SPEED	304	HYBRID VEHICLES AIR CONDITION TRACER BOTTLE 250ml	247
LEVER L.530mm FOR SMALL TUBELESS TRUCK TIRES	307	UNIVERSAL AIR CONDITION TRACER BOTTLE 250ml	247
PRESS ASSIST DEVICE FOR LOW PROFILE OR RUN FLAT TIRES	306	TRAILER HUB	
ROLL PLATFORM FOR BEAD BREAKER	306	8-SIDED HUB SOCKET R.O.R TRAILERS 127mm	298
TIRE RELEASER	307	8-SIDED HUB SOCKET R.O.R TRAILERS 84mm	298
TIRE REMOVER L.650mm	307	HEX REVERSIBLE HUB SOCKET FRUEHAUF TRAILERS 123mm/110mm	298
TIRE REMOVER SHEATHED L.495mm	307	TRANSFER	
TRANSLUCENT TIRE MOUNTING CREAM 1kg	309	METAL TRANSFER PUMP	170
TRANSLUCENT TIRE MOUNTING CREAM 5kg	309	TRANSFER PUMP	
TIRE CHANGER			
AUTOMATIC TIRE CHANGER 10"-24" ONE-SPEED	304	TRANSFER PUMP FOR DRUMS 200L	170
HGV TIRE CHANGER 19"-26" M126	303	TRANSMISSION	
HGV TIRE CHANGER <26" 1 SPEED SYSTEM 7226	302	4-PIN MAN TRANSMISSION SOCKET Ø53.5mm	289
HGV TIRE CHANGER <56" 1 SPEED SYSTEM M156	301	4-PIN SCANIA TRANSMISSION SOCKET Ø63-64mm	295
HGV TIRE CHANGER <56" 2 SPEED SYSTEM 7256	300	TRAPEZOIDAL BLADE	
LEVER L.530mm FOR SMALL TUBELESS TRUCK TIRES	307	10 PCS TRAPEZOIDAL BLADE SET	355
TIRE REMOVER L.650mm	307	TRAY	
TIRE CREAM			
Ø30mm ELBOW BRUSH FOR MOUNTING CREAM	309	ABRASIVE DISC HOLDER TRAY Ø50mm	329-86
Ø32mm STRAIGHT BRUSH FOR TIRE MOUNTING CREAM	309	BODYWORK 3 TRAY STORAGE TROLLEY	323-40
TIRE EXTRACTOR CHUCK			
TIRE RELEASER	307	FOAM STORAGE TRAY	101
TIRE FITTING			
PRESS ASSIST DEVICE FOR LOW PROFILE OR RUN FLAT TIRES	306	METAL TRAY 662x340mm	97
TIRE MOUNTING CREAM			
PACK BRUSHES+TRANSLUCENT TIRE MOUNTING CREAM 1kg	309	METAL WORKSHOP WASTE FOR DRAWER	101
TIRE PASTE			
Ø30mm ELBOW BRUSH FOR MOUNTING CREAM	309	PNEUMATIC CARRIAGE TROLLEY	299
Ø32mm STRAIGHT BRUSH FOR TIRE MOUNTING CREAM	309	TRIANGULAR WIRE	
TITANE DRILLS			
19 PCS TITANE DRILL SET Ø1-Ø10mm	82	TRIANGULAR WIRE REEL 50m	359
TOOLBOX			
METAL TOOLBOX 101 PCS	102	TRIM	
METAL TOOLBOX 3 STOREY/6 COMPARTMENT	95	11 PCS NYLON TRIM REMOVAL SET	349
TORCH			
MINI TORCH WITH RETRACTABLE TUBING + GAS REFILL	21	TRIM CLIP PLIER	
PLASMA CUTTER TORCH	326	TRIM CLIP PLIER	349
TORQUE			
3/8" PAWL REPAIR KIT	127	TROLLEY	
TORQUE MULTIPLIER R1:58 4800Nm+6 SOCKETS + 2 ADAPTERS 1" HGV	126-287	BODYWORK 3 TRAY STORAGE TROLLEY	323-40
TORQUE WRENCH 1/2" 42-210Nm 450mm	128	FIXED WHEEL Ø120mm	42
TORQUE WRENCH 1/2"D. 42-210Nm 461mm	127	LIFT TROLLEY WITH SCISSORS 800kg (HGV DRUM HOLDERS)	261
TORQUE WRENCH 1/4" 4-20Nm 335mm	128	MULTIFUNCTIONAL FOLDING WORKSHOP TROLLEY 150kg	323-42
TORQUE WRENCH			
120Nm PRESET 1/2" D. TORQUE WRENCH	128	PIVOTING WHEEL Ø120mm	42
TORQUE WRENCH 1" D. 200-1000Nm 1200mm	127	PNEUMATIC CARRIAGE TROLLEY	299
TORQUE WRENCH 1/2" 42-210Nm 450mm	128	WHEEL DOLLY HGV/PUBLIC WORKS/AGRICULTURAL	299
TORQUE WRENCH 1/2"D. 42-210Nm 461mm	127	TUBE	
TORQUE WRENCH 3/4" 100-500Nm 840mm	127	3 BEARING MOUNTING TUBES FOR ZF16 ECOSPLIT GEARBOX	236
TORQUE WRENCH 3/8" D. 30-110Nm 361mm	127	TUBE CUTTER	
TORQUE WRENCH WITH INTERCHANGEABLE HEADS 3/8" D. 30-110Nm 331mm	127-275	MINI TUBE CUTTER Ø3-22mm	260
TRACER			
12 SYRINGE TRACER PACK 7,5ml FOR HYBRID VEHICLE	246	ULTRASOUND	
12 SYRINGE TRACER PACK 7,5ml FOR R1234 GAS	246	TUB OF ULTRASOUND CLEANING SOLUTION 2l	181-214-351
12 SYRINGE TRACER PACK 7,5ml FOR R134 GAS	246	ULTRASONIC CLEANER 3L 100W 40KHz	181-214-351
AIR CONDITION R1234 YF CONTROL SET BY TRACER	246	ULTRASONIC CLEANER 9L 200W 40KHz	181-214-351
		ULTRASOUND CLEANING TUB	
		TUB OF ULTRASOUND CLEANING SOLUTION 2l	181-214-351
		ULTRASOUND TANK	
		ULTRASONIC CLEANER 3L 100W 40KHz	181-214-351
		ULTRASONIC CLEANER 9L 200W 40KHz	181-214-351
		ULTRASOUND TUB	
		TUB OF ULTRASOUND CLEANING SOLUTION 2l	181-214-351
		UV	
		BATTERY OPERATED UV LAMP	358
		MINI RECHARGEABLE INSPECTION LAMP 3W COB+1SMD	16
		UV MINI RECHARGEABLE INSPECTION LAMP	16-246
		VACUUM	
		CENTRAL VACUUM CLEANER 2x1300W	335
		COOLING LINE FILLING DEVICE	202
		VACUUM DENT PULLER	

MANUAL VACUUM DENT PULLER	344	PIVOTING WHEEL Ø77x20mm	42
VALVE		TIRE LIFTING DOLLY HGV	299
2 VALVE LAPPING TOOL SET	229	WHEEL DOLLY HGV	299
2-IN-1 REVERSIBLE VALVE/VALVE CORE REMOVAL TOOL	308	WHEEL DOLLY HGV/PUBLIC WORKS/AGRICULTURAL	299
PNEUMATIC VALVE GRINDING TOOL	230	WHEEL BALANCER	
SPRING LIFTER VALVE SET	229	HGV WHEEL BALANCER W142	310
VALVE CUTTING PLIERS	308	MOBILE HGV WHEEL BALANCER W102	311
VALVE SPRING LIFTER	229	WHEEL DOLLY	
VALVE STEM SEAL DISMOUNTING PLIERS	229	WHEEL DOLLY HGV/PUBLIC WORKS/AGRICULTURAL	299
2-IN-1 REVERSIBLE VALVE/VALVE CORE REMOVAL TOOL	308	WHEEL RIM	
SILENT VALVE CORE REMOVER	308	HGV BEAD KEEPER FOR ALUMINUM WHEEL RIM	306
VALVE FOR PIPE Ø20 FEMALE THREADED F 1/2 "G	65	RIM STAND	324
VALVE FOR PIPE Ø20 MALE THREADED 1/2 "G	65	WHEEL STUD SOCKET	
VALVE FOR PIPE Ø25 FEMALE THREADED F 3/4 "G	65	4 IMPACT SOCKET 1/2" KIT FOR ALU RIMS	115
VALVE FOR PIPE Ø25 MALE THREADED 3/4 "G	65	WINDSCREEN	
UNIVERSAL VALVE LIFT HGV/INDUSTRIAL VEHICLES	229	ONE-MAN WINDSCREEN RATCHETED REMOVAL KIT	361
VALVE STEM SEAL DISMOUNTING PLIERS	229	ONE-MAN WINDSCREEN REMOVAL KIT	361
2-IN-1 REVERSIBLE VALVE/VALVE CORE REMOVAL TOOL	308	REPAIR RESIN 10ml	358
VALVE STEM SEAL DISMOUNTING PLIERS	229	WINDSCREEN INSTALLATION AND REMOVAL ARM	364
VALVE SPRING LIFTER		WINDSCREEN LINE INSERTER	359
SPRING LIFTER VALVE SET	229	WINDSCREEN GASKET ROLLER TOOL	
VALVE SPRING LIFTER	229	WINDSCREEN GASKET ROLLER TOOL	360
VARNISH		WINDSCREEN LINE	
VARNISH SPRAY 1K 400ml	370	2-HANDLE LINE CUTTER KIT	359
VEHICLE DOLLY		WINDSCREEN PREPARATION	
VEHICLE DOLLY CASTER SYSTEM 1360kg (PAIR)	322	100 WINDSCREEN PREPARATION TOOL SET	360
VIALS		WINDSCREEN WASHER NOZZLE CLEANING	
SET OF 8 VIALS + HOLDER + HOSES	215	WINDSCREEN WASHER NOZZLE CLEANING TOOL	358
VIBRATION		WINDSCREEN WIPER	
VIBRATION PNEUMATIC PULLER FOR EXTRACTION INJECTORS	220	WINDSCREEN WIPER REMOVER	358
VICE		WINDSCREEN WIPER EXTRACTOR	
150mm 2 RUBBER COATING MAGNETIC JAW SET	41	UNIVERSAL WINDSCREEN WIPER EXTRACTOR	358
200mm 2 RUBBER COATING MAGNETIC JAW SET	41	WINDSHIELD REPAIR	
PARALLEL JAW CLAMPS 150mm QUICK TUBE HOSE APPROACH	41	WINDSHIELD REPAIR CASE	357
PARALLEL JAW CLAMPS 205mm QUICK TUBE HOSE APPROACH	41	WIPES	
VOLTMETER		5 230g MICROFIBERS SET 380x380mm	50
DIGITAL VOLTMETER 6-12V	22-241	80 CLEANSING MULTI PURPOSE WIPES	182-354-50
VOLUMETRIC GUN		90 CLEANSING WORKSHOP WIPES	182-308-50
DIGITAL VOLUMETRIC GUN 1/2" OIL/ANTIFREEZE	173-73	WIRE GUIDE	
W142		WIRE GUIDE	359
HGV WHEEL BALANCER W142	310	WIRE THREADER	
WALL MOUNTING RENFORT		WINDSCREEN LINE INSERTER	359
WALL MOUNTING RENFORT Ø20mm	64	WIRE THREADER	359
WALL MOUNTING RENFORT Ø25mm	64	WORKBENCH	
WALLBOX REEL		1.5m METAL WORKBENCH WOODEN TRAY	39
TYPE 1 WALLBOX WIFI REEL FOR ELECTRIC VEHICLE POWER SUPPLY	67	2m METAL WORKBENCH WOODEN TRAY	39
TYPE 2 WALLBOX WIFI REEL FOR ELECTRIC VEHICLE POWER SUPPLY	67	WRENCH	
WASHING		1/4"-1/2" US-INCH (52 PCS) COMPOSITION BOX SET	116
AIR CONDITIONING WASHING KIT	250	DOUBLE DRIVE TIE ROD MASTER WRENCH	268
MOBILE PARTS WASHER	181	FUEL FILTER WRENCH Ø109mm PSA/RENAULT 3/8"	191
WASHING AIR CONDITIONING		OIL DISTRIBUTOR REMOVAL WRENCH VT VOLVO/RENAULT GEAR-BOX	238
LIQUID CANISTER WASHING AIR CONDITIONING 5L	250	REAR HUB BOLT REMOVAL WRENCH RENAULT/MASCOTT 3/4" D.	288
WASTE		REVERSIBLE EXTENDED WRENCH 27-32mm Ø25.4mm L.400mm	286
METAL WORKSHOP WASTE FOR DRAWER	101	REVERSIBLE EXTENDED WRENCH 32-33mm Ø25.4mm L.400mm	286
WATER PUMP PLIER		SET OF 6 BRAKE/CLUTCH BLEED WRENCHES	260
QUICK-ADJUSTING HGV WATER PUMP PLIER 300mm	133	TELESCOPIC L-SHAPED WRENCH 1/2"	128
WHEEL		TORQUE WRENCH 1/4" 4-20Nm 335mm	128
FIXED WHEEL Ø120mm	42	TS 7 KEY SET TS10-TS15-TS20-TS25-TS27-TS30-TS40	140
PAIR OF PIVOTING BRAKED WHEELS Ø100x30mm	322	VAG HEADLIGHT ADJUSTMENT TOOL	368
PAIR OF PIVOTING WHEELS Ø100x30mm	322		

CONVERSIONS



1 inch (in) = 1 pouce = 2,54cm
 1 foot (ft) = 1 pied = 30,48cm
 1 yard (yd) = 1 verge = 0,9144m
 1 mile (mi) = 1 mille = 1,6093km
 0,6214mile = 1 kilomètre
 1 nautical mile = 1 mille marin = 1,852km



1 ounce (oz) = 1 once = 28,3495g
 1 pound (lb) = 1 livre (UK) = 0,4536kg
 1 short ton (tn) = 1 tonne courte (US) = 0,9072t
 1 long ton (tn) = 1 tonne forte (UK) = 1,0160t
 1 hundredweight (US) (cwt) = 0,4536quintal
 1 hundredweight (UK) (cwt) = 0,5080quintal



1 square inch (sq.in) = 1 pouce carré = 6,4516cm²
 1 square foot (sq.ft) = 1 pied carré = 9,2903dm²
 1 square yard (sq.yd) = 1 verge carré = 0,8361m²
 4840 square yard (sq.yd) = 1 acre = 0,4047ha
 1 square mile (sq.mi) = 1 mille carré = 2,590km²



100kPa = 1 bar = 14,503psi
 1,01325bars = 1 atm = 101,325kPa



1 cubic inch (cu.in) = 1 pouce cube = 16,3872cm³
 1 cubic foot (cu.ft) = 1 pied cube = 28317cm³
 1 cubic yard (cu.yd) = 1 verge cube = 0,7646m³
 1 once (US) (fl.oz) = 0,0296l
 1 once (UK) (fl.oz) = 0,0284l

1 quart (US) (qt) = 0,9463l
 1 quart (UK) (qt) = 1,1365l
 1 gallon (US) (gal) = 3,7853l
 1 gallon (UK) (gal) = 4,5460l
 1 barrel of oil = 1 baril de petrol = 0,1590m³



1 C° = 5/9 (°F-32)
 Conversion Celsius to Fahrenheit : C° = 5/9 (°F-32)

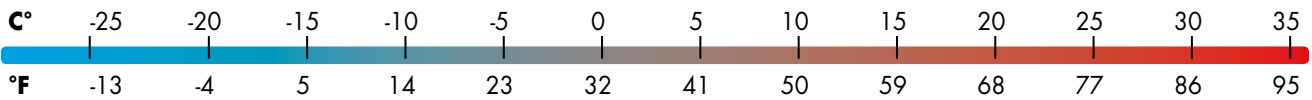

TIGHTENING TORQUE CONVERSION TABLE

The international unit is Nm (Newton x meter)

CONVERT Nm

1Nm = 0,102Mkg
 1Nm = 0,738Ft-lbs
 1Nm = 8,851In-lbs
 1Nm = 141,84In-Oz

CONVERT Ft-lbs

Foot-pound in Newton meter: 1Ft-lb = 1,35 Nm
 Foot-pound in mètre kilo: 1Ft-lb = 0,138 Mkg
 Foot-pound in Inch-pound: 1Ft-lb = 12 In-lbs

CONVERT In-lbs

1 In-lbs = 0,1128Nm
 1 In-lbs = 0,015Mkg
 1 In-lbs = 0,083Ft-lbs
 1 In-lbs = 15,873In-Oz

INGRESS PROTECTION RATING

1st digit: Solid particle protection



























- 0 No protection
- 1 Protected against solid particles superior to 50mm
- 2 Protected against solid particles superior to 12mm
- 3 Protected against solid particles superior to 2,5mm
- 4 Protected against solid particles superior to à 1mm
- 5 Dust protected
- 6 Dust tigh

2nd digit: Liquid ingress protection

- 0 No protection
- 1 Protected against dripping water
- 2 Protected against dripping water when tilted up to 15° from the vertical
- 3 Protected against spraying water when tilted up to 60° from the vertical
- 4 Protected against splashing water jets from any direction
- 5 Protected against water jets from any direction by a nozzle
- 6 Protected against powerful water jets from any direction
- 7 Protected against immersion
- 8 Protected against long-lasting immersion according to specified conditions

LEGEND

GENERAL

	Highlighted product		LCV/HGV		Product with electrical plug
	Warranty period		LV/LCV		Petrol
	No warranty		Power		Diesel
	Lifetime warranty		Decibel level		ADblue
	IP rating		Vibrations		Quicklift device (lifting range)
	Professional IP rating		Cable/hose length		Low profile
	Magnetic		Capacity		LED quantity
	Powered by battery		Maximum load		COB LED
	Impact wrench use recommended		Use oiler		Tension

RECESSES

	Flat		Double Hex female		Ribe		XZN
	Square		Torx		Ribe female		XZN female
	Phillips		Torx E		Ribe tamperproof		Superlock
	Hex		Torx tamperproof		TS		End ball Hex
	Hex female		Torx plus		TS plus		Pozidrive
	Hex tamperproof		Torx plus female		TS plus female		

PHILLIPS®: registered trademark of Phillips Screw Co.®
 TORX®: registered trademark of Camcar / Textron, Texas
 XZN®: registered trademark of Bauer-Schulte
 RIBE®: registered trademark of Richard Berger
 POZIDRIV®: registered trademark of European Industrial Services
 Collier Clic®: registered trademark of CAILLAU
 Circlips®: registered trademark of Nomel

Blackson®: registered trademark of Henkel Loctite
 Haldex®: registered trademark of Haldex Traction Systems
 AdBlue®: registered trademark of Verband der Automobilindustrie e.V. (VDA)
 VITON®: registered trademark of DuPont Performance Elastomers L.L.C.
 OETIKER®: registered trademark of Oetiker Schweiz AG

TERMS AND CONDITIONS OF SALE

General Terms and Conditions of Sale CLAS Equipements

Article 1 - PREAMBLE

The purpose of these terms and conditions of sale ("General Terms and Conditions of Sale" or "Conditions of Sale") is to set out the respective obligations and responsibilities of CLAS Equipements and the customer, acting within the framework of his professional activity (hereinafter the "Customer"), in their pre-contractual and contractual relations, relating to the sale of supplies by CLAS Equipements. The term "Supply(s)" refers to the services, systems, equipment and products sold by CLAS Equipements. These General Terms and Conditions of Sale constitute the sole basis for commercial negotiation.

They take precedence over the Client's general terms and conditions of purchase unless CLAS Equipements has given its express, prior and written agreement.

The fact that CLAS Equipements does not invoke at a given time the application of one or more of the provisions of the conditions of sale cannot be considered as a waiver of its right to avail itself of them at a later date, CLAS Equipements remaining always free to require their strict application.

In the event that one or more provisions of these General Terms and Conditions of Sale are found to be invalid by a competent court, the other clauses shall remain in force. In this case, CLAS Equipements will replace, if possible, this cancelled provision with a legally valid provision.

Article 2 - GENERAL

Proposals, offers, including those in its printed sales catalogue or published on its website or quotations issued by CLAS Equipements are valid only during the period defined by CLAS Equipements and are governed by these General Terms and Conditions of Sale supplemented or amended by the Special Conditions (see below).

The Client remains solely responsible for the use of the Supply, even if information, advice or diagrams have been provided to him by CLAS Equipements. As soon as the Supplies are resold by the Customer to an end user ("User"), the Customer warrants (i) to sell them only to professionals and (ii) to provide all the information, advice and schema that CLAS Equipements has been able to communicate to it and that (iii) this does not mean that its own advisory obligations are reduced. In addition, the Customer shall ensure that all obligations incumbent upon it hereunder shall, at a minimum, be transferred to the User so that the latter may benefit from the terms of the Contractual Warranty ("CLAS Warranty" described in these General Terms and Conditions of Sale). In this respect, it is notably the responsibility of the Client and the User, professionals by nature, to verify this information, advice or diagrams communicated by CLAS Equipements. In case of doubt, he must contact CLAS Equipements. The absence of a request made to CLAS Equipements on the form appearing at <https://www.clas.com/fr/nous-contacter>, under the heading Service to be contacted "S.A.V", implies a full and complete understanding of the conditions of use of the Supply. In the case of requests to <https://www.clas.com/fr/nous-contacter>, the User must provide a copy of the purchase invoice from the Customer to justify his purchase of the Supply. The absence of an invoice sent by the User that resulted in CLAS Equipements' response can in no way be considered as an implicit recognition to grant rights to this User.

Article 3 - CONCLUSION OF THE CONTRACT

All orders must be placed in writing by the Customer, including by email or in a dematerialized form from his customer account. It must accurately mention the exact references of the Supply ordered and the quantity or explicitly refer to an estimate or pro forma invoice issued by CLAS Equipements without any modification by the Client.

In any event, CLAS Equipements will make its best efforts to send a final acknowledgement of receipt of the order within one (1) working day, which will be the final document materializing the terms of the contract. This acknowledgement of receipt may take the form of a letter, e-mail or fax. In the absence of an order acknowledgement, CLAS Equipements' initial offer will be the contractual basis between the Parties and, unless expressly agreed in writing and signed by the parties, these General Terms and Conditions of Sale will apply to the Contract.

The sending or communication by the Client to CLAS Equipements of an order form with reference to its purchase conditions or on the back of which are printed the Client's purchase conditions shall not constitute acceptance by CLAS Equipements of these conditions.

Similarly, and without limitation, incomplete or erroneous information from the Client could lead to errors preventing CLAS Equipements in the execution of the order, such as delays that could not be attributed to CLAS Equipements.

Some sales terms and conditions imply the opening of a Customer account, in particular for orders from the online catalogue on the website www.clas.com. CLAS Equipements reserves the right not to act on an application to open a Client account or not to conclude a contract with the Client for a legitimate reason such as, for example, without limitation, not covered by credit insurance, inadequacy of the Client's commercial policy with the commercial ethics of CLAS Equipements, etc. without the Client being able to claim any

compensation of any kind whatsoever.

The terms and conditions hereof may be subject to specific terms and conditions ("Specific Terms and Conditions"). The latter will be offered by CLAS Equipements, in particular when connecting to its Customer account on the website www.clas.com. These special terms and conditions may derogate from these terms and conditions on points such as:

- Discount grids on catalogue prices
- Free shipping costs
- Specific payment terms and conditions
- ...

Orders by the Customer from the Customer's account will therefore include the Special Conditions and therefore orders for Supplies will be governed by these Sales Conditions supplemented by the Special Conditions.

Article 4 - SUPPLY SUBJECT TO THESE PRESENTATIONS

The Supply of CLAS Equipment is listed in pre-contractual documents (Catalogue, pro-forma invoice...) or contractual documents (Acknowledgement of receipt for acceptance...).

It is the Customer's responsibility to ensure, taking into account the characteristics of the Supply, that it corresponds to its needs, in particular in relation to the technical specifications of the Supply published by CLAS Equipements. The Customer must ensure that all the material and organisational conditions are met to enable the implementation and satisfactory and safe use of the Supply, such as qualified and trained personnel to use the Supply, an appropriate environment (premises, air conditioning, fluids, protection, etc.). CLAS Equipements having its registered office in France ensures that the Supply complies with the laws and regulations in force in France, which the Customer acknowledges and accepts.

When the Supply must comply with local standards at the place of use, in particular for safety, other than a French or European technical standard to which CLAS Equipements declares to comply, the Customer shall assume all the consequences resulting therefrom and CLAS Equipements shall not be held liable in particular for incidents occurring during their use.

The Client warrants CLAS Equipements for all consequences that may result from its own omissions or negligence.

Article 5 - MODIFICATIONS UNDER CONTRACT

Any modification of the contract requested by the Client, after the formation of the sales contract, must be expressly accepted by CLAS Equipements in writing with the express intention of derogating from it. Any request for modification of the contract may not be taken into consideration if it has been received after the Supplies have been dispatched.

Any request for modification of the order by the Client will be the subject of a new proposal from CLAS Equipements. In the event of refusal of modification by CLAS Equipements or disagreement of the Client on changes of any nature (technical or financial) related to its modification request, CLAS Equipements will deliver the Supply identified in the initial contract, under the conditions provided for therein.

No termination, suspension or termination of the contract by the Client may take place without the express, prior and written consent of CLAS Equipements, and under conditions that will compensate it for any harmful consequences.

Any tolerance or practice other than these General Terms and Conditions of Sale by the Parties shall not be deemed to constitute acceptance of any amendment to these General Terms and Conditions.

Article 6 - PRICE - TERMS OF PAYMENT

Unless otherwise expressly stated in the contract, the prices of the Supplies sold shall be those set out in the catalogue or price list in force on the day of the order and/or, where applicable, in the specific commercial proposal sent to the Customer, for the duration set out in one or other of these documents. These prices are, at these dates, firm and definitive. They are expressed in Euro, net and excluding VAT.

This price is indicated on a FCA Incoterm "Warehouse" basis according to the CCI 2020 Incoterms, a warehouse signifying the headquarters of CLAS Equipements with standard packaging. In any case, they do not include any loading and unloading, transport, customs and insurance costs that remain the responsibility of the Client. In the case of international sales, the Client undertakes to provide all documentation certifying that the goods have passed through customs in accordance with the regulations so that CLAS Equipements can fulfil its tax obligations. If the documents are not submitted as proof, the Client shall be liable for any taxes or penalties that CLAS Equipements may suffer as a result of the failure to submit said documents or as a result of late submission.

Any other specific request, in particular for sales outside metropolitan France, must be the subject of a specific written derogation offer from CLAS Equipements but in any case any customs charges or charges of any other nature, and insurance will remain the responsibility of the Client.

CLAS Equipements reserves the right to modify its prices at any time with thirty (30) calendar days' notice. Invoices are payable on the due date indicated on the invoice and/or commercial proposal.

Contracts concluded between CLAS Equipements and a company whose registered office is located in metropolitan

France and which makes the Supplies available in metropolitan France, shall be settled by bank transfer or cheque within thirty (30) days at the end of the month following the provision of the Supplies or the performance of the service by CLAS Equipements.

Contracts concluded between CLAS Equipements and a company whose registered office is located outside Metropolitan France and which makes the Supplies available outside metropolitan France, will be invoiced before the Supplies are made available, which invoice must be paid in full before CLAS Equipements informs the Customer of the availability of the said supply. These terms and conditions apply regardless of the incoterm used.

All other payment terms must be agreed in advance and in writing between CLAS Equipements and the Client.

Payment deadlines may not be delayed and the Client shall refrain from applying compensation and/or withholdings without the express prior written consent of CLAS Equipements.

CLAS Equipements reserves the right to demand payment for the Supply on the date of confirmation of the order (cash payment) by CLAS Equipements (i) if the Customer's financial situation justifies it or (ii) if the Customer has not paid all or part of the price of a previous order, or (iii) if no warranty as to the proper payment purposes has been given by the Customer.

In the event that the Client refuses these payment terms and conditions without any sufficient warranty being offered by the latter, CLAS Equipements may, as of right, not accept an order. Indeed, no agreement of intent will have been reached between the parties. Thus, no supply will be delivered without the Customer being able to claim any compensation of any kind whatsoever.

CLAS Equipements publishes its catalogue once a year and therefore the supplies could meanwhile undergo variations (i) in exchange rates as well as (ii) customs and transit costs, borne by CLAS Equipements. CLAS Equipements therefore reserves the right to pass it on to the sale price of the Supplies. Before any order confirmation, the Customer will be informed.

Similarly, in the event of a change in circumstances unforeseeable at the time the contract is concluded, if subsequent variations make the performance excessively onerous for CLAS Equipements at a level such that it would not have accepted to assume the risk at that point, CLAS Equipements may ask the Client to renegotiate the contract.

In the event of refusal or failure to renegotiate, the parties may agree to terminate the contract, on the date and under the conditions they determine, or request by mutual agreement that a judge adapt it. If no agreement is reached within a reasonable period of time, the judge may, at the request of a party, revise or terminate the contract on the date and under the conditions set by the judge.

The Parties expressly agree that failure to pay any payment term on its due date will result, without prior formal notice and ipso jure, in (i) the immediate payment of any other invoice, whether due or not, even if it has given rise to the creation of a draft, and (ii), at CLAS Equipements' free discretion, either the suspension of deliveries or the early payment of any order in progress. CLAS Equipements reserves the right, in the event of default of payment by the Client and after a formal notice has remained unsuccessful for thirty (30) days, to cancel orders not yet executed.

Any amount not paid on its due date shall also give rise to the payment by a Client whose registered office is located in France of a flat-rate indemnity for recovery costs in the amount of forty (40) euros and late payment penalties equal to the rate applied by the European Central Bank (ECB) plus ten (10) percentage points.

As soon as the Customer's registered office is located outside France, any amount not paid on its due date shall give rise to the payment by the Customer of a lump sum indemnity for recovery costs of one hundred (100) euros, excluding the penalties set out above.

The ECB's reference rate is that applicable on 1 January for the first half of a calendar year and on 1 July for the second half of a calendar year.

These penalties are automatically payable and will automatically be debited to the Client's account.

Article 7 - DELIVERY - TRANSFER OF RISKS

The delivery of the Supply shall take place in accordance with the terms and conditions set out in the proposal of CLAS Equipements and in accordance with Article 6 hereof. Thus, as soon as the Delivery is carried out in accordance with the terms and conditions of Article 6 FCA "Warehouse", the Customer acknowledges that it is up to the carrier to ensure the transport of the Supplies or, failing this, to take out additional transport insurance. The Customer therefore has no recourse against CLAS Equipements in the event of failure to deliver the Supply and/or damage to the Supply during transport.

If the Customer does not collect the Supply within one (1) month of sending a notice of availability of the Supply, storage and custody fees may be charged to the Customer.

If the Parties have expressly derogated from the terms of Article 6 and CLAS Equipements agrees to take charge of the delivery, the delivery terms are given as an indication and without warranty, regardless of the incoterm chosen. Exceeding these deadlines may not give rise to any deduction or compensation against CLAS Equipements. In the event of

a delay of more than 4 weeks in metropolitan France, and 8 weeks outside metropolitan France, the Customer may request the cancellation (resolution) of the order. Any deposits already paid will then be returned to him by CLAS Equipements. It is understood that deliveries outside metropolitan France may be made in instalments. Therefore, in this case, the Customer's acceptance of these terms and conditions implies that he will not be able to request the resolution of the Order since he will have accepted other terms and conditions with all the consequences that this could generate against him.

The time limits indicated are also automatically suspended by any event beyond its control, in particular in the event of force majeure, as defined in Article 8 of these conditions, which has the effect of delaying delivery. CLAS Equipements cannot be held liable in the event of delay or suspension of the delivery of the Supply.

As soon as the Customer takes possession of the Supplies, the risks of loss and deterioration are transferred to him, the Supplies travelling at the Customer's risk.

In any event, delivery within the deadline may only take place if the Client has fulfilled all its obligations towards CLAS Equipements.

Article 8 - FORCE MAJEURE

Upon the occurrence of a case of force majeure (unforeseeable, irresistible and external event), CLAS Equipements reserves the right to suspend, in whole or in part, the execution of orders, until the said case of force majeure is terminated.

Is considered as a case of force majeure within the meaning of these General Terms and Conditions of Sale (i) any event as defined by law and/or case law and (ii) one of the following events: total or partial strikes hindering the proper functioning of CLAS Equipements or that of one of its suppliers, subcontractors or carriers as well as the interruption of transport, the supply of energy, raw materials or spare parts.

Article 9 - RESERVE OF PROPERTY

The transfer of ownership of the CLAS Equipment Supply to the Customer is subject to full payment of the price in principal, costs and interest and to the Customer fulfilling all its obligations. Failure by the Client to submit compliant customs documents to CLAS Equipements may generate additional costs borne by this latter; thus, failure to submit said compliant documents constitutes only partial fulfilment of the Client's obligations, which suspends the transfer of ownership. Customs duties or tax consequences incurred in connection with the

The Customer shall refrain from (i) any transformation, incorporation or assembly of the Supply prior to its full payment or the fulfilment of all its obligations, and (ii) selling or pledging the Supply until ownership has been transferred to it.

The Customer is required to immediately inform CLAS Equipements of the seizure, requisition or confiscation in favour of a third party of the Supply, and to inform the third party creditor of the existence of this retention of title clause in favour of CLAS Equipements.

In the event of non-payment of the full principal price, costs and interest on the due date, CLAS Equipements may (i) demand at any time the return of the Supply sold, at the expense and risk of the Customer and (ii) automatically terminate the sale, upon simple written notification sent by any means, and without further formality or notice, without prejudice to any damages that may be claimed by CLAS Equipements. In this case, the Customer already authorizes CLAS Equipements and its carrier to enter the premises where the Supply is located during business hours to collect it. In this context, the Customer undertakes that all Supplies acquired from CLAS Equipements shall be easily identifiable on its premises.

These provisions do not prevent the transfer of the risks of loss and deterioration of the Supply under the conditions of Article 7 of these General Terms and Conditions of Sale.

Subject to the legal provisions in force, in the event of the opening of safeguard, recovery or judicial liquidation proceedings, current orders will be automatically cancelled, and CLAS Equipements reserves the right to claim the Supply in stock with the Customer.

In the event of return of the Supply under this article, the sums paid and constituting a partial payment of the Supply shall be retained by CLAS Equipements as compensation.

Article 10 - CONTRACTUAL WARRANTY

This contractual warranty ("CLAS Warranty") applies only to the Supply sold by CLAS Equipements to the Customer, who may transfer it to the User provided that the Customer complies or requests the User to comply with the following conditions.

The CLAS Warranty applies to the User only if the latter:

- or a professional in the automotive aftermarket sector.

It is expressly agreed that any sale made by the Client to non-professionals is made at the Client's own risk and responsibility. It is understood that the contractual warranty will not apply unless expressly decided by CLAS on a case-by-case basis, without any assumption of responsibility being considered as an amendment of the present contract."

- is able to demonstrate that the Supplies for which it requests the application of the Warranty have been invoiced by a CLAS Equipment Customer

These User-specific conditions are cumulative with the other terms of the CLAS Warranty below.

Each CLAS Equipment Supply has a pictogram indicating the contractual or non-contractual Warranty period of the Supply ("NO", 1, 2, 3, 4, 5 years, etc.). This information is available on the website www.clas.com as well as in the CLAS Equipment catalogue.

The warranty period is limited to the time indicated by the

CLAS Warranty pictogram from the date of delivery to the User by the Customer. Supplies known as consumables identified by the "NO" pictogram are excluded from any warranty.

10.1 - Non-conformities of the Supplies giving rise to contractual warranty

CLAS Equipements warrants the delivered Supply against non-conformities resulting from a defect in the Supply within the limits of the technical and contractual specifications of the Supply and within the limits of the provisions below.

The CLAS Warranty commitment applies only to the Supply, the subject of the contract, and with the exception of the Supplies that CLAS Equipements may deliver to you, but not to invoice the Customer. As soon as the said Supply has been sold by the User to a third party, CLAS Equipements will no longer provide any CLAS Warranty for the Supply. CLAS Equipements will decide alone on the terms of application of the said CLAS Warranty, namely the repair or replacement of the Supply. Repair or replacement will not extend the duration of the CLAS Warranty. The said CLAS Warranty takes effect on the date of taking possession either by the Client or by the User, depending on who requests it.

The CLAS Warranty will not apply in the event of:

- anomalies resulting from products or parts used by the Client/User with the Supply
- due to the intervention of a third party on the Supply sold by CLAS Equipements,
- defects due to fortuitous events or force majeure as well as for replacements or repairs resulting from accidents, abrasion, corrosion, normal wear and tear of the Supplies, deterioration resulting from negligence, lack of supervision or maintenance and defective use of the Supply,
- use under abnormal conditions or for operations and/or with unplanned elements, lack of qualification or experience of personnel,
- poor storage conditions of the delivered Supply,
- defective or non-compliant installation (incorrect connection, defective power supply) of Supplies.

10.2 - Customer's obligations

The implementation of the CLAS Warranty implies the provision by the Client/User of all the essential elements allowing CLAS Equipements to assess the nature and cause of the non-compliance subject to this Warranty.

The Client must provide documented written proof of the reality of the situation.

The absence of proof provided within 3 calendar months of the initial request for activation of the CLAS Warranty will result in the termination of this Warranty.

In addition, CLAS Equipements reserves the right to refuse the implementation of the CLAS Warranty in the event of non-payment by the Customer of all or part of an order. It will be responsible for the Users' requests in this respect and CLAS Equipements will be entitled to ask the Client for compensation if the Users' requests cause it damage.

The implementation of this contractual warranty implies that any return must be the subject of an express, prior and written agreement of CLAS Equipements and is at the Client's sole expense.

Any costs incurred by CLAS Equipements to confirm the assumption of responsibility under the warranty, which would ultimately prove to be outside the warranty, will be borne by the Client/User.

The Customer is required to carry out, upon receipt of the Supply, a check of the good condition and quantity of the delivered Supply. In this context, the Customer must inform CLAS Equipements, within forty-eight (48) hours of receipt of the Supply by the Customer, of any detailed reservations. After this mandatory period, no complaint of any nature whatsoever relating to apparent non-conformities will be accepted by CLAS Equipements. It is the Client's responsibility to manage Users' requests on this basis at least on the same terms and conditions and to set them up with the User.

10.3 Damages - Interest

The Contractual Warranty of CLAS Equipements is strictly limited to the obligations defined above and it is expressly agreed that CLAS Equipements shall not be liable for any other compensation for any reason and for any reason whatsoever such as damages or compensation of any kind whatsoever.

Article 11 - OTHER WARRANTIES

CLAS Equipements undertakes to warrants the Supplies, in addition to the CLAS Warranty in Article 10, only for any applicable legal warranties under the applicable law in accordance with the terms of Article 15.

Article 12 - LIABILITY

In no event shall CLAS Equipements be liable for indirect and/or intangible damage, whether consecutive or not, resulting from the performance of its obligations under the contract, such as, but not limited to, loss of income, loss of profit, business interruption, commercial unrest of any kind, the Client and its insurer waiving any recourse against CLAS Equipements and its insurers in this respect.

CLAS Equipements' overall and cumulative liability shall not exceed, and in any event, the total amount received by CLAS Equipements under the order or contract concerned.

Article 13 - INTELLECTUAL PROPERTY

Quotations, proposals, catalogues and, more generally, all documents delivered or sent by CLAS Equipements to the Client, as well as the related intellectual property rights, are and remain the sole property of CLAS Equipements or under licence from third parties, even if the Client has been asked to

contribute to the costs.

All these documents must not be reproduced under any circumstances without the prior written authorization of CLAS Equipements. This provision shall survive the expiry of the order or contract.

It is understood that the Client shall have no intellectual property rights relating to the Supply unless expressly agreed in writing by CLAS Equipements.

The Customer warrants that the User will exempt CLAS Equipements from any claim for counterfeiting or counterfeiting that may be brought against it because of joint use of the Supply with another product that constitutes an infringement of the intellectual property rights of third parties. In addition, the Client shall indemnify CLAS Equipements for all harmful consequences generated as a result of this situation.

Article 14 - SALE

The contract is concluded intuitu personae according to the person of the Client and cannot be assigned without the express, prior and written agreement of CLAS Equipements.

Article 15 - APPLICABLE LAW - ASSIGNMENT OF JURISDICTION

By express agreement between the parties, these General Terms and Conditions of Sale are governed:

(1) between CLAS Equipements and the Customer whose registered office is in France under French law and, in addition, under the Vienna Convention on the International Sale of Goods, or

(2) between CLAS Equipements and the Customer whose registered office is outside France, by Swiss Law, and, in addition, by the Vienna Convention on the International Sale of Goods

These conditions are written in French. In the event that they are translated into one or more languages, and in the event of any contradiction or discrepancy between the French version and the translation, the French version shall prevail over the translated version.

All disputes to which this contract may give rise, concerning its validity, interpretation, execution, termination, consequences and any other action shall be submitted:

(1) as soon as the Client has its registered office located in France, at the competent court of the registered office of CLAS Equipements, namely Chambéry (France).

(2) as soon as the Client has its registered office outside France, by arbitration in accordance with the Swiss Rules of International Arbitration of the Swiss Chambers' Arbitration Institution in force on the date on which the notice of arbitration is filed in accordance with these Rules.

a. The number of arbitrator(s) is set at one;

b. The seat of the arbitration shall be Geneva (Switzerland);

c. The arbitration will be conducted in French.

d. The Respondent shall submit to the Secretariat a response to the Notice of Arbitration, as well as any counterclaim or set-off, within fifteen (15) days from the date on which it received the Notice of Arbitration. The time limit for the appointment of an arbitrator shall be fifteen (15) days. If circumstances warrant, the Court may modify these time limits. The accelerated procedure will apply and the dispute will be decided only on the basis of documents.

e. The parties may also decide at any time to submit their dispute to mediation in accordance with the Swiss Rules of Commercial Mediation of the Swiss Chambers' Arbitration Institution.

Contacts

International sales departments :

+33 (0)4 79 72 69 18 > order@clas.com

FOR ANY INQUIRIES ABOUT OUR PRICES

Please contact your usual distributor

CLAS equipments does not bear liability for any omissions, typographical and errors or product modifications

Illustrations and photographs are not contractually binding.

CLAS Equipements SAS
SIREN 409 786 944 - RCS Chambéry



The origin of the paper comes from sustainably managed forests and controlled sources.





Tools and Men...

CLAS[®]

83 chemin de la Crouza
73800 CHIGNIN - France

Tel. : +33 (0)4 79 72 62 22

Fax : +33 (0)4 79 72 52 86

contact@clas.com

clas.com