

# CLAS<sup>®</sup>

BEYOND TOOLS, A TEAM



FROM APRIL 1 TO JULY 31, 2026

# SUMMER

SELECTION



# ANNIVERSARY OFFERS

*30 years - that's something to celebrate... and share!*

Throughout the year, **30** products at anniversary prices. Discover **10 exclusive** items in each selection.

## 1/4"-1/2" tool set (108pcs)

OS 3050BL

Contents for mechanical and industrial applications  
1/4" and 1/2".

~~99€ Excl. VAT\*~~

Anniversary Price

**64€ Excl. VAT**

TN

### Contents:

- black plastic case
- 3 hexagonal wrenches 1.5-2-2.5mm

### Contents 1/2":

- 1 1/2" ratchet 45 teeth
- 17 1/2" hexagon sockets: 10-11-12-13-14-15-16-17-18-19-20-21-22-24-27-30-32mm
- 5 long hexagon sockets 1/2": 14, 15, 17, 19, 21mm
- 2 extension sockets 1/2" L.125 and 250mm
- 1 1/2" gimbal
- 8 1/2" Torx sockets: E10-E11-E12-E14-E16-E18-E20-E24
- 2 1/2" spark plug sockets: 16-18-21mm
- 1 1/2" reducer

### Contents 1/4":

- 1 1/4" ratchet 45 teeth
- 13 hexagon sockets 1/4": 4-4.5-5-5.5-6-7-8-9-10-11-12-13-14mm
- 8 long 1/4" sockets: 6-7-8-9-10-11-12-13mm
- 2 extension sockets 1/4" L.125 and 250mm
- 1 1/4" universal joint
- 1 sliding bar 1/4" 115mm
- 1 sliding bar square
- 1 1/4" sliding handle
- 1/4" Nozzles:  
Flat: SL4-5-5-6-5  
Phillips: PH1-2 PZ1-2  
Hexagonal: 3-4-5-6 T8-10-15-20-25-27-30mm  
5 1/4" Torx sockets: E4-E5-E6-E7-E8

### 17 Nozzles 30mm:

- SL8-10-12 T40-45-50-55-60
- Phillips: PH3-4
- Pozidrive: PZ3, PZ4
- Hexagonal: 7-8-10-12-14mm



**2**  
WARRANTY

# ANNIVERSARY OFFERS

30 years — that's something to celebrate... and share!



30

## Ultrasonic cleaner 9l 200W 40khz

TN

OE 7201

~~529€ Excl. VAT\*~~  
Anniversary Price  
**399€ Excl. VAT**

### Specifications:

- heating temperature adjustable from 0 to 80°C
- timer 1 to 99 minutes
- power: 200W
- digital display
- tank drain valve
- bowl capacity: 9l
- bowl dimensions: 300x240x150mm
- external dimensions: 330x310x270mm



SA 7070 Tub of ultrasound cleaning solution concentrate 25% 2l 49€ Excl. VAT



## 1t low profile foldable crane

TN

OH 0335

~~449€ Excl. VAT\*~~  
Anniversary Price  
**349€ Excl. VAT**

### Specifications:

- double-acting pump
- 360° rotating pump
- deadman descent
- 3-position arm: 1000-800-700kg
- extra flat: 85mm
- nylon wheels
- weight: 71kg



## Angle grinder 125mm 20V brushless+2 batteries 4Ah+charger

TN

PW 3125

Anniversary Price  
**269€ Excl. VAT\***

### Specifications:

- max. power output (MWO): 800W
- 3 speeds
- disc diameter: 125mm
- idle speed: 6500/7500/8500 (rpm)
- spindle size: M14
- soft start
- blade stop: 3s
- cutting depth: 35mm
- voltage: 20V
- grinding vibration: ah=5.5m/s<sup>2</sup>, K=1.5m/s<sup>2</sup>
- sanding vibration: ah=1.9m/s<sup>2</sup>, K=1.5m/s<sup>2</sup>
- sound power: Lw=93.4dB(A), K=3dB(A)
- sound pressure: Lp=82.4dB(A), K=3dB(A)
- weight: 1.20Kg (without battery) / 1.85Kg (with battery)
- dimensions (LxWxH): 300x105x80mm (with battery)



### OFFERED

1/2" impact wrench  
680Nm 20V brushless  
without battery

PW 0681- 149€ Excl. VAT\*



TN



\*Recommended retail prices valid from January 1, 2026, to December 31, 2026. Photos are for illustrative purposes only -If no size is specified when ordering, CLAS reserves the right to deliver a random size. In the event of a stock shortage, CLAS reserves the right to deliver a gift of equivalent value.



# ANNIVERSARY OFFERS

30 years — that's something to celebrate... and share!

## Filling kit for nitrogen/hydrogen (N2-H2) leak detection 50bar

AC 1017

The tools contained in the case are used to "pressurize" refrigeration and air-conditioning systems in order to "simulate" the pressure at which the system will then have to operate.

Compatible with small and large bottles

By pressurizing the system with technical hydrogenated nitrogen (at an appropriate pressure, which differs depending on the refrigerant, as indicated by the sectors visible on the pressure gauge), the installer can be sure that, in the event of leaks due to poorly-made clamps, "cold" welds or manufacturing faults, these imperfections will be indicated by a loss of nitrogen detected by the pressure gauge provided. The system will then no longer encounter this type of problem.

### Contents:

- case
- SA4062: pressure regulator block with safety valve up to 50bar
- SA4060: isolation pressure gauge + 12cm flexible hose
- SA4063: reducer for 1kg cylinder
- SA1090: 1kg hydrogenated nitrogen cylinder (N2-H2)
- SA4061: 150cm piping
- SA4029: high-pressure fitting
- SA4052: high-pressure fitting for R1234yf gas



~~495€~~ Excl. VAT\* TN

Anniversary Price

**389€** Excl. VAT



## Cooling system tester (18pcs)

AC 1120BL

Secure your diagnostics with the AC 1120BL, the essential pressure test kit for instantly locating cooling system leaks. A complete, universal kit guaranteeing reliable intervention on 95% of the vehicle fleet.

### Contents:

- 1 test pump with relief valve
- 0 to 2.5bar pressure gauge
- 10 ABS screwed plugs (color-coded and numbered)
- 3 metal quarter-turn plugs
- 1 plug screwing wrench
- 1 thermometer 0 to 200°C
- 2 connectors R123/R124 and R123/R125



~~99€~~ Excl. VAT\* TN

Anniversary Price

**79€** Excl. VAT



# ANNIVERSARY OFFERS

30 years — that's something to celebrate... and share!



30

## Pneumatic brake bleeder set

HU 0050BL

Bleeds hydraulic brakes and clutches thanks to its pneumatic thrust operation.

### Specifications:

- pneumatic operation
- quick-connect hose for installation of various plugs
- handle
- maximum pressure 10 bar
- 5-liter capacity (DOT3/DOT4/DOT5/DOT6/LHM/Pentosin/LHS)

### Contents:

- HU 0051BL Steam trap only
- HU 0052BL Set of 11 plugs including universal E20
- HU 0053BL 1 recovery jerrycan



~~179€ Excl. VAT\*~~

TN

Anniversary Price

**139€ Excl. VAT**



## Brake caliper socket set (18pcs)

OM 0180

~~59€ Excl. VAT\*~~

TN

Anniversary Price

**39€ Excl. VAT**



Find the lineup on our website, [clas.com](http://clas.com)

### Contents:

- 3/8" hexagon socket bits:
  - H7 socket length 45mm
  - H7 socket length 65mm
  - H9 cavity length 23mm
  - H11 impression length 73mm
- 1/2" hexagon socket bits:
  - H10 impression length 12mm
- Hexagon socket L.25mm 3/8": H7, H8
- hexagon socket L.20mm 1/4": H9
- 1/2" pentagonal sockets: 10, 12.5, 14 and 19mm
- 7-point sockets: 14 and 22mm
- gear lock sockets (10 flats): 9, 11.5, 15 and 20mm



\*Recommended retail prices valid from January 1, 2026, to December 31, 2026. Photos are for illustrative purposes only -If no size is specified when ordering, CLAS reserves the right to deliver a random size. In the event of a stock shortage, CLAS reserves the right to deliver a gift of equivalent value.

CLAS

# ANNIVERSARY OFFERS

30 years — that's something to celebrate... and share!

30

## Pair of mechanical trolleys 2 x 590kg

OM 2034

Ideal for effortlessly moving vehicles that have broken down or are parked in tight spaces.

You can move parked, broken-down or other vehicles using one or two pairs of carts simultaneously. These carts will not only save you a considerable amount of time when handling vehicles, but will also enable you to optimize space in your garage or workshop - all without any effort.

### Specifications:

- lifting assisted by mechanical rack
- steel rollers L.280mm
- 4 wheels, 2 with brakes
- total capacity: 1180kg per pair
- working range: 340-710mm
- minimum and maximum wheel diameter: 450-810mm
- max capacity width: 11" (280mm)
- weight: 16kg

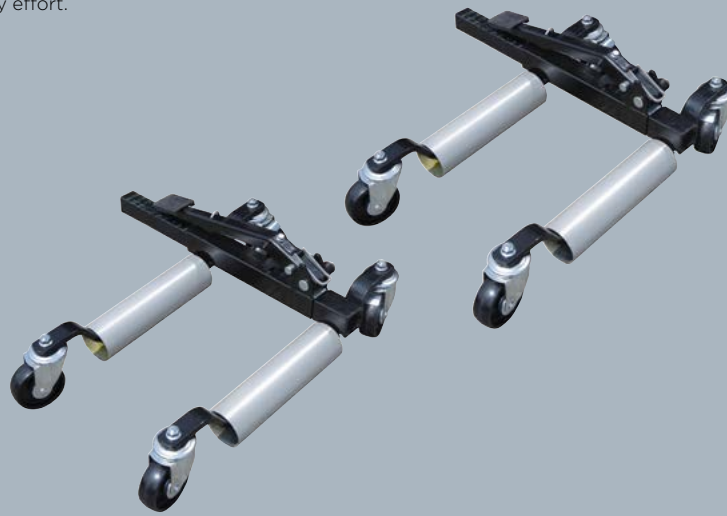

~~249€ Excl. VAT\*~~ **199€ Excl. VAT**

Anniversary Price

## Thinktool diagnostic tool T78 7"

AD000TKTT78

Product available for sale in France only.

The THINKTOOL T78 is an updated version with extended vehicle coverage. It supports DoIP, CAN FD and standard OBDII/EOBDII protocols after 1996. The T78 has the same diagnostic functions as the THINKTOOL Lite, including reading and deleting DTCs, reading the live data stream, maintenance reset, coding and more.

~~850€ Excl. VAT\*~~ **525€ Excl. VAT**

Anniversary Price



CAN protocol	CAN <sup>FD</sup> protocol	DOIP protocol	34 fonctions
Secure Gateway	HaynesPro	Diagnostic de niveau constructeurs	
7"	Android 10	CPU 2.0Ghz 4 cœurs	64 Go RAM
		6000 mAh	



**2 columns post lift high passage 3.90m  
400V 4T 4 arms 1.50m**

TE

PE 2238T

**4299€ Excl. VAT\***

Electro-hydraulic post lift.  
Direct push cylinder on cart.  
Hose and cable routing from the top for optimum working comfort, allowing free access to equipment under the vehicle (cylinders, oil recuperator, battery removal, etc.), facilitating workshop cleaning.  
Telescopic arms in symmetrical version with 4 x 1500 mm 3-stage arms.

Engine protection cover

Rideaux de protection des câbles

Skid-guided trolley: limits mechanical play

Punch-proof safety

Electric control

Reinforced electromagnetic safety latch on rack

240 V outlet

Door protection

Anti-crushing safety feature with stop and alarm

**Specifications:**

- lifting height: 950-1990mm
- drive power: 2.2kW
- drive voltage: (3 phases + Neutral) 400V/50Hz
- screw-adjustable buffers, stroke 70-140mm
- electrical release of safety catches
- emergency lowering system in case of power failure
- system synchronization: by cable
- intermediate stop 20cm above ground for user safety and anti-crushing audible signal
- motor protection cover
- door protection on columns
- 240V electrical socket on electrical box
- cylinder and cable protection strip included on each column
- supplied with 4 x 70mm risers and supports
- epoxy paint



\*Recommended retail prices valid from January 1, 2026, to December 31, 2026. Photos are for illustrative purposes only - If no size is specified when ordering, CLAS reserves the right to deliver a random size. In the event of a stock shortage, CLAS reserves the right to deliver a gift of equivalent value.

## Extra low profile scissor lift auxiliary lift 400V 5T on-ground

TE

PE 6250T

Particularly suitable for technical inspections, geometries and repairs  
 For installation on light and heavy-duty vehicles.  
 Work comfort: quick and easy vehicle mounting on the extra-low 140mm bridge.  
 Maximum safety: mechanical safety rack on main and auxiliary scissors to stabilize position.  
 Auxiliary lift capacity 4T with 2 galvanized extensions.  
 The secondary auxiliary cylinder is chrome-plated for enhanced durability.  
 Pneumatically locked swing plates.  
 Supplied with 2 swivel plates.  
 Equipped with rails for optional lifting crossbar. PE 7100

**15999€ Excl. VAT\***

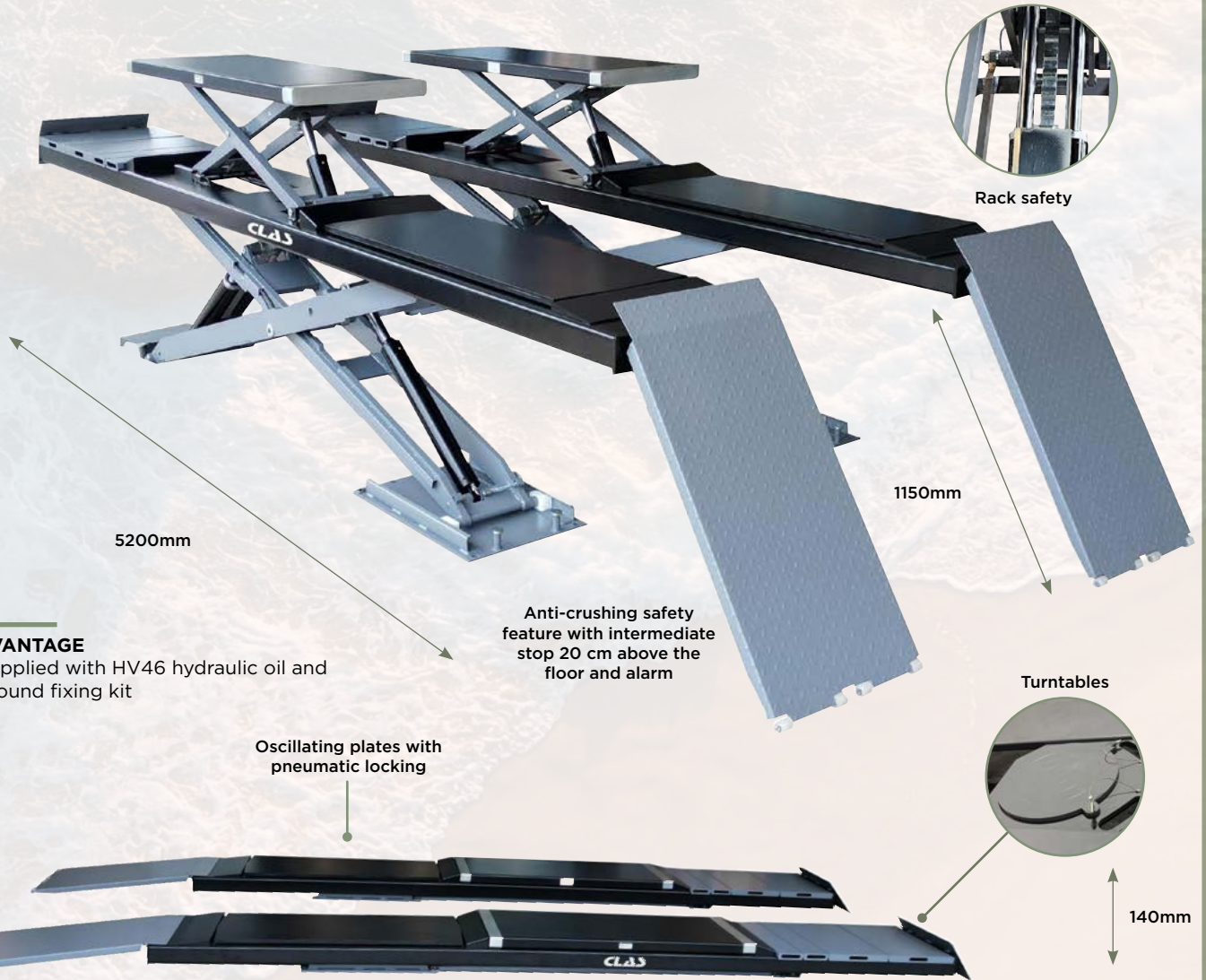

### AVANTAGE

Supplied with HV46 hydraulic oil and ground fixing kit

### Features :

- lifting height: 140-1850mm
- track width/length: 655/5200mm
- total length with access ramps: 6600mm
- system synchronization: photo cell
- control panel
- drive power: 3kw
- drive voltage: (3 phases + Neutral) 400V/50Hz
- air supply required 6-8 bar.
- oscillating plates pneumatic locking
- 2 extra-flat turntables included
- epoxy paint
- emergency lowering system in case of power failure
- intermediate stop 20 cm above ground for user safety and anti-crushing audible signal



Scan the QR code to see the full description!



**5T**



FROM APRIL 1 TO JULY 31, 2026

### Rectangular rubber pad 160x120x60mm

TN

EG 1136

**15€** Excl. VAT

Instead of 17€ Excl. VAT\*



Hardness 85° SHORE A  
Sold in multiples of 4 only



### Rectangular rubber pad 160x120x30mm

TN

EG 1137

**10€** Excl. VAT

Instead of 12€ Excl. VAT\*



Hardness 85° SHORE A  
Sold in multiples of 4 only



### Round rubber pad Ø124x26mm

TN

EG 1141

**11€** Excl. VAT

Instead of 13€ Excl. VAT\*



Rubber SBR 80° SHORE A  
Sold in multiples of 4 only



### Rectangular rubber pad 160x120x115mm

TN

EG 1143

**30€** Excl. VAT

Instead of 34€ Excl. VAT\*

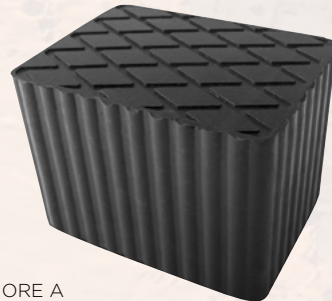

Hardness 85° SHORE A  
Sold in multiples of 4 only



### Tesla S.X.3.Y rubber pad

TN

EG 1171

Essential for safe, damage-free lifting of  
tesla model 3, Y, X and S vehicles.  
Sold in multiples of 4 only

NEW

**18€** Excl. VAT

Instead of 20€ Excl. VAT\*



Essential for safe, damage-free lifting of tesla model 3, Y, X  
and S vehicles.  
Sold in multiples of 4 only



## Tire changer with leverless 13-28" 2 speed system 400V

TE

DM 1900

4590€ Excl. VAT\*

### Specifications:

- horizontal arm moving on roller for easy translation
- jib equipped with a leverless pneumatic finger
- inflator with pressure gauge
- maximum tire diameter: 1100mm
- max. tire width: 3 to 14 inches
- arched platform with anti-pinch safety device
- outer rim diameter: 13 to 24 inches
- inner rim diameter: 15 to 28 inches
- 2 speeds without switch:  
rotation speed 1: 6.5 rpm  
rotation speed 2: 13rpm
- ergonomic, intuitive pedals
- telescopic, 4-position adjustable take-off scoop (2 open, 2 deep) with double-acting cylinder
- operating pressure: 8-10bar
- air cleaner and oil lubricator
- tubeless inflation safety valve: 3.5bar
- noise < 70dB
- power supply: 400V-50Hz
- power: 0.85-1.1kW
- bead breaker power: 2800kg
- dimensions: 1900x1580x2000mm

Please consult us for installation and commissioning.

Under warranty, installation and commissioning must be carried out by a professional.

Supplied with:

- SA8902: 5 protective pads for steel heads
- SA8903: 5 protective clips for steel heads
- SA8904: 1 protection shovel stripper
- SA8906: set of 4 aluminum rim protectors
- 1 tire changer with aluminum rim protector



Effortless



Scan the QR code to see the full description!

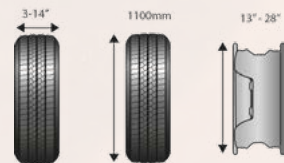

2 WARRANTY



## OFFERED

### Wheel lifter for tire changer

DM 0000 629€ Excl. VAT\*

TE

This assistant, compatible with the majority of tire changers on the market, will enable you to work quickly and effortlessly.

Thanks to its foot-operated pneumatic control, you can lift and rotate the wheel horizontally to position it on the tire changer table. As a result, the operation of placing the wheel on the table is completed quickly and with a minimum of physical effort, thus limiting the risk of MSD (musculoskeletal disorders).



2 WARRANTY



FROM APRIL 1 TO JULY 31, 2026

## Semi-automatic tire changer 10"-21" 1 speed 240V

DM 0600BL

### Specifications:

- maximum tire width: 3 to 12 inches
- outer rim diameter: 10 to 18 inches
- inside rim diameter: 12 to 21 inches
- rotation speed: 6.5 rpm
- ergonomic, intuitive crankset
- operating pressure: 8-10bar
- air cleaner and oil lubricator
- tubeless inflation safety valve: 3.5bar
- power: 0.85-1.1kW
- bead breaker power: 2500kg
- weight: 177kg



1399€ Excl. VAT

Instead of 1499€ Excl. VAT\*



## Manual motorized wheel balancer LED screen

EQ 0600BL

**B.LINE**  
BUDGET SOLUTION

### Specifications:

- power supply: 240V-50Hz
- motor power: 180W
- dimensions open housing: 880x980x1420mm
- LED display
- maximum wheel weight: 65kg
- minimum rim diameter: 10 inches
- max rim diameter: 24 inches
- rim width: from 1 to 20 inches
- manual measurement of 3 parameters: offset-diameter-width
- safety housing
- rotation speed: 200 rpm
- shaft: L.210mm-Ø40mmx4mm
- compartmentalized tray for cones and weights
- 4 storage supports
- noise level <70dB
- weight: 87kg



1290€ Excl. VAT

Instead of 1399€ Excl. VAT\*



Multiple programs

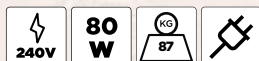

# SUMMER SELECTION

Pack hand lamp 2+1 off

**B.LINE**  
BUDGETSOLUTION

OE 0199BLX3

~~36€ Excl. VAT\*~~ TN

**24€ Excl. VAT**  
The bundle

8€ Excl. VAT per unit



**FREE**

**Specifications:**

- 4 lighting modes
- COB 10W LED lighting
- 5W XPE LED spotlight
- wattage: 200-400lm (front) + 50-100lm (spot)
- dimmable
- 6000 Kelvin
- runtime: 3 to 6h (front) / 4 to 8h (spot)
- charging time: 4h
- battery type: 3.7 V 1200 mAh Li-ion
- IP43 / IK07 protection
- 230° headlamp
- mounting: adjustable stretch headband
- weight: 100g
- 4 lighting modes
- COB 10W LED lighting
- 5W XPE LED spotlight
- wattage: 200-400lm (front) + 50-100lm (spot)
- dimmable
- 6000 Kelvin
- runtime: 3 to 6h (front) / 4 to 8h (spot)
- charging time: 4h
- battery type: 3.7 V 1200 mAh Li-ion
- IP43 / IK07 protection
- 230° headlamp
- mounting: adjustable stretch headband
- weight: 100g



2+1 post lift ramp offered

OE 0901X3

ABS and TPU body: highly resistant to impact and abrasion!

Ideal on lifts for ULTRA-powerful (3000Lumens!), targeted lighting thanks to 360° orientation



Double crochet

~~231€ Excl. VAT\*~~ TN

**154€ Excl. VAT**  
The bundle

51,33€ Excl. VAT per unit



**FREE**

**Specifications:**

- 30W COB LED lighting
- output: 500/3000 Lumens
- dimmable
- autonomy: 2 to 8h
- charging time: 3h
- charge indicator
- battery: Li-ion 7.4V - 2600mAh
- charging: USB-C
- IP44 / IK07 protection
- mounting: double hook + double 360° rotating magnet
- dimensions: 39x47x520mm
- weight: 480g
- distance between magnets 420mm (handles folded)



**Soldering iron 30W with stand**

TN

OE 0811

**19€ Excl. VAT**

Instead of 29€ Excl. VAT\*



The work support is equipped with two crocodile clips for holding printed plates.  
Weight: 560g



**Hot air gun 50-650°C**

TN

OE 6047

**85€ Excl. VAT**

Instead of 129€ Excl. VAT\*



**Specifications:**

- LCD display
- last temperature stored
- 5 airflow options from 250 to 500l/min
- CHC = constant heat control (protects against overheating and ensures continuous operation)
- handle for comfortable working
- temperature range: 50-650°C



**Parallel jaw Clamps 150mm quick tube hose approach**

TN

OM 4066

**249€ Excl. VAT\***

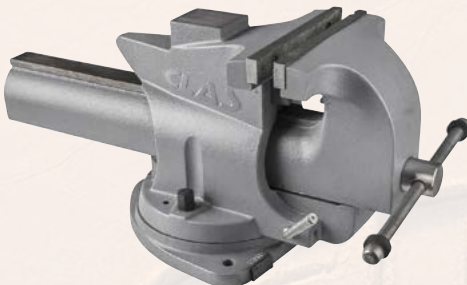

**Specifications:**

- jaw width: 150mm
- jaw height: 20mm
- jaw opening: 180mm
- interchangeable steel clamping jaws
- rotating base with 3 fixing points (155x190mm)
- weight: 24kg



**Parallel jaw Clamps 205mm quick tube hose approach**

TN

OM 4068

**349€ Excl. VAT\***

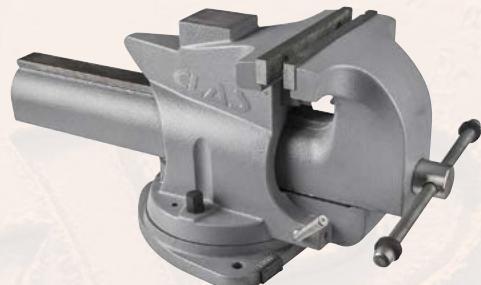

**Specifications:**

- jaw width: 205mm
- jaw height: 22mm
- interchangeable steel clamping jaws
- tube, anvil and horn jaws
- jaw opening: 260mm
- useful height inside vice: 95mm
- swivel base with 3 fixing points (180x208mm)
- power take-off for tube max diameter 75mm
- weight: 35kg



# SUMMER SELECTION

## Foot pedal trolley jack 3T

OH 6303

### Specifications:

- approach pedal
- overload protection
- double piston
- iron wheels
- min. height: 140mm
- max. height: 490mm
- dimensions: 626x330x167mm
- weight: 29.5kg

**165€** Excl. VAT

Instead of 179€ Excl. VAT\*



**3T**

**10**  
WARRANTY



## Extra flat trolley jack 3t 75mm

OH 7014

### Specifications:

- approach pedal
- controlled descent system
- overload protection
- pivoting rubber sole
- dual-pump quick-release system
- foam protection on handle
- PU front and rear wheels
- min. height 75mm
- max. height 510mm
- dimensions: 740x350x230mm
- weight: 32.5kg

**205€** Excl. VAT

Instead of 229€ Excl. VAT\*



**3T**

**10**  
WARRANTY



**1.5l Blue pressure sprayer**

TN

OC 1502



**6€ Excl. VAT**

Instead of 8,50€ Excl. VAT\*



**Manual priming pump with tappet**

TN

HU 0657BL



**8€ Excl. VAT**

Instead of 10€ Excl. VAT\*



**1/2" ratchet insert (23pcs)**

TN

OS 3000



**79€ Excl. VAT\***

OFFERED

**Ratchet insert 1/4" (59pcs)**

OS 3200 79€ Excl. VAT\*



**Telescopic pit jack 750 kg**

TN

OH 0280



**109€ Excl. VAT**

Instead of 129€ Excl. VAT\*

**Specifications:**

- foot-operated with precision adjustment
- wide base for greater stability
- quick adjustment
- wide handle for easy load support
- pedal push compensation: 2cm



**0,75T**



**Pit jack 1T**

TN

OH 0285



**539€ Excl. VAT**

Instead of 599€ Excl. VAT\*

**Specifications:**

- foot-operated
- 30mm diameter of free-standing end, 35mm cylinder rod diameter.
- wheelbase length 780mm and width 630mm.
- Fast pedal: 15mm rise with each pedal stroke.
- overload protection
- down control: deadman type
- supplied with removable head and pad
- 4 swivel wheels, 2 with brakes



**1T**



# SUMMER SELECTION

## 7-drawer roller cabinet+169 tools

EG 1410

TN



EG 1007

**690€** Excl. VAT

Instead of 749€ Excl. VAT\*



OS 3900

OS 4100

OS 3700

### Contents:

- EG1007: 7-drawer trolley
- OS1200: ph-slot diamond screwdriver insert (8pcs)
- OS3900: ratchet insert 1/2" 90 teeth (23pcs)
- OS2400: hexagonal T-wrench insert 3-10mm (7pcs)
- OS4100: combination wrench insert 6-24mm (17pcs)
- OS6000: special bits insert (43pcs)
- OS3700: 1/4" 90-tooth ratchet insert (55pcs)
- OS1306BL: pliers and hammer insert (16pcs)



OS 1306BL



OS 6000

OS 2400

OS 1200



## 7-drawer roller cabinet+388 tools

EG 1430

TN



EG 1007

**849€** Excl. VAT

Instead of 949€ Excl. VAT\*

### Contents:

- EG1007: 7-drawer trolley
- OS1200: diamond ph-slot screwdriver insert (8pcs)
- OS1210: diamond torx screwdriver insert T10-40 (7pcs)
- OS3900 : ratchet insert 1/2" 90 teeth (23pcs)
- OS2400: hexagonal t-wrench insert 3-10mm (7pcs)
- OS4100: combination wrench inserts 6-24mm (17pcs)
- OS6000: special bits insert (43pcs)
- OS3700: ratchet insert 1/4" 90 teeth (55pcs)
- OS5300: pliers insert (4pcs)
- OS5200: 178mm inside-outside circlip pliers (4pcs)
- OS6100: bit inserts (208pcs)
- OS4020: reversible ratchet insert 8-19mm (12pcs)

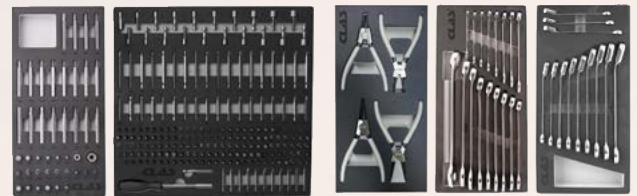

OS 6000

OS 6100

OS 5200

OS 4100

OS 4020



OS 5300

OS 3900

OS 3700

OS 1200

OS 2400

OS 1210



FROM APRIL 1 TO JULY 31, 2026

## 7-drawer roller cabinet+446 tools

EG 1450



### Contents:

- EG1007: 7-drawer trolley
- OS1200: diamond ph-slot screwdriver insert (8pcs)
- OS1210: diamond torx screwdriver insert T10-40 (7pcs)
- OS3900 : ratchet insert 1/2" 90 teeth (23pcs)
- OS2400: hexagonal t-wrench insert 3-10mm (7pcs)
- OS4100: combination wrench inserts 6-24mm (17pcs)
- OS6000: special bits insert (43pcs)
- OS3700: ratchet insert 1/4" 90 teeth (55pcs)
- OS5300: pliers insert (4pcs)
- OS5200: 178mm inside-outside circlip pliers (4pcs)
- OS6100: bit inserts (208pcs)
- OS3800: ratchet insert 3/8" teeth 90 teeth
- OS4020: reversible ratcheting combination wrench insert 8-19mm (12pcs)
- OS5399: 6-sided pipe wrench insert 8-19mm (12pcs)
- OS0070: pipe wrench inserts 8-19mm (6pcs)
- OS5499: 6-sided pipe wrench inserts 20-24mm (5pcs)
- OS4200: wrench inserts 27-32mm (4pcs)
- OS0850: hammer insert (10pcs)

EG 1007

**1299€** Excl. VAT

Instead of 1450€ Excl. VAT\*

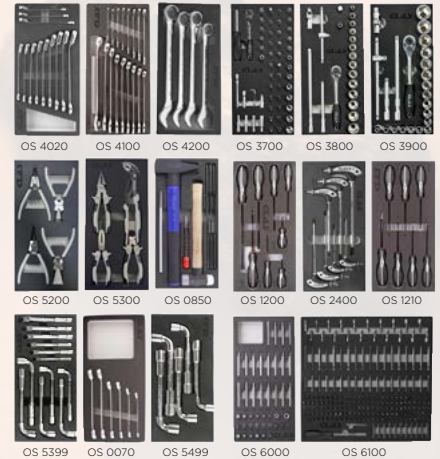

## 4-drawer roller cabinet+435 tools

EG 1480



### Contents:

- EG0076: maxi trolley 4 drawers + 1 box
- OS1200: diamond ph-slot screwdriver insert (8pcs)
- OS1210: diamond torx screwdriver insert T10-40 (7pcs)
- OS3900 : ratchet insert 1/2" 90 teeth (23pcs)
- OS2400: hexagonal t-wrench insert 3-10mm (7pcs)
- OS4100: combination wrench insert 6-24mm (17pcs)
- OS6000: special bits insert (43pcs)
- OS3700: ratchet insert 1/4" 90 teeth (55pcs)
- OS5300: pliers insert (4pcs)
- OS5200: 178mm inside-outside circlip pliers (4pcs)
- OS6100: bit inserts (208pcs)
- OS3800: ratchet insert 3/8" teeth 90 teeth
- OS4020: reversible ratcheting combination wrench insert 8-19mm (12pcs)
- OS5399: 6-sided pipe wrench insert 8-19mm (12pcs)
- OS5499: 6-sided pipe wrench insert 20-24mm (5pcs)
- OS0850: hammer insert (10pcs)

EG 0076

**1399€** Excl. VAT

Instead of 1599€ Excl. VAT\*





## Inverted thread impact socket set for damaged bolts

TN

OM 0630

**Contents:**

- Sockets length 38mm 1/2" drive
- SA0631: 17mm socket
- SA0632: 18.5mm socket
- SA0633: 20mm socket
- SA0634: socket 21.5mm
- SA0635: 23mm socket
- SA0652: socket 24.5mm
- SA0653: socket 26mm



**49€ Excl. VAT**  
Instead of 65€ Excl. VAT\*



## TPMS diagnostic tool VENU I-pro

TE

30000321

**Product available for sale in France only.**

VENU-i Pro is a professional TPMS diagnostic tool that can be used stand-alone via the i-venu mobile APP or in conjunction with a ThinkCar diagnostic tool.

It enables sensor activation, programming, diagnostics and other operations.

Compatible with 315MHz & 433MHz TPMS sensors



**160€ Excl. VAT\***

**OFFERED**

**4 tire deflator set for TPMS valves**

OM 7090 20€ Excl. VAT\*



TN



## Metal valve TPMS Venu 5 pro 315MHz & 433MHz

TE

ADTK5PRO

**20€ Excl. VAT**  
Instead of 23€ Excl. VAT\*

**Product available for sale in France only.**



## Rubber valve TPMS Venu 5 pro 315MHz & 433MHz

TE

ADTK6PRO

**20€ Excl. VAT**  
Instead of 23€ Excl. VAT\*

**Product available for sale in France only.**



## TPMS valve Tesla VENU 7bt

TE

30000341

**40€ Excl. VAT**  
Instead of 49€ Excl. VAT\*

**Product available for sale in France only.**



## Repair tool SAE male/female set

TN

OM 8050BL

**B.LINE**  
BUDGET SOLUTION

SAE: male taper  
DIN: female taper

### Contents:

- prints: Ø3/16" (4,75mm)-5/8"-1/2"-7/16"-3/8"-5/16"-1/4"
- tube cutter from Ø3 to Ø30mm



**34€ Excl. VAT**

Instead of 39€ Excl. VAT\*

**2**  
WARRANTY

## Din/SAE brake line repair kit

TN

OM 8047

This unit can be used to remake brake pipe collars. It will produce single or double SAE or DIN impressions on 4.75mm, 5mm or 6mm pipes. SAE: male taper  
DIN: female taper



**370€ Excl. VAT\***

**2**  
WARRANTY

# TO CONSIDER!

## Copper crown Ø4.75mm l.7.62m

TN

EG 0565

- Dimensions:
- Inside Ø 4.75mm
  - Outside Ø 5mm

**39€ Excl. VAT\***



**76 m**

**NO**  
WARRANTY

## Assorted brake line fittings set (135pcs)

TN

EG 0007

Complete 135-piece set designed for repairing and manufacturing brake hose fittings in the workshop.

**59€ Excl. VAT**

Instead of 95€ Excl. VAT\*



**NO**  
WARRANTY

# SUMMER SELECTION

## 90l gravity oil recuperator

TN

HU 0189

NEW

299€ Excl. VAT\*

### Specifications:

- 150cm bowl drain pipe
- Ø basin without extension: 370mm
- Ø basin with extension: 590mm
- basin equipped with a retaining grid
- supply for tank discharge: 0.5bar
- level indicator
- weight: 24kg
- min. h. : 1400mm
- max. height: 1700mm
- storage box

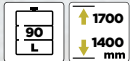

## 90l mixed oil recuperator with prechamber

TN

HU 0389N

429€ Excl. VAT\*

### Specifications:

- 150cm suction hose
- 150cm tank drain hose
- 5 flexible probes: Ø6/L. 700mm (2pcs); Ø8/L. 700mm (2pcs); Ø6/L. 900mm (1pc);
- suction drain: -2.5L.min
- power supply: 6 to 8bar
- Ø basin without extension: 370mm
- Ø basin with extension: 590mm
- basin equipped with strainer and retaining grid
- pre-chamber capacity: 10L
- supply for tank discharge: 0.5bar
- level indicator
- weight: 30kg
- min. height: 1400mm
- max. height: 1700mm
- storage box



## 25l waste oil drainer

TN

HU 0185BL

B.LINE  
BUDGET SOLUTION

249€ Excl. VAT\*

### Specifications:

- 150cm bowl drain pipe
- Ø basin without extension: 370mm
- Ø basin with extension: 590mm
- basin equipped with a retaining grid
- supply for tank discharge: 0.5bar
- level indicator
- weight: 24kg
- min. h. : 1400mm
- max. height: 1700mm
- storage box



FROM APRIL 1 TO JULY 31, 2026

## Euro 191 9" diagnostic tool

30001084

**Product available for sale in France only.**

9" bi-directional diagnostic tool at the best value for money!

**Specifications:**

- operating system: Android 10
- display: 9" screen
- CPU: 2.0Ghz / 4 cores
- storage: 64GB
- memory: 4GB
- battery: 4150mAh

THINKCAR has just released a new advanced diagnostic tool, the THINKTOOL 191, with an all-new user interface and a new, lighter and slimmer design, supporting the CAN-FD, DOIP protocols commonly used for vehicles.

Advanced diagnostic function

Full system scan, basic coding, bidirectional control, special function.

- AutoSearch: automatic reading of vehicle VIN to identify manufacturer, year and model, enabling rapid system diagnosis.
- Read / clear fault codes (DTC)
- Real-time data reading
- Actuator testing (bidirectional)
- ECU coding
- Generation and management of diagnostic reports
- History of recorded sessions
- Lightweight, modern design, easy to carry
- Bluetooth Diag Mini 2 connector
- Support for advanced protocols: CANFD, DoIP, OBDII/EOBD
- Over 140 pre-installed vehicle software packages



NEW

750€Excl. VAT

Instead of 800€Excl. VAT\*



2 WARRANTY

## Euro 391 10" diagnostic tool

30000074

**Product available for sale in France only.**

REMOTE VL/VUL range: 10" professional diagnostic tool

**Specifications:**

- operating system: Android 10 - TCOS System
- display: 10" screen
- CPU: 2.0Ghz / 4 cores
- storage: 128GB
- memory: 4GB
- battery: 12600mAh
- rear camera: 13M

THINKTOOL Euro 391 is a brand new diagnostic tool. It supports over 120 passenger cars, over 70 electric vehicles with the EV package (optional) and over 150 trucks with the HGV package (optional)

The new TCOS system offers an optimized user interface and easier operation.

10.1" IPS display with 1280\*800 resolution, high-performance 4-core MT8766 processor, 4GB+128GB memory, 13MP rear flash camera. Supports dual WiFi communication for faster diagnostics.



NEW

1900€Excl. VAT

Instead of 2100€Excl. VAT\*

Combined with VCI THINKLINK LITE, it supports CAN 2.0

Associé à la VCI THINKLINK LITE, il prend en charge le CAN 2.0, CAN FD, DOIP et les principaux protocoles de diagnostic tels que J2534, couvrant les véhicules de tourisme et à énergie nouvelle.

Diagnostic complet du système de niveau de l'équipement d'origine

Le nouvel Euro 391 prend en charge des fonctions de diagnostic avancées, telles que le balayage complet du système, le test d'actionnement, le codage et les fonctions de programmation en ligne.

Supporte les modules fonctionnels THINKCAR tels que le test de batterie, le vidéoscope, l'oscilloscope, le TPMS, le programmeur de clé.



2 WARRANTY



## Thinkscan hgv 5" diagnostic tool

TE

30001107

NEW

700€ Excl. VAT\*

Product available for sale in France only.

### Specifications:

- storage: 64GB
- ram: 2Gb
- 3150mAh/3.7V battery
- 5" display
- 1.2m diagnostic cable



Intended for technicians specializing in heavy-duty vehicles, it enables complete diagnosis of the main ECUs: ABS, SCR, braking systems, engine and transmission. Covering over 70 truck makes.

Its 5-inch touchscreen and fluid Android system make it easy to use, while online updates via Wi-Fi, free for 2 years, ensure that the tool is always up to date.

Compatible with a wide range of makes and models, thanks to support for J1939, J1708, CAN-FD and OBD-II protocols, it is an indispensable piece of equipment for HGV workshops.

In a nutshell:

- In-depth analysis of electronic modules: engine management, ABS, transmission, SCR emission control system and other on-board ECUs.
- Reads and eliminates fault codes on commercial vehicles, trucks and vans.
- Initiate DPF/FAP regeneration to restore exhaust system efficiency.
- Program and calibrate injectors after replacement or servicing.
- Reset AdBlue system (SCR) and electronic parking brake.
- Speed limiter readjustment, available according to vehicle configuration.
- Cylinder-by-cylinder deactivation test to check engine balance.
- Live visualization of parameters in the form of graphs or dynamic tables.
- Automatic vehicle identification via Auto VIN, for immediate time savings.
- Control of I/M systems, O2 sensors and EVAP circuits on 12 V commercial vehicles via OBD-II interface.

- 8 reset modules:

DPFS regeneration, oil change reset, injector coding, clutch pairing, brake reset, SCR reset, speed limit reset, cylinder test.



FROM APRIL 1 TO JULY 31, 2026

## Digital automatic air conditioning station R1234yf

AC 9344

Easy-to-use digital machine.

With printer and heating belt!

### Specifications:

- for R1234yF gas
- 7" color touchscreen
- hybrid/electric vehicle compatible thanks to "Auto-Clean" rinsing system
- 100l/min pump
- gas recovery 250g/min
- >95% recovery
- heated belt
- printer
- 2 bottles (used oil, new oil)
- 3m hose kit
- HP/BP quick couplers
- internal cylinder 7Kg / operational limit 1Kg
- gas scale accuracy +/- 5g
- oil scale accuracy +/- 1g
- factory-assembled and tested



Scan the QR code to see the full description!



NEW

R1234yf

2999€ Excl. VAT\*



2 WARRANTY

## Digital automatic air conditioning station R134a

AC 9544

Easy-to-use digital machine.

With printer and heating belt!

### Specifications:

- for R134a gas
- 7" color touchscreen
- hybrid/electric vehicle compatible thanks to "Auto-Clean" rinsing system
- 100l/min pump
- gas recovery 250g/min
- >95% recovery
- heated belt
- printer
- 2 bottles (used oil, new oil)
- 3m hose kit
- HP/BP quick couplers
- internal cylinder 7Kg / operational limit 1Kg
- gas scale accuracy +/- 5g
- oil scale accuracy +/- 1g
- factory-assembled and tested



Scan the QR code to see the full description!



NEW

R134a

2999€ Excl. VAT\*



2 WARRANTY

# SUMMER SELECTION

## Universal electronic leak detector R134a/1234yf/hydrogen

TN

AC 7495

This leak detector features a sensor designed to detect the smallest concentrations of hydrogenated nitrogen and other gases. Compatible with hydrogenated nitrogen (N2-H2), R134a, R1234YF, R404-A, R410-A, R407-C, R22, Freon...

When a concentration is detected, an audible alarm sounds and the display indicates the size of the leak (from 1 to 7). Specifications:

- 3-level adjustable sensitivity
- automatic calibration
- sensor type: semiconductor
- built-in fan
- power supply: 4 AA alkaline batteries
- operating time: 4-6h continuous
- low battery indicator
- warm-up time: 45s
- probe length: 40cm
- supplied in case with batteries



**375€ Excl. VAT**

Instead of 399€ Excl. VAT\*



## Polymerization control cylinder R1234YF

TN

AC 2034



AC 9344

Polymerization of R1234YF gas can cause serious damage to stations and vehicles! These days, it's essential to check the quality of the gas in your cylinders before carrying out any work.

**165€ Excl. VAT**

Instead of 179€ Excl. VAT\*



Check the quality of the gas in your cylinder and ensure there is no polymerization in just a few seconds.



## TO CONDISER!

Find the detection kit on page 4

### 1kg nitro-trace cylinder (N2-H2)

TN

SA 1090



**35€ Excl. VAT\***

1kg: Nitrogen 95% and hydrogen 5%.



### 2.2kg nitro-trace cylinder (n2-h2)

TN

SA 1092



**65€ Excl. VAT\***

Nitrogen 95% and hydrogen 5%.



FROM APRIL 1 TO JULY 31, 2026

### Air conditioning R134a control set by tracer

TN

AC 4052

**79€** Excl. VAT

Instead of 97€ Excl. VAT\*



### Air conditioning R1234yf control set by tracer

TN

AC 4053

**81€** Excl. VAT

Instead of 99€ Excl. VAT\*



### Rechargeable uv light

TN

OE 0699

#### Specifications:

- LED UV 3W
- wavelength 395nm
- operating time: 3h
- charging time: 4h
- charge indicator
- battery: Li-ion 3.7V - 2200mAh
- charging: USB-C + docking station
- IP66 / IK07 protection
- mounting: hook + double magnet (back + base)
- 180° articulated magnetic base
- dimensions: 56x35x190mm
- weight: 360g



**39€** Excl. VAT

Instead of 59€ Excl. VAT\*



### Air Purifiers / Air Fresheners

TN



		Selection Price x12	Catalog Price*
CO 6255	Anti-smoking smell spray 200ml	<b>8€</b> Excl. VAT	9€ Excl. VAT*
CO 1076	Cabin purifier 400ml mint	<b>8€</b> Excl. VAT	10€ Excl. VAT*
CO 1075	Cabin purifier 400ml musk	<b>8€</b> Excl. VAT	10€ Excl. VAT*
CO 1074	Cabin purifier 400ml lemon	<b>8€</b> Excl. VAT	10€ Excl. VAT*
CO 6216	Cabin purifier 400ml lavender	<b>8€</b> Excl. VAT	10€ Excl. VAT*
CO 6218	Cabin purifier 400ml pine	<b>8€</b> Excl. VAT	10€ Excl. VAT*
CO 6217	Cabin purifier 400ml foaming	<b>8€</b> Excl. VAT	10€ Excl. VAT*
CO 6220	Cabin purifier 400ml vanilla	<b>8€</b> Excl. VAT	10€ Excl. VAT*



\*Recommended retail prices valid from January 1, 2026, to December 31, 2026. Photos are for illustrative purposes only - If no size is specified when ordering, CLAS reserves the right to deliver a random size. In the event of a stock shortage, CLAS reserves the right to deliver a gift of equivalent value.

# SUMMER SELECTION

## Digital thermometer

TN

AC 4223

**45€ Excl. VAT**

Instead of 50€ Excl. VAT\*

### Specifications:

- digital display
- temperature range: -40° to 250°C
- stainless steel probe
- automatic shut-off
- power supply: LR44 battery (included)
- accuracy:
  - ±2% (between -40°C and 200°C)
  - ±3% (between 200°C and 250°C)



## Digital electronic thermometer

TN

AC 4224

**60€ Excl. VAT**

Instead of 75€ Excl. VAT\*

### Specifications:

- digital display
- temperature range: -50° to +300°C
- stainless steel probe
- pressure ±1°C
- 1.5V AAA battery
- cable length: 900mm
- probe length (chrome-plated part): 170mm
- cable + probe length (with handle): 1200mm



## Infrared thermometer -38°/520°

TN

OE 5036

- Reliable measurements thanks to its high-precision laser sight.
- The practical infrared thermometer enables non-contact measurement of surface temperatures from a safe distance.
- Specifications:
- measurement temperature: -38°C/520°C (-36.4°F/968°F)
  - measurement accuracy: ± 2°C
  - response time: 1s
  - resolution: 0.1°C/0.1°F
  - automatic brightness cut-out after 15s
  - automatic switch-off after 60s without intervention
  - power supply: 2 AAA 1.5V batteries



**69€ Excl. VAT**

Instead of 89€ Excl. VAT\*



## 2-way pressure control manometer set R134a

TN

AC 9153

Suitable for filling and inspecting air-conditioning systems, providing system pressure readings.



**R134a**



**190€ Excl. VAT**

Instead of 200€ Excl. VAT\*



### Air conditioning leak stop for R134a 30ml

TN

CO 4065

R134a



**23€ Excl. VAT**

Instead of 25€ Excl. VAT\*



### Air conditioning leak stop for R1234yf 30ml

TN

CO 4070

R1234yf



**25€ Excl. VAT**

Instead of 29€ Excl. VAT\*



### Gun and spray cleaning set for air con system 600ml

TN

AC 9156



OFFERED

Air con cleaning spray 600ml

CO 6258 20€ Excl. VAT\*



**82€ Excl. VAT**



### Air conditioning washing kit

TN

AC 1023

An economical way to remove contaminants and scale from air-conditioning system components.



**359€ Excl. VAT\***

OFFERED

Liquid canister washing air conditioning 5l

CO 1070 63€ Excl. VAT\*



### A/C flushing adapter kit

TN

AC 4061

AC 1023

Set of conical adapters for connecting washing equipment to A/C systems.

**Contents:**

- 2 clamping cones with 1/4 SAE connection
- 5 sets of plates
- 3 sets of cones
- 1 storage case



**112€ Excl. VAT**

Instead of 122€ Excl. VAT\*



# SUMMER SELECTION

## Detection kit / air conditioning impurities filtration system R134a

TN

AC 1018

R134a

**290€** Excl. VAT

Instead of 399€ Excl. VAT\*

This kit allows you to visually check the condition of the air-conditioning system.

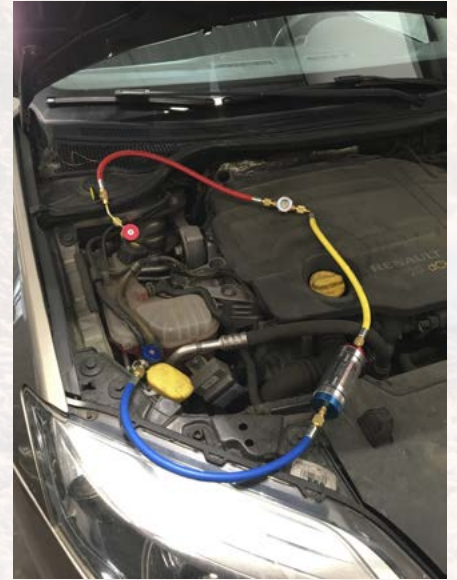

## Detection kit / air conditioning impurities filtration system R1234YF

TN

AC 1019

R1234yf

**429€** Excl. VAT\*

This kit allows you to visually check the condition of the air-conditioning system.



## Air Purifiers / Air Fresheners

TN

Find the complete range of air conditioning oils at [clas.com](http://clas.com).



### PAG 60

Not compatible with other oils

GRADE/ GAS	Universel	SANDEN Compressor	Order x 1	Order x12
Universel (R134a et R1234yf)	CO 4080 (250 mL)	YES	13€Excl. VAT*	10€Excl. VAT per unit
	CO 4081 (1L)	YES	35€Excl. VAT*	31€Excl. VAT per unit

### PAO

Fully synthetic (polyalphaolefin) Compatible with mineral oils

GRADE	Universel	SANDEN Compressor	Order x 1	Order x12
Universel (R134a et R1234yf)	CO 6137 (1L)	YES	30€Excl. VAT*	25€Excl. VAT per unit

### POE 80

Electric compressors (dielectric lubricant)

GRADE/ GAS	Universel	Compresseur SANDEN	Order x 1	Order x12
Universel (R134a et R1234yf)	CO 4099 (250 mL)	NO	27€Excl. VAT*	22€Excl. VAT per unit

### Range of oil tracers

	PAG oil	Order x 1	Order x12	Other types of oil	Order x 1	Order x12	Hybrid vehicle	Order x 1	Order x12
R134a	CO 6262 (350mL)	27€EXCL. VAT*	23€Excl. VAT per unit	CO 6265(250 mL)	28€EXCL. VAT*	24€Excl. VAT per unit			
				CO 6264 (1L)	68€EXCL. VAT*	59€Excl. VAT per unit			
R1234yf	CO 6161(5L)	153€EXCL. VAT*	123€Excl. VAT per unit	CO 6263(1L)	31€EXCL. VAT*	27€Excl. VAT per unit			
Universel				CO 4068(250 mL)	29€EXCL. VAT*	27€Excl. VAT per unit	CO 4069 (250 mL)	34€EXCL. VAT*	29€EXCL. VAT per unit
				CO 6266(1L)	90€EXCL. VAT*	78€Excl. VAT per unit			

	Other oil Order x12	Order x 1	Order x 10	Hybrid vehicle	Order x 1	Order x12
R134a	CO 4077	33€EXCL. VAT*	27€EXCL. VAT per unit	CO 4079	22€EXCL. VAT*	17€EXCL. VAT per unit
R1234yf	CO 4078	35€EXCL. VAT*	29€EXCL. VAT per unit			
Universel	CO 6253	33€EXCL. VAT*	29€EXCL. VAT per unit			

### Vacuum pump oil range

GRADE/ GAS	32	Order x 1	Order x12	46	Order x 1	Order x12
Universel (R134a et R1234yf)	CO 6138 (1L)	20€Excl. VAT*	17€Excl. VAT per unit	CO 6140 (500mL)	12€Excl. VAT*	10€Excl. VAT per unit
				CO 6139 (1L)	20€Excl. VAT*	17€Excl. VAT per unit

# SUMMER SELECTION



## Valve/connector/plug air conditioning maintenance set

TN

AC 4034

Assortment of fittings, plugs and valve cores for all basic maintenance of R134a air-conditioning systems.  
Retail components available.



NO WARRANTY

**99€ Excl. VAT**

Instead of 120€ Excl. VAT\*

## Air conditioning maintenance set for german vehicles (171pcs)

TN

AC 4025

Assortment of seals, plugs and valve cores for all basic air-conditioning maintenance.

Retail components available.



NO WARRANTY

**109€ Excl. VAT**

Instead of 132€ Excl. VAT\*

## Air conditioning maintenance tool set for french vehicles (214pcs)

TN

AC 4024

Assortment of seals, plugs and valve cores for all basic air-conditioning maintenance.

Retail components available.



NO WARRANTY

**139€ Excl. VAT**

Instead of 166€ Excl. VAT\*

## O-ring Standard kit

TN

AC 4056

**109€ Excl. VAT**

Instead of 139€ Excl. VAT\*



Scan to see  
the full description!



## Air conditioning maintenance kit R1234YF

TN

AC 4054

**115€ Excl. VAT**

Instead of 145€ Excl. VAT\*



### Contents:

- CO4082x4: 20 valve cores 19.0x5.12mm R1234yf
- CO4083: 5 valve cores 21.8x7.8mm R1234yf
- CO4084: 5 valve cores 22.1x9.8mm R1234yf
- CO4085: 5 valve cores 21.5.0x7.8mm R1234yf
- CO4086: 5 valve cores 20.0x7mm R1234yf
- CO4092: 5 valve cores 27.5x7.5mm
- CO4087: 5 plugs M8x1.0 short R1234yf
- CO4088: 5 plugs M8x1.0 long R1234yf
- CO4089: 5 plugs M9x1.0 R1234yf
- CO4090: 5 plugs M10x0.75 R1234yf
- CO4091: 5 plugs M10x1.25 R1234yf
- AC4048: valve core remover R12/R134a



## 4 compartments organizer for air conditioning maintenance box

TN

AC 4021

**38€ Excl. VAT**

Instead of 42€ Excl. VAT\*

Ideal for grouping different air-conditioning maintenance cabinets. Can accommodate up to 4 cabinets.



## Air conditioning valve core kit

TN

AC 4057

**89€ Excl. VAT**

Instead of 99€ Excl. VAT\*

### Contents:

- 20 valve cores 19.0x5.12mm (CO 4010)
- 10 valve cores 21.5x7.8mm (CO 4017)
- 5 valve cores 20.0x7.0mm (CO 4018)
- 5 valve cores 18.7x6.0mm (CO 4028)
- 5 valve cores 21.8x8.0mm (CO 4029)
- 5 valve cores 22.1x9.8mm (CO 4084)
- 5 valve cores 18.35x5.1mm (CO 4058)
- 5 valve cores 27.15x7.8mm (CO 4059)
- 5 valve cores 18.5x6.5mm (CO 4060)
- 5 valve cores 19.0x5.12mm - HFO1234yf (CO 4082)
- 3 valve cores 21.8x8.0mm - HFO1234yf (CO 4083)
- 3 valve cores 22.1x9.8mm - HFO1234yf (CO 4030)



# SUMMER SELECTION

## Pneumatic spring compressor 1.2T with articulated jaws

TN

OP 2031

Specially designed to fit and securely hold springs with widely spaced coils. Thanks to the innovative articulation system, adjustment is automatic when the spring is compressed.

**2099€** Excl. VAT\*

### Specifications:

- height: 1400mm
- ground connection:
- Length: 650mm
- width: 400mm
- operating pressure: 6bar/mini 8bar
- compression force 1226kg
- weight: 62kg



### OFFERED

Spring locking clamp  
27mm

OM 1180 79€ Excl. VAT\*



**1.2T**



## Reinforced pneumatic spring compressor (2.4T) with articulated jaws

TN

OP 3221

Specially designed to fit and securely hold springs with widely spaced coils. Thanks to the innovative articulation system, adjustment is automatic when the spring is compressed.

**2899€** Excl. VAT\*



### Specifications:

- height: 1400mm
- ground connection:
- Length: 650mm
- width: 400mm
- operating pressure: 6bar/mini 8bar
- compression force 1226kg
- weight: 62kg



### OFFERED

Spring locking clamp  
27mm

OM 1180 79€ Excl. VAT\*



**2.4T**



## Shock absorber head removal kit

TN

OM 1112

Specially designed for mounting and dismounting shock absorber heads, this set features through sockets for loosening and tightening the top cup nut, while holding the shock absorber piston rod to prevent it from rotating.



**99€ Excl. VAT**

Instead of 149€ Excl. VAT\*

**5**  
WARRANTY

## Universal separator for drive shaft joints

TN

OM 3411

This tool allows the bowl to be disconnected from the transmission, avoiding the stress of hammer blows.



The tool is equipped with 8 positions of locking recoil on the shaft, once locked on the shaft the original nut, will constrain to pull out the bowl.  
Suitable for Ø100mm bowl

**82€ Excl. VAT\***

OFFERED

Cardan shaft  
extractor

OM 3511 12€ Excl. VAT\*



TN

**2**  
WARRANTY

## Digital strobe light

TN

AC 5048

The strobe lamp is connected to a candle wire by an induction sensor. It produces a flash synchronized with the ignition point.

This powerful flash, directed at the ignition marks engraved on the flywheel rim or damper pulley, "freezes" the position of these marks in relation to the fixed index, making it easy to check whether the ignition advance setting is correct or not. The exact ignition point can therefore be set with great precision by varying the phase shift from the device.

CAUTION: The exact parameters for setting the Engine's ignition timing can usually be found in the manufacturer's technical manual.



**89€ Excl. VAT**

Instead of 99€ Excl. VAT\*

**2**  
WARRANTY



## Maintenance station for automatic gearbox

TE

HU 8011

The essential automatic equipment for 100% ATF oil replacement. The HU 8011 station guarantees precise, assisted preventive maintenance, effectively extending the life of automatic transmissions.

This assisted maintenance station is a preventive tool. Its role is to extend the life of automatic gearboxes, which are difficult to repair and have a very heavy financial cost if they have to be replaced. The role of oil in an automatic gearbox is fundamental, and most problems can be avoided with appropriate preventive maintenance. Unlike a traditional gravity oil change, which will remove 60% of the residue, our team of specialists has specially designed this system to clean the entire interior of the automatic gearbox without disassembly. Simple to use, fully automatic, and thanks to its included technical data (12,000 models) and 24 fitting solutions compatible with the majority of vehicles on the market, it assists you every step of the way. You can easily monitor, update and control the machine via the included removable LCD tablet.

**Features :**

- 100% ATF oil replacement
- internal washing of automatic gearbox
- internal rinse with additives
- internal washing of heat exchanger

**Contents:**

- automatic station
- LCD tablet
- access to technical procedures
- integrated drawer with 24 sets of hydraulic fittings:  
HU 8012, HU 8013 , HU 8014, HU 8015, HU 8016 , HU 8017, HU 8019, HU 8020, HU 8021, HU 8022, HU 8023 , HU 8024, HU 8026, HU 8037, HU 8039, HU 8043, HU 8044, HU 8045, HU 8046, HU 8066, HU 8071, HU 8073, HU 8087, HU 8089



**6990€ Excl. VAT\***

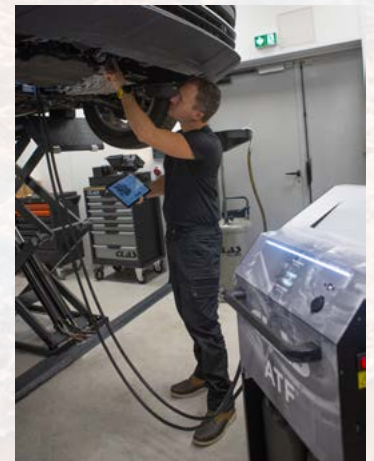

## Gearbox refilling device with adapters

TN

HU 8005

**Specifications:**

- manual flow: 0.1l/pump
- pneumatic flow: 0.18 to 0.2l/sec
- maximum pressure: 7bar
- tank discharge valve: 1bar
- supplied with set of 15 fittings
- graduated bowl
- 60psi pressure gauge
- carrying handle
- 1/4-turn valve on supply and discharge
- remote filler cap



**379€ Excl. VAT**

Instead of 449€ Excl. VAT\*



## Master timing tool set PSA generation 1

TN

OM 6200



172€ Excl. VAT\*



Models:

Fiat/Lancia: Ulysse, Scudo, Ducato, Zeta, Phedra  
 Ford: Fiesta, Fusion, Focus, Focus C-Max  
 Citroën: C15, C1, C2, C3 Pluriel, C4, C4 Picasso, C5, C6, C8, DS3, DS4, DS5, Xantia, Xsara, Xsara Picasso, Evasion, Berlingo, Jumpy, Jumper, Saxo, ZX, XM, Evasion, AX  
 Peugeot: 107, 1007, 206 cc, 207, 208, 306, 307 cc, 308, 406, 407, 508, 607, 806, 807, Partner, Expert, Boxer, 206, 106, 605, 205, 405  
**Engines:**  
 Fiat/Lancia: 2.0, 2.2 JTD  
 Ford: 1.4, 1.6 Duratorq TDCI  
 PSA: 1.0, 1.1, 1.4, 1.6, 1.6 16V, 1.4, 1.6 HDI, 1.8, 1.8 16V, 2.0, 2.0 turbo, 1.9 D, 2.0 HDI, 2.2 HDI, 1.8 16V, 2.0 16V



## Complete PSA / Toyota timing tool set generation 2<sup>©</sup>

TN

OM 6210



239€ Excl. VAT\*



Models:

PSA: 1007, 108, 206, 206 CC, 207, 207cc, 208, 2008, 301, 307, 308, 308cc, 308, 3008, 407, 407 Coupé, 5008, 607, Partner III  
 C2, C3, C3 Picasso, C3, C3111, C4, C4 Picasso, C4, C4 Picasso, Grand Picasso, C5 II, C5 III, C6, Berlingo III, DS3, DS3 Cab, C-Elysée, Xsara Picasso  
 Mini: One (R56), Mini Cooper (R55/R56), Mini Cooper S (R55/R56), Cooper/S, Mini One, Clubman  
 Jaguar: S-Type, XF, XJ, XJ6  
 Land Rover: Range Rover Sport, Discovery 3 and 4  
 Toyota: Aygo, Proace City  
**Engines:** 1.0, 1.2i, 1.4, 1.4 VTI, 1.6, 1.6 VTI, 1.6 THP, 1.6 diesel, 1.8, 2.0, 2.5, 3.0 L, 2.7 D/TDV6/HDI/TDVi



## Master timing tool set Renault / Nissan / Opel / Volvo generation 1

TN

OM 6100



249€ Excl. VAT\*



Models:

Renault: Clio 1-2-3-4, Clio Sport 1-2-3, Mégane 1-2-3, Master 1-2, Mégane Scénic 1-2-3, Vel Satis 1-2, Avantime, Kangoo 1-2-3, Laguna 1-2-3, Espace 1-2-3, Trafic 1-2, Wind, Modus, Twingo, Koleos  
 Dacia: Logan, Duster, Sandero, Dokker  
 Nissan: Note, Qashqai, Micra, Interstar, Primastar, Kubistar, Almera, Primera  
 Opel: Vivaro, Movano  
 Volvo: S 40, V 40  
**Engines:** 1.2, 1.2 16V, 1.4, 1.4 16V, 1.5 DCI, 1.6, 1.6 16V, 1.6 D, 1.7, 1.8, 1.8 16V, 1.9 TD, 1.9, 1.9 DCI, 1.9 DTI, 1.9 CDTI, 2.0, 2.0 16V, 2.1 TD, 2.2, 2.2 DCI, 2.2 DTI, 2.2 TD, 2.5 DCI, 2.5 CDTI, 2.5 TD, 2.8 D

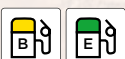

## Complete Renault / Nissan / Opel / Volvo timing tool set generation 2<sup>©</sup>

TN

OM 6110



289€ Excl. VAT\*



Models:

Renault: Clio II, Espace 4 and 5, Fluence, Koleos, Laguna, Laguna 2, Latitude, Master, Megane, Megane 2, Scenic, Scenic RX4, Scenic 2, Grand Scenic 2, Trafic 2, Vel Satis  
 Mercedes: Class C, Vito  
 Mitsubishi: Carisma  
 Nissan: Navara NP300, Primastar X83, Qashqai 1 and 2, X-Trail  
 Opel: Arena, Vivaro-B  
**Engines:** 1.4, 1.6, 1.8 16v, 2.0 16v, 1.6, 2.0, 2.3, 2.5, 3.5, 1.9DTI/TD, 2.3DCI/CDTI

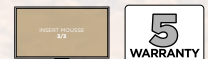

# SUMMER SELECTION



## Master timing tool set Ford/Mazda/Volvo

TN

OM 6600



249€ Excl. VAT\*

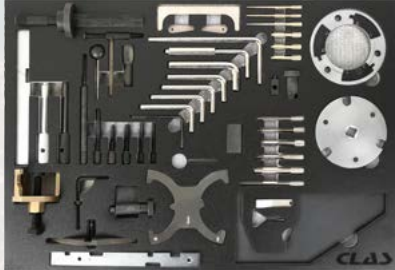

Models:

Ford: Fiesta, Fusion, Courier, Escort, Focus, Focus C Max, Puma, Mondeo, Sierra, Transit, Connect, Cougar, Courier, Courier Kombi, Galaxy, C-Max, Orion, Tourneo Connect, Transit, Transit Connect  
VW: Sharan  
Seat: Alhambra  
Mazda: 121  
Volvo: S40, V50 petrol, 1.8 D, 1.8 TD, 240 D, 740 D, 760 D, 940 D, 960 D Turbo  
**Engines:** 1.2, 1.4, 1.6, 1.6 16V, 1.7 16V belt, 1.8-2.0 16V (belt and chain), 1.4, 1.6 16V Focus and Mazda 121, 1.6 Duratorq TDCI, 1.8 D, 1.8 TD (88-00), 1.8 DI (belt) (98-04), 1.8 TDCI (belt) (01-04), 1.6 D, 1.9 TDI, 2.5 D/TCI (belt), 1.9 TDI, 2.5 D/TCI (belt), 1.25, 1.6 TI-VCT, 1.6 SCTI, 1.4 D TDCI, 1.6 D TDCI, 1.8 D, 1.8 D TCI, 1.8 D TDDI, 1.8 D TDCI, 1.8 D Turbo, 1.8 D Turbo, 1.9 D TDI PD, 1.9 D TDI PD, 2.0 D TDCI, 2.2 TDCI, 2.5 D, 2.5 D Turbo, 2.0, 2.2, 2.4 Duratorq TDCI 16V, 1.4 D TDCI, 1.6 D 8V, 1.6 D 16V



## Master timing tool set VAG

TN

OM 6300



279€ Excl. VAT\*



Models:

Audi: 80, A1, A2, A3, A3 cabrio, S3, A4, A5, A6, TT, Q5  
Seat: Arosa, Ibiza, Cordoba, Leon, Toledo, Alhambra, Altea, Inca (99-04)  
Skoda: Fabia, Octavia, Superb  
VW: Lupo, Polo, Fox, Golf, Bora, Jetta, Golf Plus, Golf estate, Passat, Beetle, Touran, Sharan, Caddy, Caddy Maxi,  
Transporter, Golf VI cabrio, Tiguan  
Ford: Galaxy  
**Engines:**  
Petrol: 1.2 TSI, 1.4, 1.4 TSI, 1.6 16V, 1.2 9V-12V 3cylinder, 1.4, 1.6 FSI (chain), 1.8, 1.8 16V, 1.8T, 2.0 16V, 2.0 FSI/TFSI (belt)  
Diesel: 1.2 TDI PD, 1.4 TDI PD, 1.9 TDI 75-90-110 PF, 1.9 SDI 75-90-110 PF, 1.9 TDI 105-130-150 PF, 2.0 TDI PD, 2.0 TDI DPF 140-170 PF, 2.5 TDI V6



## Master timing tool set Opel/Chevrolet/Saab/ Fiat/Lancia/Suzuki/ Ford

TN

OM 6500



299€ Excl. VAT\*



Models:

Opel: Corsa B,C, Combo, Tigra, Agila, Tigra B, Meriva, Astra F,G, H, Astravan, Speedster/VX220, Zafira A, B, Vectra B, C, Signum, Omega B, Sintra, Frontera A, B, Astravan, Kadett, Ascona, Omega, Monterey, Antara, Croma, Speedster/VX220  
Chevrolet/Daewoo: Epica, Captiva, Nubira, Lacetti, Evanda  
Saab: 9-3, 9-5 (98-04)  
Alfa: 145, 146, 147, 156, 159, 166, GT, Crosswagon Q4  
Fiat: Punto, Grande Punto, Bravo/Brava, Marea, Weekend, Stilo, Doblo/Cargo, Multipla, Idea, Panda 150  
Lancia: Ypsilon, Musa, Lybra, Thesys  
Suzuki: Ignis, Swift, Wagon R+  
Ford: Ka  
**Engines:** 1.0 12V, 1.0 16V, 1.2 16V, 1.4, 1.6, 1.2-1.4 16V (Chain), 2.0, 2.0 Turbo, 2.2 DI, 2.0-2.2 16V, 1.6 16V, 1.8 16V, 2.0 16V, 2.2 16V, 1.3 JTD MultiJet, 1.3 CDTI, 1.3 TDCI, 1.6 MultiJet, 1.9 JTD, 1.9 MultiJet, 2.4 JTD, 1.9 CDTI, 2.0 MultiJet, 1.5 D, 1.5 TD, 1.7 D, 1.7 TD, 1.6-1.7 D, 3.0 TD, 3.1T D, 2.0-2.2-2.4 TD, 2.0-2.2 DI, 2.0 TDCI, 2.0 D VCDI, 2.2 16V (double camshaft)



## Master timing tool set Fiat / Alfa / Lancia / Opel / Suzuki / Ford

TN

OM 6400



299€ Excl. VAT\*



Models:

Alfa: 145, 146, 147, 155, 156, Spider, GTV, TS, GT, 159, 166, Crosswagon Q4  
Fiat: Punto, Grande Punto, Brava/Bravo, Marea, Weekend, Stilo, Doblo/Cargo, Idea, Panda, Multipla, Palio, Stilo, 500  
Lancia: Lybra, Ypsilon, Thesys, Musa,  
Opel: Corsa, Agila, Meriva, Combo, Vectra, Zafira, Astra, Insigna, Signum 1.9 CDTI  
Suzuki: Ignis, Swift, Wagon R+  
Ford: Ka  
**Engines:** 1.2 8V, 1.2 16V, 1.4 16V, 1.6 16V, 1.6 MultiJet, 1.9 JTD, 1.9 JTD 16V, 1.9 MultiJet, 2.4 JTD, 1.9 CDTI, 2.0 MultiJet, 2.4 JTD 20V, 1.3 JTD MultiJet, 1.3 CDTI, 1.3 TDCI, 1.9 CDTI

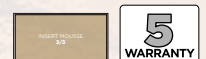
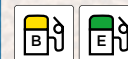

## Common rail injector tester

TN

AC 5240BL

**B.LINE**  
BUDGET SOLUTION

Covers the majority of vehicles fitted with Bosch (excluding Opel), Denso, Delphi and Siemens Common Rail injectors. Contents detect injector flow problems.

A) Engine runs without starting.  
Installing the graduated pencils allows you to diagnose :  
- if all levels are similar:  
Injectors are operating correctly.  
- if one level is significantly higher than the others (25%):  
this injector is damaged.  
The method is faster:  
- direct connection to the injector  
- fuel flows directly into the pencils.

B) Engine starts.  
We recommend using the vials.  
If excessive flow is observed in one of the vials, replace the injector connected to that vial.



**40€ Excl. VAT**

Instead of 44€ Excl. VAT\*



## Slide hammer set+injector extractor adaptors (14pcs)

TN

OM 0020BL

**B.LINE**  
BUDGET SOLUTION

Enables fast, effortless removal of injectors jammed in the cylinder head.

### Contents:

- inertia weight 3.9kg
- weight guide L.510mm
- handle L.110mm
- gimbal for better access to restricted areas
- Delphi M14x1.5 adapter
- adapter M17x1 Bosch
- adapter M20x1 Denso
- adapter M25x1 Siemens
- Siemens M27x1 adapter
- female adapter M27x1 Bosch
- hexagonal socket 10mm drive 19mm (electrode removal)
- 4 slotted hexagonal sockets 25-27-29-30mm L.100mm, 1/2" drive



**95€ Excl. VAT**

Instead of 99€ Excl. VAT\*



## 1/2" d. hex sockets set for removing diesel injector heads

TN

OM 0071



**29€ Excl. VAT\***

Instead of 50€ Excl. VAT\*



## Injector/glow plug releaser 500ml

TN

CO 1025



500 ml high-penetration degreaser for injectors and spark plugs.

**9,50€ Excl. VAT\***

Instead of 12,50€ Excl. VAT\*



# SUMMER SELECTION

## Petrol compression gauge

AC 0115

Complete with connections M10x1.0-M12x1.25-M14x1.25-M18x1.5  
Pressure gauge from 0 to 20bar  
+ universal adapters



TN

**29€ Excl. VAT**

Instead of 31€ Excl. VAT\*



## Multi-brand compression gauge petrol-diesel/DCI

AC 2018BL

**B.LINE**  
BUDGET SOLUTION

### Specifications:

- quick-connect adapter
- 400mm hose for difficult access
- 0 to 40bar pressure gauge with relief valve



TN

**165€ Excl. VAT**

Instead of 175€ Excl. VAT\*



## Oil pressure gauge

AC 4111

TN

**39€ Excl. VAT**

Instead of 45€ Excl. VAT\*



### Contents:

- 1 manometer 0 to 10bar with pressure relief
- 1300mm hose with quick-release coupling
- 90° angled quick-release coupling
- 10 oil pressure switch adapters
- for all engines (diesel and petrol)



## Universal cylinder leak detector tester

AC 0118

TN

**275€ Excl. VAT\***



The adapters supplied with the cylinder leak tester fit all spark plug shafts (10, 12, 14, 18mm) and the long adapters (220mm M12, M14) are particularly useful for deep-seated spark plugs.



## Wireless-compatible digital multi-pressure tester

TN

AC 0920

NEW

1590€ Excl. VAT

Instead of 1615€ Excl. VAT\*

NEW VERSION of our famous AC 0800 digital pressure gauge, now compatible with the AC 0925 wireless option for easy road tests. This upgraded version also features a more powerful processor, completely redesigned menus for optimum ergonomics, increased memory, and fast USB-C charging.

This universal digital measurement tool can be used to check all types of pressure, whether pneumatic or hydraulic, in order to compare the physical and real values of the circuit with those transmitted by the sensors via the diagnostic readout. Thanks to this comparison, you can quickly identify the source of a fault, whether mechanical or electrical.



All options on clas.com



### Contents:

- 1 tester 7" color TFT display with resistive touchscreen
  - battery: lithium polymer 3.7V / 2000mA
  - intelligent USB battery charging with LED indicator
  - pc connection via USB port
  - aBS case with rubber bumpers
  - all screws mounted on brass inserts
  - 1/4-thread brass insert on rear for mounting bracket
  - 1 sensor 0/300 bar (2m)
  - 1 -1/+3 bar sensor (2.90m)
  - 1 universal diesel compression adapter
  - 1 universal gasoline compression adapter
  - 8 extremely flexible OEM quick connectors
- All components available at retail price



## Vacuum pump and fuel control set

TN

AC 0001BL

This gasoline pump kit not only checks mechanical pumps, but also hoses, and tests valves, intake manifolds and vacuum hoses for leaks.

- allows vacuum settings from 0 -28inHg or 0-70cmHg
- allows pressure settings from 0-0.7Kg/cm2 or 0-10PSIG



15€ Excl. VAT

Instead of 32€ Excl. VAT\*



# SUMMER SELECTION

## Pressure vacuum pump (-0.5/+3bar)

TN

AC 0550BL

**B.LINE**  
BUDGET SOLUTION

Optimize your workshop diagnostics with the AC 0550BL pressure/vacuum pump from CLAS Équipements, the essential tool for precise control of pneumatic and vacuum systems on light, commercial and heavy-duty vehicles.

**Contents:**

- 1 set of 5 Nozzles
- 1 set of 4 hose extensions 4 nozzles
- collection vessel with 2 lids
- 2 x 500mm extensions



**69€ Excl. VAT**

Instead of 89€ Excl. VAT\*

**2**  
WARRANTY

## Smoke leak detector

TN

AC 0411BL

**B.LINE**  
BUDGET SOLUTION

Thanks to its compact size, this machine is easy to transport, enabling it to be used throughout the workshop. Its integrated compressor eliminates the need for an air supply.

Compatible with the majority of the vehicle fleet, and connected to the battery terminals, it enables rapid diagnosis of the vehicle's closed circuits (turbo, exhaust, cooling, etc.).

To detect micro-leaks in :

- vacuum (excluding EVAP valves, components and diaphragms not resistant to 1bar pressure)
- exhaust
- turbo insulation (excluding pneumatic Wastgate, may involve certain risks 1bar pressure)
- oil sump
- intake
- cooling

This device considerably reduces leak detection time by releasing a fine, opaque smoke that can be instantly identified even on the smallest leaks.

No risk to user or vehicle.



**259€ Excl. VAT\***



**2**  
WARRANTY

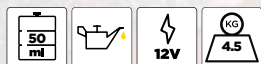

## 5-in-1 diesel cleaner decalcifier 1l

TN

CO 1072



**27€ Excl. VAT**

Curative product to be added to fuel

Instead of 29€ Excl. VAT\*



**NO**  
WARRANTY

## 300ml cooling leak sealer

TN

CO 1012



**7€ Excl. VAT**

Seals coolant circuit leaks, seals radiators and water pumps, prevents overheating.

Instead of 9,50€ Excl. VAT\*



**NO**  
WARRANTY

## Electric/hybrid vehicle consignment set

TN

OE 0376

This kit is dedicated to professionals working on live electrical work.  
Dedicated to consignment officers.

920€ Excl. VAT\*



### Contents:

- EG3110: tool bag with shoulder strap
- OE3010: VAT safety tester
- OE3011: IP2X black probe
- OE3012: IP2X red touch point
- OE0562: lockout bag
- OE0564: lockout padlock
- OE0563: locking disc
- OE0757: insulating bag for 210mmx130mm connector
- OE0758: insulating bag for 305mmx225mm connector
- EG0031: flying hazard cover
- EG0035: electrical danger sign micro suction cup 200mm
- OE0764: self-gripping insulating sheet 660mmx360mm
- OE0840: 1000V insulated tool set for hybrid and electric vehicles (27pcs)



OFFERED

TN

## Marking/work area signaling set

EG 0012 179€ Excl. VAT\*

Compatible with : B1L, B1VL, B1TL, B2L, B2VL, B2TL, BCL, BEL, BRL, B1XL, B2XL.



NO WARRANTY

# SUMMER SELECTION

## Hybrid and electric vehicles intervention set

TN

OE 0355

**Contents:**

- OE3010: VAT safety tester
- OE0840: 1000V insulated tool set for hybrid and electric vehicles (27pcs)
- OE0844 (x4): insulated fixing pliers
- OE0874: insulated universal pliers

**599€ Excl. VAT**

Instead of 669€ Excl. VAT\*



OE 0840

OE 0755

OE 0844

OE 3010

## Electric arc protective jacket

TN

**99€ Excl. VAT**

Instead of 139€ Excl. VAT\*

REF	TAILLE
OE 0470	S
OE 0471	M
OE 0472	L
OE 0473	XL
OE 0474	2XL

**NEW**



50 washes

**Features:**

- Fabric composition: 75% Cotton, 24% Polyester, 1% Anti-static
- Fabric weight: 315g/m<sup>2</sup>
- High collar
- Closure: Injected plastic zipper hidden under snap placket
- Pockets: 1 patch breast pocket, asymmetrical breast pocket, 2 side pockets (all under snap flap or under flap)
- Fit : Raglan sleeves and snap-adjustable cuffs
- Chest loops for gas detectors, inside marking bib
- Advice:

**Standards**

- EN ISO 11612:2015 : Protection against heat and flame (A1, A2, B1, C1, E3, F1)
- EN ISO 11611: 2015 : Protective clothing for welding and related techniques (Class 1, A1, A2)
- EN ISO 1149-5:2018 : Electrostatic properties (Antistatic)
- IEC 61482-2: 2020 : Protection against the thermal hazards of an electric arc (APC1)
- EN 13034:2005 + A1: 2009 : Limited protection against liquid chemicals (Type 6)
- EN 15797: Clothing suitable for use in industrial laundries

## Electric arc protection pants

TN

**79€ Excl. VAT**

Instead of 109€ Excl. VAT\*

REF	TAILLE
OE 0480	38
OE 0481	40
OE 0482	42
OE 0483	44
OE 0484	46
OE 0485	48
OE 0486	50

**NEW**



**Specifications:**

- arc flash class 1, ATPV 12 cal/cm<sup>2</sup>.
- standards: EN 13034: 2005 / EN 1149-5: 2008 / EN ISO 11611: 2007 / EN ISO 11612: 2008 / IEC 61482-2: 2009 (CLASS 1 AND ATPV 12 CAL/CM<sup>2</sup>)
- Contents: 79% cotton, 20% polyester, 1% antistatic fiber, 300 gr/m<sup>2</sup>.
- ATEX zone

## Dual laser headlight adjustment device

TN

AC 2013

**Functions :**

- 0-4% drawdown measurement and control
- lateral adjustment control  $\pm 5\text{cm}/10\text{m}$
- lighting power measurement 0-150klux/1m, 0-240lux/25m
- intervention on headlights (Xenon, Halogen, LED...), fog lights

**Specifications:**

- laser-type aligner (SA2037) compliant with EN 60825 standard
- digital luxmeter
- removable aluminum column graduated from 20 to 150cm
- sliding adjustment mechanism
- thermoplastic housing with adjustable inclination
- laser aligner power supply: 3 x 1.5V batteries (included)
- dimensions: L.712xW.580xH.1810mm
- UTAC NFR 63801 standard



SA 3032 Rails and wheels kit

999€Excl. VAT

**890€Excl. VAT**

Instead of 999€Excl. VAT\*



**2**  
WARRANTY

## Dual laser/camera headlight adjuster

TN

AC 3010

- automatic beam control and diagnostics: low beam, high beam and fog lamps, whatever the type of light source (**laser, led, Matrix led, Xenon, Halogen, etc.**)

**and type of management (ILS Intelligent Light System, AFS Adaptive Front lighting System, DLS Dynamic Light System, DLA Dynamic Light Assist)**

- provides automatic camera-based control and measurement of the downward and lateral beam. It also measures lighting power.
- cross laser housing centering.
- UTAC NFR 63-801 compliant

**Specifications:**

- measuring range: 0-6% (accuracy +/- 0.1%)
- Lateral 0-10% (accuracy +/- 0.2%)
- luminous intensity: 150kcd
- 360° rotating Aluminum column
- counterweight rise-and-fall
- 3-axis inclinometer electronically compensates for ground irregularities
- adjustable castors compensate for large differences in floor level
- case height sensor
- 5.7" color LCD touchscreen
- integrated printer: registration no./date/test result
- 12V rechargeable battery
- automatic sleep mode
- quick and easy software updates (via USB key)
- connections: RS232
- communication protocols: Net1, Net2
- dimensions: L.695xW.660xH.1780mm



SA 3032 Rails and wheels kit

999€Excl. VAT

**5290€Excl. VAT**

Instead of 5495€Excl. VAT\*

**2**  
WARRANTY

# SUMMER SELECTION

## Pair of suction cups Ø115mm

TN

OC 0550BL **B.LINE**  
BUDGETSOLUTION

### Specifications :

- toggle suction cups to adapt to different glass curvatures
- lever locking
- handling handle
- capacity: 60kg
- suction cups Ø115mm
- supplied with quick-release ratchet strap
- strap length: 4.7m
- strap width: 2.5cm



**29€ Excl. VAT**

Instead of 49€ Excl. VAT\*

## Ratchet windshield cutter

TN

OC 6498

### Specifications:

- universal: compatible with nylon and steel wire (all types: braided, square and triangular)
- 200kg pulling capacity (compared to 100kg for steel wire)
- up to 8 cuts before changing nylon wire



**690€ Excl. VAT**

Instead of 899€ Excl. VAT\*

## Bodywork stand with tarpaulin

TN

OC 0724

### Specifications:

- capacity: 270kg
- folding galvanized steel frame (Ø32mm x 1.2mm)
- height: 1040mm
- width: 1080mm
- working range from 680 to 1040mm (adjustable chains)
- PU support plug
- weight: 6.4kg



**59€ Excl. VAT**

Instead of 79€ Excl. VAT\*

## Pneumatic straightening square

OC 0800

Designed for maximum bodywork efficiency, the CLAS straightening column stands out for its robustness, stability and ease of use. Its integrated Venturi system ensures powerful anchoring to the ground, even on the smoothest surfaces.

Features :

- Integrated Venturi system for floor fixing.
- Wide, high-adhesion seal, effective even on uneven floors.
- Pulling capacity: 600 kg.
- Maximum height: 1.60 m.
- Winch equipped with high-strength chain.
- Reinforced structure for constant precision.
- Weight: 49 kg, with castors for easy movement.
- Supplied with strap and pull hook.
- Compatible with CLAS OC 0830 suction cup base (optional)

Delivered complete, it includes an extension bar, a pull strap and a reinforced hook, for immediate adaptation to all your work configurations.

Thanks to its integrated Venturi anchor with wide joint, the column sucksers instantly to the ground, guaranteeing optimum stability, even on uneven surfaces. It can also be combined with the OC 0830 anchoring base for even greater support.

- 1 draft tube with integrated Venturi system
- 1 large, high-resistance suction cup gasket
- 1 chain winch
- 1 pull strap
- 1 pull hook
- Transfer wheels

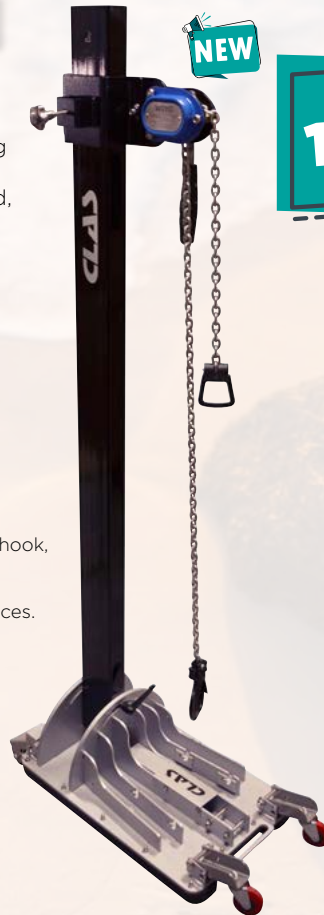

**1099€ Excl. VAT\***

TN

2 WARRANTY

## 210mm 130kg electric suction cup pack

OC 0690X2

Caractéristiques :

- dimensions du produit : 210 mm
- force de traction sécuritaire : 130 kg
- mode d'alimentation : batterie lithium 3,7 V
- interface de charge : USB Type-C
- capacité de la batterie : 1200 mAh\*1
- temps de charge : 3 heures
- autonomie : 4 heures
- durée de la batterie sans chargement : plus d'une semaine
- compartiment à batterie à l'arrière, permet de remplacer les batteries au lithium à tout moment



~~178€ Excl. VAT\*~~

**159€ Excl. VAT**

The bundle

79,50€ Excl. VAT per unit



2 WARRANTY

## Pneumatic knife

OP 0500

Supplied with connector and 1 blade OP0557



**190€ Excl. VAT**

Instead of 229€ Excl. VAT\*

TN

2 WARRANTY

# SUMMER SELECTION

## Kit of 13 dent removal rods and accessories

TN

OC 8200

24-piece assortment of 13 paintless dent removal rods and accessories. Ideal for straightening hail dents, minor door dings and other impact marks. Supplied in carry bag.

NEW

229€ Excl. VAT

Instead of 249€ Excl. VAT\*



2 WARRANTY

## Expert dent removal kit 63 pieces

TN

OC 8300

Assortment of paintless dent repair rods. Ideal for straightening hail dents, minor door dings and other impact marks. Long and short rods in a variety of shapes make it easy to remove dents from the inside

NEW

499€ Excl. VAT\*



2 WARRANTY

## Bodywork service

TN

OC 0720

The perforated tray, adjustable in height from 95 to 145cm, is designed to accommodate the dent removal rods. Its 4 castors, 2 of which have brakes, make it easy to handle and stabilize.

NEW

169€ Excl. VAT

Instead of 199€ Excl. VAT\*



2 WARRANTY

FROM APRIL 1 TO JULY 31, 2026

**Camel stretch multi-pocket pants with knee reinforcement** TN

**62€Excl. VAT\***

REF	TAILLE
AP 8301	36
AP 8302	38
AP 8303	40
AP 8304	42
AP 8305	44
AP 8306	46
AP 8307	48
AP 8308	50
AP 8309	52



NO WARRANTY

**Grey/Black sleeveless down jacket** TN

**62€Excl. VAT\***

REF	TAILLE
AP 7702	S
AP 7702	M
AP 7703	L
AP 7704	XL
AP 7705	2XL
AP 7706	3XL



NO WARRANTY

**Black stretch multi-pocket shorts** TN

**57€Excl. VAT\***

REF	TAILLE
AP 7501	36
AP 7502	38
AP 7503	40
AP 7504	42
AP 7505	44
AP 7506	46
AP 7507	48
AP 7508	50
AP 7509	52



NO WARRANTY

**Camel stretch multi-pocket shorts** TN

**57€Excl. VAT\***

REF	TAILLE
AP 8501	36
AP 8502	38
AP 8503	40
AP 8504	42
AP 8505	44
AP 8506	46
AP 8507	48
AP 8508	50
AP 8509	52



NO WARRANTY

\*Recommended retail prices valid from January 1, 2026, to December 31, 2026. Photos are for illustrative purposes only - If no size is specified when ordering, CLAS reserves the right to deliver a random size. In the event of a stock shortage, CLAS reserves the right to deliver a gift of equivalent value.

# SUMMER SELECTION

## Safety sneakers camel Black

TN

NEW

82€ Excl. VAT

Instead of 99€ Excl. VAT\*



### Specifications:

- standard: EN ISO 20345:2022 + A1:2024
- category: SIPS - SR - FO - ESD
- outsole: non-slip, antistatic

REF	TAILLE	REF	TAILLE
AP 3139	39	AP 3144	44
AP 3140	40	AP 3145	45
AP 3141	41	AP 3146	46
AP 3142	42	AP 3147	47
AP 3143	43		

NO WARRANTY

## Safety sneakers duo Black

TN

99€ Excl. VAT

Instead of 109€ Excl. VAT\*



### Contents:

- E.V.A rubber sole + SRC (300°C resistant)
- standards: EU 2016/425, EN ISO 20345:2011 or EN ISO 20347:2012

This Class 3 (S3) safety shoe features a high-quality inner lining for enhanced breathability.

REF	TAILLE	REF	TAILLE
AP 7039	39	AP 7044	44
AP 7040	40	AP 7045	45
AP 7041	41	AP 7046	46
AP 7042	42	AP 7047	47
AP 7043	43		

NO WARRANTY

## Safety sneakers trio grey

TN

99€ Excl. VAT

Instead of 109€ Excl. VAT\*



### Contents:

- E.V.A rubber sole + SRC (300°C resistant)
- standards: EU 2016/425, EN ISO 20345:2011 or EN ISO 20347:2012

This Class 3 (S3) safety shoe features a high-quality inner lining for enhanced breathability.

REF	TAILLE	REF	TAILLE
AP 8039	39	AP 8044	44
AP 8040	40	AP 8045	45
AP 8041	41	AP 8046	46
AP 8042	42	AP 8047	47
AP 8043	43		

NO WARRANTY

## High-top safety sneakers camel Black

TN

NEW

119€ Excl. VAT

Instead of 129€ Excl. VAT\*



### Specifications:

- standard: EN ISO 20345:2022 + A1:2024
- category: S3S - HRO - SR - FO - ESD
- sole: EVA + SR + FO + HRO rubber (heat-resistant up to 300°C)

REF	TAILLE	REF	TAILLE
AP 3239	39	AP 3244	44
AP 3240	40	AP 3245	45
AP 3241	41	AP 3246	46
AP 3242	42	AP 3247	47
AP 3243	43		

NO WARRANTY

## Sneakers camel grey

TN

NEW

82€ Excl. VAT

Instead of 89€ Excl. VAT\*



### Specifications:

- standard: EN ISO 20347:2022 + A1:2024
- category: O1 - SR - FO - HRO
- sole: EVA + SR + FO + HRO rubber (heat-resistant up to 300°C)

REF	TAILLE	REF	TAILLE
AP 3039	39	AP 3044	44
AP 3040	40	AP 3045	45
AP 3041	41	AP 3046	46
AP 3042	42	AP 3047	47
AP 3043	43		

NO WARRANTY